

KINGDOMS
OF
FLAME

BY ARCHAEUS BARON

Kingdoms of Flame

A Grimoire of Black Magick, Evocation, and Sorcery

All rights reserved. No part of this book may be reproduced or utilized in any form or by any means, electronic or mechanical, without permission in writing from the publisher,

Text copyright © 2008 Archaelus Baron
Grand Emissary of the Eighteen Flames
Ordo Ascensum Aetyrnalis

First edition © 2005 Ixaxaar Occult Literature
Second edition © 2007 Ixaxaar Occult Literature
Third edition © 2008 Ixaxaar Occult Literature
Layout designed by A.I. / Ixaxaar
Frames originally designed by William Morris and modified for
the use of Ixaxaar by I.E.T.T. / Ixaxaar

<http://www.ixaxaar.com>

Introduction

In the month of November, 2000, I was given a strange text by three strange men, with the mission of deciphering and finding the practical applications of it within an occult setting. Working with the training and the resources of the Ordo Ascensum Aetyrnalis, I completed this task the following year, releasing the results in a thesis manuscript to the Order.

I have entered all of the gateways, summoned ail of the entities and performed all of the rites that were contained in that text. I have seen and have proven without doubt that these beings do exist, that these Kingdoms do hold reign in that region called Regnum Spiritus, between this world and the next.

The Grand Emissaries of the Ordo Ascensum Aetyrnalis and I integrated the methods, which I discovered in my time with Grimoire, into the magickal system of the O.A.A. Having proven its efficacy and potency within the ranks of the Order, we have collectively decided to release the Grimoire to the public.

Herein you will find the notes that were made as I tempted the beings within to divulge their every last secret. You will be privy to accounts of spiritual phenomenon as they manifested before my eyes. You will learn those things that I found to work, and those that didn't. My fallacies and successes are laid out here, as well as the formulae that led to unlocking the fullness of the Grimoire.

More importantly, we are releasing within these pages the original information from the Grimoire itself. Entities whose names have rarely before been called, whose images have taken form before very few eyes, whose powers have scarcely been set into effect on this earth are listed in these pages, along with their sigils and the attributes of each one. The Squares and the Gateways are given, unaltered and pulsating with energy, waiting to be opened. And an

arcane language that sends a Shockwave into the very fabric of reality.

It was never made known to me or any other with which I have spoken whom the original authors of this book were. Some Initiates believe that it was personally written by the Grand Demon Martal or Satagraal. Some say that it was the Grand Angel, Enkidorat. More likely, it is the work of one who came before me, a Grand Emissary of the Eighteen Flames, who set down on paper the most basic information pertaining to these secrets.

We offer this Grimore in hopes that some true aspirants may be led in Ascent by it. At the same time, we realize that it may be misused by many dark Magicians. Either way, we allow the Wyrld of the Aeon to direct the powers of the Path, and we await the violet whirlwind that will ensue.

The Skeleton Cipher

I had the fortune, while young, to have family that studied and lived under the spiritual canopy of an esoteric religious Order, the Ordo Ascensum Aetyrnalis. The Order was, at that time, strictly exclusive and kept hidden in every aspect from all but one's immediate family. As such, each independent cell that operated within the structure of the Order were linked in no superficial way, creating a large organization whose network was quite literally invisible to the uninitiated eye.

The details of my conception and birth into this world are and have always been vague and scattered, both mother and father vanishing shortly after. Ergo, it was the family that took me in whom I here refer to as "my family," and who served as my foreordained link to the Ordo Ascensum Aetyrnalis.

There were many mysteries concerning the Order for which there were no reasonable, direct questions that could be formulated, nor would any answers be given by any of its adherents. As a child I would ask and ask, then ask some more. The man that had become my father was unable to supply any direct answers, but instead would state, "The only way a person can discover these things is to experience them." He would then begin to guide me, at first, through simple visualizations and directed imagery that would allow me to experience that which I was seeking. In such, the essence of the thing would possess a shimmering clarity in my being, although the detail and context of it would be lost.

A good deal of my childhood was spent in this manner, learning directly from my father's direction all that I desired to know. With each question asked, a new and more profound spiritual experience would fall upon me, the intensity of the guided meditations growing each time to the eventual point of full ritual

and communication with those beings and powers that lie just outside of man's normal range of sensation.

It was on my twelfth birthday that my father took me in his car for a long drive. As I rode in the passenger seat, wondering where we were headed, my father and I chatted, the subject seeming to linger on the spiritual growth that I had fostered in my young years. He kept saying, in different words, that I could do so much if only I had better instruction, and that once I began, all obstacles would melt from my path.

Lost in the obscurity of his words, I was startled to look up and notice that we were parked in front of a large, brick house. The property was surrounded by a wrought iron fence and enormous hedges, the third and top floor being the only one visible from the street. There were many other surrounding houses the size of this one, but none stood out with a ringing sensation as this one did. It seemed so very out of place, as if it were from some other planet, dropped from the sky right onto an empty property and had since been undisturbed.

Looking at my father in question, and perhaps in some sort of unknown fear, he smiled and said "Go on inside. Someone is waiting for you there. I'll be right here in the car when you're ready to leave." I swallowed hard, not knowing what to expect as this house mutated in my mind into the very icon of all that is forbidden.

The car door gave a drawn out, high pitched creak that I had never before noticed when I opened it. The ground appeared to be a great distance farther from the car floor than it had been before. Taking a deep breath, I closed my eyes and hopped onto the pavement. Without looking back at my father or the car, I reached behind me to swing the door closed and took my first steps towards the brick house.

I stopped in front of the wood door that guarded all the secrets of the house, and raised my fist to knock. Something that I could not

explain or even understand at that time stopped my hand. That same unknown something led my hand to the door knob and twisted it. The door opened, the creak being much deeper and more sinister than the one made by the ear door.

The house was well lit. The air smelled stale and felt terribly thick, seeming to buzz with swaying spirits and spiraling energy. I stepped inside, feeling perfectly at home in this alien world.

Not wanting - or not daring - to take my eyes off of my new surroundings, I reached behind me and swung the door closed. The motion was perhaps a bit stronger and swifter than I had projected, as the door slammed against its frame when it closed. The slam made me jump, shaking me out of the trance that this house had bespelled me with.

I noticed to my right an old man stood from a lounge chair. He had not been there before, I was sure. His attire was odd for me to see, a black robe that hung to the floor, a red symbol stitched over his heart. It was a far cry from the tee shirts and corduroy pants that I loved. He was tall and somewhat thin, a long, white beard covering his gaunt face and long white hair contrasting against the black robe. He was the ideal wizard that I had read about only in fantasy novels and had seen before only in my imagination.

"Your father has taught you many things, hasn't he?" the old wizard began his address. I nodded, although I was sure he didn't need an answer. "His lessons are easy for you, They are natural. You don't feel the need to struggle with them. You have something... you ARE something that most people could never imagine."

He was silent for a long moment, staring deep into my eyes. He seemed to be entering my Soul through them, pulling up every memory and emotion that was contained in my small body and mind. And then, he continued.

"You want to go farther, deeper." The old man grinned.

"You want to go as far and as deep as hell itself, and soar

higher than the throne of God!"

Though his words were more dramatic and specific than mine would have been, he was nonetheless right. Even at such a young age, I saw a piece of a world that most eyes were closed to, and it was a world that I longed to devour whole, to integrate each particle of it into my own being.

The spirits that lingered and watched this exchange then circled around me, whispering in my ear the words that I needed to say. They called out to me, tempting me to release ray wishes in the necessary incantation.

"Can you teach me?" I asked, trying to catch the words and silence them only after they had spilled out into the air. I tensed, having heard them myself, as if spoken by another person altogether. I had no idea what such would entail, or if the man would be able to teach me. Even more, I didn't know if I wanted to be taught by this stranger. The words were brought into my throat and shoved out of my mouth of their own will and force.

I walked away from the house that night, back towards my eager father and the creaky car door. The old wizard had arranged for me to return to the large, brick house three days of the week. There, he assured me, I would study with an Initiate of the Tenth Degree of the Ordo Ascensum Aetyrnalis. I was told that with each passing lesson I would be challenged in a different and more difficult way, and that I would learn from many different mentors until finally I had reached the Eighteenth and highest Degree of Initiation.

"At which point," the old man had told me in conclusion. "All doors and gates will be opened for you, all devils and gods will bow before your throne, and all things will be subject unto you. You will be Limitless and undying. You will be Eternal."

Twelve years later, in the month of November, I was diligently working on the lessons I had been given for the receipt of the Sixteenth Initiation in the Order. Ascent had become my breath and my

blood, indistinguishable from myself as an individual. While I worked and played and even found membership and excellence in several religious groups and orders, the Ordo Ascensum Aetyrnalis was the one constant current sweeping me higher into the heavens and pulling me deeper into hell.

I had studied under at least fifteen different higher Initiates of the Order, and was then learning directly from the Grand Emissaries or the heads of the O.A.A. By this time, I had become proficient in the arts of evocation to both astral and physical manifestation, astral projection, remote viewing and several more transcendental practices. Evocation and projection, however, seemed to be my fortes, and were greatly encouraged by my mentors. As such, most every resource had been available to me, not excluding dozens of grimoires translated to and from various languages.

It was just before I was to receive the Sixteenth Degree of Initiation that my mentor called me to his home to be instructed in the method of the final lesson preceding the Initiation. I was told to sit in the dining room and I would be attended to shortly. Confused, yet always confident, I sat and waited.

Seconds after my mentor left my sight, I heard his front door open and shut again. Several muffled voices could be heard talking outside. I sat with fire under my seat until I could wait no longer.

I relaxed my mind and released my tension. My eyes fluttered closed, my consciousness wafting about, finally being directed towards the voices outside. I rose through the roof of the single story home and descended through the night air onto the four chatting men.

The moment their figures began to develop any sort of clarity in my mind, the front door swung open.,, as did my eyes.

The three strangers entered the house and marched directly to the dining room wherein I sat. My mentor, for some reason that then discomfited me, opted to remain outside.

Each man took a seat around the polished, wood table without speaking a word of salutation, Although I since have been admonished first by them and later by my superiors in the O.A.A. as to even hinting at the identities or physical characteristics of these three, I will say that they were well dressed, well groomed and clean cut men. Their manners were more professional than military, but were precise ail the same. Each also carried with him a large, sealed manila envelope.

I once again relaxed my body and let my mind sink into a deeper state of awareness, focusing in on the men that sat before me. I looked at each, attempting to view their individual auras, trying to discern their magickal or spiritual purpose in sitting mute at that table,

My vision of the physical world began to fade, and then reappeared with a fresh vibrancy. I cast my scrying gaze towards the man sitting to my right. The moment his aura came into view, the energy streaking from him and the definite glow around him manifesting, the man to my left interrupted this mystical reconnaissance with his opening statement.

"I am told that you are familiar with quite a few beings not of this plane. In fact, it seems that some of your associates wonder if you prefer *their* company to humans. You know your way in their world. You're considered somewhat of an adept in their ways."

Immediately, the man sitting opposite of me cut in.

"Don't think that we come to you, asking what we do, because you are an expert. We are here because you're one of the few that has the will, the intense desire, to travel the road that we're presenting to you. You have begged for this opportunity time and again. It'll be a while yet until you accept that you have. Still, your desire has called us here, to ask you before anyone else, to walk this path."

The three were silent once again. I, too, was silent. I was

excited and bewildered at once. I felt as if I had entered the latter half of an intriguing conversation, and had missed all the details.

The third, the man to my right, spoke up.

"You have studied the Goetia, the Black Raven, Grimoirium Verum, the Heptameron. Indeed, you have had access to the secret libraries of the O.A.A. You've read grimoires whose names I can't even pronounce, and have successfully performed every last operation in them. There is one that you haven't seen. Not many have. We have this grimoire here with us, and we haven't seen a single page or drawing."

"You see," the man to my left spoke again. "We were commissioned by the highest authorities in your Order to be guardians of this grimoire. We were to keep it safe until we were told when and where to deliver it. We have been told."

The man opposite of me jumped in,

"We each have a few pages of the full text, here." He tossed the manila envelope on the table in front of him. His two comrades followed the motion, I noticed that on each one in black marker was written the Roman numeral I, II and III. "We've been told to deliver them to you, tonight. With a message."

The third man took his place in the established speaking order.

"The text is in English, we were told, except for a few spells or conjurations. It is written in what can be called a skeleton cipher. The only information that is given in this grimoire is the absolute most vital information. That which was necessary to preserve through time."

"We don't know when it was written, or by whom," the first speaker said. "Your superiors didn't tell us that. We do know that they need you to piece together the rituals and incantations, to give them significance once again. You are to study the information, use the magick, and uncover its secrets. Your superiors need you to take the skeleton and put the flesh back on him."

"Your task is take what we give you here and to make it whole," the man to my right concluded. "Figure out how this magick works, how it's used, and to render a full manuscript on a complete system directly to them. We will never meet with you again. Don't look for us. Don't ask about us. We've done what we were asked to do, and this is where it ends."

The three men stood up at once. Each picked up the envelope in front of him and stacked them in front of me. In the same silence in which they appeared, they walked out of the room. The front door again opened, and then shut.

I left the house, the three envelopes tucked under my arm, still sealed.

Just as Crowley knew when he took the dictation of Aiwass in Egypt, and as Doctor John Dee knew when the angels began to speak to Edward Kelly, the moment I broke the seals of the envelopes and rejoined the three sections of cipher text, I knew without a single doubt that what was happening was greater than myself, greater than all of my previous studies, and even greater than the whole of the human race.

The Magick Squares

The Grimoire was basic and simple, its construct and application seeming to follow the traditional methods of evocation despite the deviances from traditional occult thought. The sigils were drawn like most others encountered in any other grimoire. The attributes which followed seemed to have little variance as well. In most every manner, the grimoire that was passed to me followed the basic principles of occultism. With this in mind, I stared blankly at the Squares that preceded each group of entities.

Most magick squares are complex mathematical algorithms which create a fundamental balance within the square. Those squares that contain letters can be translated into Hebrew and then into the numerical equivalent in that language. In so doing, the magus should be able to add the numbers of any line or column and produce the exact same sum as the rest.

Spiritually the squares are balanced as well. Each number is representative of an astrological alignment, thereby calling into favor the energies of that sphere. In combinations, the differing numbers coordinating with their astrological signifiers should complement each other and balance the square perfectly.

At first inspection of the Squares within the Grimoire, there seemed to be no method at all to the arrangement of the characters within each Square, the letters and placing having been chosen at random. I calculated the numerical value of each line and column, producing nothing but arbitrary numbers which had no relation at all.

I was desperate to discover some sort of pattern within the Squares before attempting to use them in any magickal or ritual operation. I referenced each letter and numerical equivalent to an astrological relation chart, which showed only that the Square was

entirely chaotic, Venus, Saturn, Mercury and Uranus all colliding into one line or row.

This discovery of the disarray of the Squares led me to the conclusion that either the Squares as given are useless and impotent, or that the text itself operates and is sustained outside of the realms of astrology and most modern metaphysical assumptions of astral reality. Whatever the case, the text could be deciphered only with an original approach and pure scientific method, leaving all occult religion behind.

Opening the Squares

The astrological and numerological value of magick squares is seen by most to be the magick itself. A common belief is that, once the square is drawn, the astral currents will flow to and from the square naturally, effecting change in the environment or in the operator. If a magician were in need of money, he might draw the first square of the 28th chapter of the Sacred Magick of Abramelin the Mage, put it in his pocket or wallet and begin job hunting.

As such, the magick of squares has nearly become a type of folk magick, in which there is no real ritual, but a simple action that in itself is thought to bring about change in a supernatural way. If a square is magickally balanced with coordinating astrological numbers or letters, it isn't difficult to see why this would work.

The Squares which I had to work with, however, contained no such balance, and even more, had no description of attributes or signifiers of any sort. They appeared to be more of a magickal preface to the evocation of the beings that followed. Viewing the Squares in this manner, I remembered the Enochian Tablet of Union.

The Tablet of Union is a composite of the four elements of fire, water, earth and air, representing the unity of these elements to

form a fifth element, that of Spirit. The Tablet becomes the concrete foundation upon which the remaining symbolism of the Working is built. On a larger scale, the Tablet of Union is representative of the Union between the microcosm and the macrocosm, thereby symbolizing the very object of magick: at-one-ment with the Divine.

Viewing the Squares in question in the same light as the Tablet of Union, it can be seen that rather than being a focal point for planetary or Sephirothic energies, each Square is a unification of several varying and differing forces which have collaborated to form a unique alliance. This was to be evidenced once I began ritual work with the Squares, and even more so in the evocation of several of the entities.

Although the Tablet of Union is said to possess a spiritual power of its own, it is nevertheless required to consecrate it through the ceremonial Opening by Watchtower, which brings to life that which is inanimate. Spending some time in meditation upon how to adapt the Cabbalistic methods to this strange grimoire, I was impressed with the idea that the Squares are somewhat at a midpoint between the Hindu Tattwas and the Enochian Tablets. The Squares, then, are Gateways into specific regions of the astral plane, and at the same time are the foundations of the magickal Operations which follow - specifically the evocation of the beings of each Kingdom.

I prepared a simple temple for my first real ritual from the grimoire. I had set up a desk facing south covered in a black cloth to form a makeshift altar and set two white candles to each side of it. A piece of parchment paper rested between the candles, the Square of the First Kingdom of the Flames drawn on it in thick, black ink. White tape was pressed to the carpet to lay out a large circle around the room, the cardinal designators also drawn with the tape.

I took my place on a wooden chair before the altar and rested my hands on my knees. Entering a Gnostic trance, I began the

opening visualizations and culmination of the energy needed to perform the ritual. The air gradually thickened and seemed to swirl with the unseen currents moving through it. My perception descended beneath the consciousness of the ordinary senses into an astral singularity of unhindered awareness.

My eyes opened and were led to the grimoire resting on my lap, the pages open to the Incantations. I recited the Banishing and Purification conjuration to cleanse the area of all unwanted forces. The magickal currents that were invoked by my initial meditation and those that had gathered with the recital of the Incantation swept out in an astral Shockwave from the altar, carrying in its wake the lingering psychic rubble loitering nearby. The room was quieter and my concentration peaked. The air buzzed with the magick of the Operation.

I returned my attention inwards, re-centering my being before reading the next incantation. Having decided to treat the Squares in a manner similar to Gateways of specific astral regions, I turned pages in the small book to the Opening of the Astral Gate.

The incantation for the Opening of the Astral Gate is written in three parts, The first part is in a language known neither to myself nor to any yet that has seen it. It seems to be an initial command for the Gate to open and the veils to be parted. Although I had read this before many times in silence, as I read it aloud it finally seemed to take on a shape and a substance that I had not imagined.

A column of astral light shot down from above, grounding itself in the altar, and more specifically, in the Square which sat thereon. I was instantly reminded of the common Middle Pillar ritual, in which a pillar of Divine Light moves through the magician, centering him in the magickal universe.

The column of light rushed with vibrations moving both upwards and downwards through the column, In my mind came the statement "The Upper shall be united with the Lower."

The second part of the incantation is a simple declaration of the magician's will, given in English. Expecting a magical reaction similar to that produced by the first part, I was confused at the lack of a lightning flash and clap of thunder as I recited the first few lines. It seemed to be more of a self-affirmation - a preparation for the lines that followed.

Continuing the English portion of the Opening of the Astral Gate, calling upon and commanding the Demons, Angels and Spirits, I knew that this was the potency of the body of the Incantation. As I called out to each of the three groups of entities, there was no doubt that they responded, crowding the sky above me and filling every empty space within the blackness of the night.

The conclusion of the incantation was again in the cacophonous alien tongue. Upon recital, the air that was buzzing with a billion electrified molecules was silenced so suddenly as to startle me as if someone had fired a gun next to my ear. The energy and viscous power that had filled the room drifted upwards and accumulated like a thin cloud that longed to rain.

Were the Astral Gate that accompanied the conjuration in the Grimoire drawn on the ground, it was at that exact moment that it would have taken form. I sensed an urgency in opening the Square, as if the mist above me were threatening to dissipate into nothingness.

My gaze left the astral mist above me and moved to the Square drawn on the parchment. My mind cleared itself of my surroundings, the Square being the only focus of my attention. I allowed my eyes to relax, my scrying vision opening into the Square. As it did, the lines and letters of the Square began to fade from my sight, only to return in a shimmering new dimension.

To my astonishment, a few letters randomly placed within the Square disappeared completely from my sight and reappeared seconds later. They were the same letters, but they were

dramatically changed. Instead of being drawn on the parchment, they hovered centimeters above it. The remainder of the letters followed queue, disappearing and reemerging into visibility in an entirely three dimensional view.

The whole of the Square was vibrantly alive and lingering above the altar. The ritual had not produced the minor result I had hoped for, but was manifesting a world that I had never imagined existed. None of the work I had done with Tattwas or astral gateways in the past could compare to this spectacle and the mad power rushing from it.

Looking above me where the mist once was, I beheld an image identical to the vibrant Square at the altar. The only variations were that the Square in the air was both larger and appeared to be more stable than the smaller one in front of me. Each edge of the projected Square must have measured at least five feet.

It took an enormous amount of will to look away from the Square that had become an opening beyond the fabric of known reality. Finally, I forced my eyes shut and regained control of my breathing.

Struggling to remain relaxed, I allowed my consciousness to gradually transfer itself to my astral body, until I moved my arm and its astral double rose instead. At that point I could no longer contain myself, and I rose from my meaty flesh towards the Square and into a land that few eyes have ever glimpsed.

Inhabitants of the Squares

Most grimoires to date contain the sigils and names of various entities that are readily classified by their planetary or elementary influences, a Sephirotic habitation or an era or culture to which they belong. This not only allows the Adept to discern precisely how to evoke each entity, but also gives him the knowledge needed to decide whether or not to evoke it in the first place.

The grimoire that was passed to me, however, was not so categorically simple. Reading through the descriptions of the entities inhabiting each of the Kingdoms, I quickly noted that only three classifications of beings were given: Demons, Angels and Spirits. The difficulty of effectively summoning and constraining these beings multiplied.

Another departure from traditional entity classification is a near complete lack of hierarchy within each Square or Kingdom with only one exception, the first entity listed in each Kingdom bore a title of "Grand" Angel, Demon or Spirit before its name. This could very well mean that each Kingdom is ruled as a totalitarian government, that one entity governing the remainder.

One large distraction from this theory of spiritual totalitarianism is obvious when the entity descriptions that follow the supposed "dictator" are read. Although a Grand Demon may be at the throne, within the same Kingdom are Spirits and even Angels that are in some way subordinate to that reigning entity.

In the minds of most orthodox, linear-thinking people, it is far easier to accept that an angel had somehow been given authority by a Godform or by the Divine Itself to compel Demons to do its bidding than to believe that a Demon had enslaved a holy Angel and had been forcing it to comply all along!

Unfortunately, such a belief is shattered when it is seen

that of the ten Squares given, only two are ruled by Grand Angels, one by a Grand Spirit and the remaining seven dominated by Grand Demons. The confusion is only compounded when one actually begins to evoke these Angels and realizes how willingly and graciously they go about the tasks given them.

With the skeleton text that I had to work from, I knew right away that the only way these questions could be answered is through interaction with these obscure entities themselves.

Regnum Spiritus

My first task in gaining an understanding of these beings and their world was to define their plane of existence. Normally, entities that can be evoked reside on the Astral Plane, a realm of energy and light. The Astral Plane exists just outside of the normal, physical sphere of sensation. Once trained in the solidification of the Astral Body of Light, the Adept can rise from his physical body and enter the Astral Plane, traveling it freely without the restrictions of space or physical laws of resistance.

The few diagrams and instructions given in the original skeleton cipher, however, refer not the Astral Plane but instead to a mysterious dwelling called Regnum Spiritus, the English translation of this simple Latin phrase being "Spirit Realm."

Traveling through the Gateway to Regnum Spiritus and also through the Squares of the Kingdoms, my primary observation was the similarity between the structure of this plane and the physical world. The Astral Plane being the final realm of the precipitation of any thing into physical manifestation, all things that will descend into physical reality appear to be a few steps ahead of the physical plane.

As an example of this, one may view the astral "double" of their hometown and see that a certain building is no longer on its

rightful property. Weeks later, the building may be torn down to make way for a city park.

The environment of Regnum Spiritus had no such connection that I was able to see. Many of the Kingdoms were structured much like one might expect of the physical plane, and are unchanged from the first time I entered it to the last.

Although many of these Kingdoms were dark and confusing, they lacked the chaos and uncertainty experienced when traveling the Astral Plane.

Contemplating these things, I realized that the Astral and physical planes are not separated by a stone wall or drawbridge, but most definitely overlap into one another. This is evidenced by periods of psychic abilities in untrained and uninitiated persons, or places that loudly ring of sinister energies and are "haunted" by specters and demonic beings. There are also places that seem to vibrate at a higher frequency than others, such areas being nexions to the Astral Plane. In actuality, this is part of the criteria for discovering the location to establish a magickal Temple or permanent ritualization place.

I concluded, then, that Regnum Spiritus was that realm of overlapping, the Spirit Realm that dwells closer to the earth's surface than even the Astral Plane. It is clear, when visiting these Kingdoms, that the Angels, Demons and Spirits have established a permanent residence in this area between the worlds. They had sanctified this crossroads between the upper and lower as their own magickal Temple.

D e m o n s

The most obvious trait shared by the Demons is a basic malicious drive. Although they will help the magician greatly, there

is always some harmful or adverse aspect in calling them. This is, of course, a banefui power whose force need not necessarily be directed towards the magician.

The full potency of Demonic influence is revealed when they are assigned a particularly sadistic task, such as inflicting an enemy with a life-long illness or stirring up a natural disaster in some unprepared part of the world. Taking all karmic superstition out of the equation, this type of black magick is the safest and most effective motive for the evocation of the Demons given in this tome. With Demons, destruction of some sort is guaranteed. When working with them, the magician must avoid the follies and assumptions that would bring this destruction upon himself rather than it being directed at some outside target.

A glance through the descriptions of the Demons and their abilities shows that, not all are harmful by intent. Nevertheless, they are still harmful by nature.

Iadon, a Demon within the Second Kingdom of Flames will graciously grant the Evocator all the wealth that he may desire. In fact, he will even give *more* than is asked for. Having summoned him and seen the remarkable results, I would love to evoke Iadon daily and reap the benefits. *Knowing* Iadon, however, doing such would be the last thing I'd advise. It is also said in his description that he will take back more than is had. This is usually overlooked or outright ignored by the magician while reading about Iadon and the wonderful things he can do, and so each shall find out exactly how much can be taken from him by requesting the aid of this Demon.

Iadon is just one example of a Demon that, by intent, does good for the magician, but by design will impart destruction. By this standard, a Demon who is said to cause certain devastation can be trusted far more than one that will bring joy and success.

The single exemption to this is the case of the Grand Demons ruling their separate Kingdoms. Their intents and their designs are

sinister without doubt. The great difference is that the malice of the Grand Demons extends so far and plummets so deep into outer darkness that all thought of the suffering or the joy of the magician are forgotten. The intent of the Grand Demon is to aid the magician in Ascent to the Highest degree of glory attainable. The nature or the "spirit" of these beings propels them to do so, for the benefit of the rain of fire that spills into the lower planes each time a mortal is raised to the state of a God.

While the demons crowd round the sufferer, hoping to catch a piece of his soul as it is torn to shreds, the Grand Demon will wait millennia to watch the whole of existence burn from the effect of one terrifying act. Despite the claims of the Buddhas and spiritualists, Ascent beyond the cosmic consciousness of Nirvana or Samadhi, deeper than the Ocean of Love and Mercy, is the most terrifying act imaginable. Sailing into a realm of Limitlessness, a state without boundaries or restrictions, breaking every chain and rending every veil brings brimstone destruction to all that is not composed of Eternal matter.

A n g e l s

It would be obtuse to state that the Angels within this grimoire are the complete antithesis of the Demons, entirely focused upon benevolence towards the magician and the human race as a whole. In actuality, the aim of the Angel is to bring about the greatest level of purity and righteousness as possible, both in the magician and his surroundings,

The Angels, although perfectly willing to assist the magician in gaining the things that may bring about success and happiness, have a greater goal in mind. Indeed, they have the Greatest goal in mind: the final absolution of the human being from this prison of pain into a state of Godly magnificence, To this end alone, they

cause miracles and magick to be made manifest, always laying a stone path to Ascent as they go.

At times, however, their gifts of Ascent and experiences that would lead the individual towards such are less than appreciated by some magicians. It is often necessary to keep in mind that the will of the Angel is aligned with the will of the Divine. The Angels know the minds of men, and will occasionally pay lip service to the magician's lower desires in order to lead him towards his True Path. In the matter of their resolve, there are some Angels that are more terrifying than the Grand Demons.

A good deal of the Angels that have been put forth in this text are expert in the powers of protection. They know the dangers with which one may be confronted as he travels through the unseen realms, and they have no doubt that the greatest service they can perform is to keep the magician safe from harm

Unlike the Demons, who usually appear in decadent and disgusting forms, the Angels almost always manifest themselves in a human form that is pleasant to look upon. Most are beautiful, muscular men who are able to appear both youthful and ancient at once.

A certain presence, a holy mantle, is carried by the Angels, a portion of which will linger with the magician as long as he desires it. This gift, in itself, is a powerful agent against the darkness that so often falls upon one who walks the path of Ascent.

Spirits

The term "spirit" is often used as a generic categorization for any incorporeal or disembodied intelligent being. Most often, it is used to identify the essence or the energetic embodiments of the dead, usually retaining a form and a memory similar to the one

which was held in life. It was difficult to see through this perception when dealing with Spirits as they are given in this grimoire.

While reading the descriptions and attributes of the Spirits, I found myself thinking of them as the deceased who, being earthbound, had developed special abilities in order to be of use here. That misconception was quickly done away with when the realization came that, like the Angels and Demons, the Spirits dwelled in their appointed Kingdoms and were anointed with the same powers and restrictions as were their co-inhabitants.

In summoning Tuel of the First Kingdom of the Flames, and in the conversation that ensued, I became aware of the fact that this being was older than mankind itself (as it has been established on this plane and planet). I found myself very confused as to the actual nature of Spirits after that first evocation of one. The discovery that two separate terms are used herein, one for "the dead" and another for "the Spirits" brought a sense of affirmation that the two are not interchangeable. The Spirits are not the wandering shadows of the dead, but are as unique and Providential as the Demons and Angels.

In comparing this grimoire to a few noteworthy others that have surfaced throughout the years, I was struck with the blatancy of the similarity between Spirits herein and the Planetary Intelligences given in the Key of Solomon the King as well as in the Arbatel of Magick. The difference between the two being that the Spirits operated within the realms of the Kingdoms to which they belonged whereas the Intelligences operated within a specific planetary or Sephirotic realm. All future workings with the Spirits have only complemented this conclusion.

The Spirits, therefore, are beings whose power is in their knowledge and their ability to impart such to the Operator. Where the Demons and Angels are powerful in their ability to bring about results and changes in a tangible manner, the Spirits are powerful in their ability to instruct the magician in his potency to do the

same. On rare occasions, a few of the Spirits are capable of using their knowledge of the mind and thoughts to distort the perceptions of others. The Spirits serve as guides, mentors and information gatherers.

C o o p e r a t i o n w i t h i n t h e K i n g d o m s

Only when I had successfully traveled through each Square and visited each Kingdom, interacting with the inhabitants therein, was I in a position to evaluate the hierarchy within them. Evoking the Angels, Demons and Spirits of those Kingdoms also aided me in discerning their relation to one another.

Trying to make sense of the oddity of the coexistence of these three conflicting types of beings, my mind kept ringing with a biblical passage:

“Every kingdom divided against itself will be ruined, and every city or household divided against itself will not stand. If Satan drives out Satan, he is divided against himself. How then can his kingdom stand?”

How *could* each of these kingdoms stand, being thoroughly divided, with one polar extreme or the other at the head? I studied the notes I had made in my Journal of Metaphysical Experimentations, coming to a few very different conclusions. Applying these conclusions to the context of practical interaction with these beings, I knew that I had made a gross error in my assumption that the Grand Demons or Grand Angels *ruled* the Kingdoms, with all other beings in a subservient status-

Could it be possible that the Angels, the Demons and the

Spirits, although very different in intent and basic nature, be so similar in design and Providential purpose that they could generate a level of cooperation great enough to coexist with one another?

As an example: in the Kingdom of the Shadows of the Dead, Targal is a Demon Prince that will bring an unrighteous deceased to manifestation before the magician. Saltanat is an Angel that will bring the form of the righteous dead in the same manner. Phaltorn, then, is a Spirit that teaches the secrets of binding the dead.

These three, although being of opposing alliance and serving different functions, are aligned in purpose enough that one complements the other, rather than conflicts.

We now are left with the mystery of the exact function of the Grand Demon, Angel or Spirit. At the onset, it was assumed that since "Grand" was a title held only by one entity within a Kingdom, there must be a hierarchy that is strictly held to, with this one creature at the head. Soon enough, however, it was found that no exact hierarchal structure existed within the Kingdoms, each entity acting as an independent organism, bound only by the innate virtues instilled at its creation by the Divine.

Working specifically with the Grand Demon of the Kingdom of the Blue Flame, I was impressed with the idea that rather than ruling over the entities of the Kingdom, his reign was over the essence of the Kingdom. Satagraal's description states, "... reigns over the currents of seership, self-projection and prophecy." I compared this to the description of Kaltemtal, Grand Demon of the Kingdom of the Night, which states "... reigns over the powers of darkness and oversees all that occurs in the shadows."

The Grand Demon, Grand Angel or Grand Spirit, therefore, has authority not over the entities which inhabit the Kingdom, but over the astral currents which dominate that Kingdom. I noticed in my visits to the Kingdoms that the Grand being was seldom in the company of the other entities of the Kingdom. He or she remained

alone to preside over the equilibrium of the energies of the Kingdom,
and to keep that balance in check.

Formulae

When I first received the Grimoire, it contained only one incantation for opening an Astral Gateway and a simple exorcism, and those were rather vague and generalized. I felt my countenance fall as I thumbed through the few remaining pages only to find that there were no more that the authors had hidden in some obscure place in the tome. I expected to find a myriad of conjurations and bindings, scourgings and banishings. I could not fathom why a text so rich in power and knowledge had left out what seemed to be the most important part of the whole.

After having some time to sulk, and some more to meditate and contemplate upon this setback, it became glaringly obvious that the exclusion was not meant as a setback, but rather as a catapult. The enigma was just that, a riddle to which only I could discover the answer. It was my task not only to decipher the words of the text, but also to discover the spirit of it.

The two incantations given contain a language completely alien to myself or to any of my associates, save for the three that had placed the text in my hands and immediately vanished. Searching various internet databases for a sample of the language exposed absolutely nothing as to its origin or translation. Much like the Enochian language discovered by Dr. Dee and Edward Kelly, this nameless tongue seemed to be quite automatic in causing a specific effect in the environment. In a way, the intonation of these passages brings about a shift in the atmosphere in accordance with the context of the incantation.

The non-English sections of the incantations possess a unique phonetic resonance that independently forces the voice into monotone. It is this droning chant that is required, and is almost involuntary,

in reciting the conjurations given in this mysterious language.

Few variations between the English portions in the Grimoire and traditional incantations are noticeable. However, those few are possibly vital and require specific examination.

Traditionally, an entity is evoked by virtue of the grace of its superior, all spirits being subject to a hierarchal chain of command. The conjuration will usually read, "Spirit N., in the name of (Superior Spirit), I call thee forth..." There are two basic reasons this is done: firstly, summoning a spirit by the name of its superior guarantees its obedience to the magician's command; and, second, using the name of the superior spirit in the conjuration is a manner of asking such spirit to release the particular subordinate for the time of the evocation.

Vibration of God Names is also used, either instead of the names of superior spirits or as a supplement. These names, usually in the Hebrew language, are thought to possess a universal power and authority in and of themselves. Thereby, the vibration of a specific God Name will cause the induction of the energetic atmosphere conducive to the appearance of the entity summoned, and will also prompt the entity into answering the call of the conjuration in the first place.

The incantations in this Grimoire, however, contain no such words of power or entity name-dropping. The only names given are those of the entity to be summoned and the evocator himself. This places the magician in a unique position. It places him in the same position implied by standing within the Circle, performing rites of centering and invocation of Divinity and by performing these Arts in the first place. Conducting a ritual in one's own name is blasphemy to the orthodox morality, as it places the individual in a position of Supreme authority over all astral beings, and, presumably, over creation itself.

The Gateway into Regnum Spiritus

The incantation that is given for opening a gateway into Regnum Spiritus can be considered the Call to open a generic Astral Gateway, meaning that it acts as a direct portal into the immediate astral realm without directing the instantaneous astral travel to one specific region of that plane.

In working with planetary or Sephirotic travel, the magician may draw on the ground or even project into the sky above, a physical or imaginary representation of a portal opening into the astral sphere in question. The gateway, then, serves to lead the astral traveler towards a specific area of the astral plane, as a type of focal point resonating the same energies as the objective point. This is also done with the Squares given in this Grimoire, as is discussed in that chapter. I was bewildered, however, at the thought that a magician would have the desire or even the need to open a specific gateway in order to enter what I thought to be a non-specific area of the astral plane.

These questions stayed with me, even while I drew the Gate in the dirt and opened the Grimoire to the incantation. Reading it aloud, all interrogation was washed from my mind as the entitles gathered and the gateway began to form.

Having left my body behind and stepped through the Astral Gate, I found myself in a vacuum, void of light and sound. Even thought dissipated more quickly than usual. I found myself in a place where only Will existed. Once this realization fell upon me, I began to understand the power of this tool I had been given.

The Astral Gate brings the Sorcerer to that black temple of nothingness, wherein only Will prevails, and prospers. In contrast to the rest of the astral plane, this is a place completely cut off from effect. It is what I have come to refer to as the Temple of Causality,

In this Temple, the magician may seed and cultivate his Will, with much reduced interference from external forces and influence. The galvanized Will, the astral formation of the Sorcerer's desire, can then be released from this prism into a receptive universe. This exact process will later be explained in some detail.

The Adept will realize, as I have with time, that this is a powerful two-edged sword. Without normal interference, the desires and thoughtforms generated will not mutate as they so often do. Thus, the end result will meet the magickal petition much more closely than is usually found. The obvious flipside of this coin is the mental and imaginative control possessed by or found lacking in the individual magician.

The one protection I've found in this regard is the rapid dissipation of random thought inside of the Temple of Causality. This forces the Sorcerer into the necessity of asserting raw Will inside of this black nexus, rather than simple visualization. Pushing the desire up through one's entire being, through every Chakra and past all psychological blockages, the goal begins to dance around and shimmer in its astral form.

Much like the final cementing of the Will in creating an egregore, the now embodied desire needs be sealed and pushed away from the magician, to take root in the world of creation. Some may do this with a ritual, a word, gesture, or a simple mental centering. Whatever the individual Sorcerer may prefer, it is only necessary that there is a definite sealing up of the Working and pushing it away from oneself entirely.

It is my thought, perhaps naively, that this Gate and Temple is a tool that is meant for use only by the spiritually Adept. Most cithers will be lost inside of the vacuum, confounded by their own charlatan nature, unable to find up from down, in from out. The meek may inherit the earth, but the remainder of creation belongs in the mighty.

Nevertheless, I give below the rituals that I have constructed and used successfully in performing the Operations within this Grimoire. I do this with hope that it may provide a subjective base upon which the practicing Adept may build his own Tower of Babel, using these words and Works to Ascend into the Highest Heavens, I have found with a certainty that these particular rituals do work to their ends, among the thousands that have not.

Opening the Gateway

Carve or draw on the ground the Gate, as given below, large enough that you may lie in the opening. The characters, letters in the same alien language as is found in the incantation, should be drawn precisely. The only light should be that radiated by the moon and stars.

Before reciting the incantation of the Gate, it is necessary to meditate and to solidify the Astral Body of Light. As the incantation is recited into the night sky, you should already be slipping from a state of physical conscious awareness into an astral consciousness.

The incantation is to be read in three parts. Having recited the first section in the unknown language, it is suggested that you allow yourself a moment to

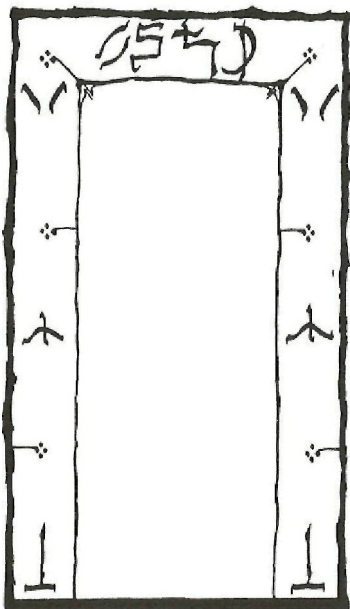

The Gateway

contemplate the changes in the atmosphere that it produces. At this point, allow your scrying vision to open, seeing the world around you with your spiritual eyes,

Continue to the middle portion, which will give the command to the three basic entities of the Grimoire and the very heavens themselves to serve you. This must be stated with full authority and confidence. For this reason, some may wish to perform, before reciting a word of the incantation, a simple empowering ritual such as the Hermetic Middle Pillar Rite or the even the Lesser Banishing Ritual of the Pentagram, if they are not able to naturally assume this form of Divine Authority.

Be silent for a moment, sensing and seeing the entities and forces aligning to make manifest your will. In reciting the final verses of the incantation, know that the ritual as a whole is being sealed up into being.

Lie down within the opening of the Gate that is drawn on the ground, looking into the air above you. Further open your astral vision, the obsidian night becoming your scrying mirror. Just as that black backed mirror does, the air will begin to fill with a white mist, culminating in one spot. This mist will begin to solidify and form itself into the Astral Gate through which you must travel.

Once the Gateway is seen clearly in the sky, transfer the remainder of your consciousness into your astral body of light. With your eyelids closed, see with your astral vision the spectral Gate above you. As you rise from your body, you will notice that the Gateway pulls you towards it. Do not resist the astral undertow, rather allow it to guide you straight into the mouth of the Gateway.

Having passed through the Gateway and found yourself in the black Temple of Causality, you will be able to project your Will into the vacuum, after which you will see it taking on shape before your eyes. This vision can be altered if it is not fully in line with your desire.

The spectral formation of your Will being made perfect, return then to your physical body and open your eyes. Some magicians may want to conduct a complete ritual enactment of the projection of their desires once they have rejoined with their bodies. Here, a simple declaration of your Will should be sufficient in sealing up the full manifestation of it.

The Incantation of the Gate

Rantka maa tazu metantu saspantu
Itz tertal kelt amta faltu
Eretisal kaltamu telka retzratu
Elkazu feltama partatu

I call out to the ends of existence
To the very last stars,
And I command:
This Gateway shall be flung open
The Demons shall let me pass
And shall destroy with fire
All things that would harm me.
The Angels shall clear for me a Path
That I will not be lost in this unknown land.
The Spirits shall come to guide me
And not to deceive me.
The heavens shall move in my behalf,
And this Gate shall open above me.
The Divine Flames devour me
And this Gateway now
Must obey its Lord.

Atz faltu pan talu
Saaks alu tem palta
Felt casu fem kela
Kelt amtu pez tasu.

The Summoning

I had become so accustomed to the highlighted portion of each grimoire being the conjuration and constraints that I was bewildered at the absence of one in the text at hand. Authors of these ancient books seem to take advantage of the full attention given to this section, offering beautiful orations to their Gods and issuing terrifying brimstone threats should the spirit disobey a single dot or tittle of the magician's command. In some cases several conjurations are given, just in case the spirit to be evoked does not appear. There was an overwhelming sense that something was missing from the Grimoire without these. It looked bare. It looked perfectly skeletal.

In order to make the Grimoire usable, some sort of oratory declaration was needed.

Regnum Spiritus rests very close to the physical plane, between the realm of substance and the realm of light. The entities that dwell in this region are therefore close by. This is evidenced by the speed at which they both manifest once summoned and complete their tasks once dismissed. They are always waiting to be called on and to stretch out the arm of their powers upon the face of the earth.

Several lengthy conjurations - often with the name of Christ inserted now and then - are nothing but vain repetitions when evoking from this Grimoire. Neither will the Evocator find much need for magickal threats or spiritual scourgings. However, there are a few basic guidelines that should be followed.

I

Once the area is prepared with all ritual items needed, as well as a notepad and pen with which information can be scribed, you should begin with any opening meditations and rituals that you have found to serve you well in magickal operations. The Square of the Kingdom

in which the desired entity is found needs be opened at this time.

II

You should either sit or stand holding the entity's sigil in your hand or resting in your lap, unless you will be charging it on an altar. Gazing at the sigil, allow your spiritual sight to awaken until the specific energy of the Summoned courses through it. Continue to skry into the sigil once this connection with the entity has been achieved, pulling the entity itself towards you. Some magicians will repeat the name of the entity until they sense its presence. This technique works well as a support for the inner will of the magician.

III

The above being performed properly, you should sense the presence of the Summoned. The air will thicken and will seem somewhat energized. It may be slightly more difficult to breath or your body will tingle in a very unusual way. In whatever manner this manifests itself to you, **YOU WILL KNOW** whether or not the entity has responded to the call. Here, most magicians, rather than beginning the spoken conjuration, would skry into the appearance of the Demon or would begin the constraints, as they assume that it is already present and doesn't need to be conjured. The conjuration, however, does not serve to bring the entity *near*, but instead brings the entity *forth*. Making a mental and magickal link with the entity through its sigil draws its awareness and its presence to the ritual Circle. The conjuration is the authoritative command from the Summoner for the Summoned to appear. The wording for the conjuration can be as simple or elaborate as each individual desires. What is necessary is that the conjuration begins with the title and name of the entity, gives a specific command using either the name

of the Grand Demon or Angel of the Kingdom or by the power of one's own "magickal" name. In the case of evoking a Grand Angel, Demon or Spirit, you will need to call him fully by the power of your own name alone, (example; Demon Prince Targal, I, Archaelus, call you into manifestation before me. In the name of the Grand Demon Terratur of the Kingdom of Shadows, I command you to rise up in a form beholdable to me.)

IV

If there is any one point in which an evocation is abandoned or is thought to have failed, it is directly after the conjuration. No genie appears nor does a ray of light descend from above on which an angel may slide down into the Triangle of Manifestation. The only reason for this is the fact that the Evocator has not prepared himself for the act of full evocation. Seeing and hearing and comprehending those things that are beyond the normal range of sensation requires training oneself to do so. For some, this may come easy, while others may struggle with it for years. But either way, it is a skill that is acquired and improved upon. The genie may be standing there, legs trailing off into smoke, or the angel might be slip-sliding down a ray of light, but if you haven't learned to see such things, it does you no good. Assuming that the weeks or years of training the finer senses into activity have been well spent, after the conjuration has been spoken, it needs to be backed up by pure magickal will. Usually a magician will be burning incense or may have even performed a blood sacrifice, the effect of either being to give the spirit a substance with which to build itself. This is not always necessary, as every magician discovers with experience, but it may be helpful. Using the incense or the blood as your focal point, or simply the area of the Triangle, will the entity to begin to manifest on this plane. Push into the Triangle as much of your own energy and prana as you are

able. As you are doing this, do not imagine what the entity will look like when he or she has manifested. Instead, let images and features spontaneously appear in your mind and before your eyes, until finally the Demon is standing before you, ready to communicate.

V

Looking upon the Summoned that has manifested before you, it is necessary to simply state your will that it shall answer truthfully all questions and obey faithfully all commands that are put to it, Although it is not entirely necessary, you may do this in the name of the Grand Demon or Angel of the Kingdom to which the Summoned is subject, or you may use your own name to do so. The object is only to establish a specific authority over the entity Summoned.

VI

Once all information has been gathered and commands have been made, thank the entity for attending and politely but firmly dismiss it. After the manifestation has dissolved, you should write a few notes about the experience as a whole.

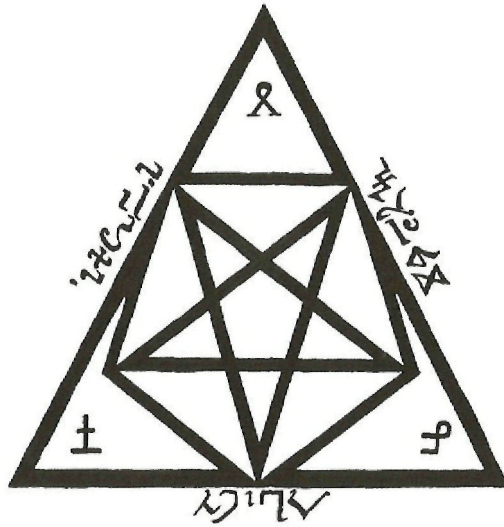

Seal of the Sorcerer

Above is the Seal of the Sorcerer, taken directly from the original Grimoire, to be worn or presented in some manner through the duration of whatever Working one may undertake from this Grimoire. It acts both as a protection and an empowering agent, calling upon all Demons, Angels and Spirits and the combined powers of the Squares. It may be drawn on sheepskin parchment, sealed in wax or clay or engraved in wood or metal. If metal is used, it should be silver or tin. If it is drawn on parchment, it must be drawn either in black ink or in the magician's own blood.

The main outline of the Seal is obviously triangular, a shape that has always represented in the occult the manifestation of non-physical entities or powers. In this case, the triangle signifies the powers of magick manifesting directly through the magician.

Contained within the Triangle is an inverted pentagram inside of a pentagon. The Baphometric symbol has always been the icon of all that is uncontrollable, for those forces within and without that are beyond the comprehension and constraint of mortals. In order to use these powers, therefore, it is necessary to ally oneself with the inverted light and to become a nexion for its power, rather than a harnesser of it.

Interestingly, the traditional Triangle of Manifestation used in most ritual systems has a two-fold purpose. It not only brings into manifestation that which is Summoned, but also imprisons the beings and powers within. Here, the inverted pentagram is imprisoned both within the outer triangle and then again inside of the pentagon, which has always been representative of protection and defense.

In each of the three corners of the equilateral triangle is a mysterious marking, none of them having any historical occult value at all. One possible explanation is that each one represents one of the three types of beings found in the Grimoire: Demons, Angels and Spirits. Drawing these symbols on separate pieces of parchment and skyring into them, I have concluded that the marking at the top of the triangle represents the Angels and also brings into being a spirit of unity. The marking at the lower right hand corner symbolizes the Demons and brings about a violent and fiery presence, while the marking in the lower left hand corner brings about a spiritual neutrality, representing the Spirits of the Grimoire.

As for the markings on the outer border of the triangle, there is not much I can contribute as to the translation of this, aside from the fact that it is the written form of the alien language found only scarcely within these pages, in the two incantations given. I can also urge the

magician to evoke the Spirits Fastos, Meton and Atron, and ask each one individually what the meaning of these inscriptions are. Each will answer differently, and in such each will provide a piece to the completion of the puzzle. In this endeavor alone, much knowledge will be gained.

Ex Regnum Spiritus in Manifestus

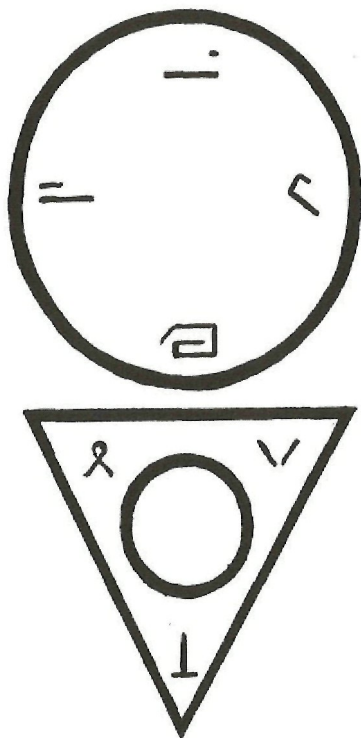

Each grimoire details specific devices needed for the successful evocation of the entities therein. As with the orations, the Circle, Triangle, robes, rings and ritual tools will be in agreement with the religious paradigm of the author or the era. The names of angels and Divine Names will usually be inscribed in the implements, as well as miniature crosses or sigils relating to the specific device.

The skeleton cipher seemed to be consistent in its ability to simultaneously include and exclude the most important information. On the last page preceding the names and sigils of the entities, the Circle and Triangle that are given above were drawn. No text accompanied the drawings,

leaving me again with plenty of room for discernment.

The Circle is the most basic device used in ritual, representing the continuum of all things, eternity, and the cycle of Brahma, Vishnu and Shiva, creation, preservation and destruction. It symbolizes completion, wholeness and unity. Metaphysically, the Circle forms a barrier, protecting that which is inside from that which is out. At the same time, it is a chamber holding inside whatever concentrated energies have been risen or invoked. From the moment the ritual begins until all beings and forces are banished, the Circle should be drawn and its lines should not be crossed.

Usually, the ritualist will inscribe within the Circle at the cardinal points the names of the corresponding Angels of the Watchtowers, or with the Enochian or Hebrew words of power for that sector. As seen in the above drawing, there is but one symbol or marking in each of these places. Once again using each of these independently, it is obvious that each is representative of an element. The top marking, in the northern position, is water. To the east is air, the south is fire and the west is earth. Many systems do not agree completely with one another on the placements of these elements; the manuscript originally placing them where they are, and metaphysical experimentation validating their magickal resonance, I have left them as they were intended.

The Triangle is by far the most fascinating part of the drawing. Traditionally, entities are called from the east, the same cardinal point in which rituals are begun. Here, however, the Triangle of Manifestation is given in the southern position. Having discovered that the south relates to fire, I can only conjure two possible reasons for positioning the Triangle in this direction: 1 - the powers and entities of this Grimoire are of the "Flames" and therefore are of a fiery nature, literally; 2 - a majority of the beings to be Summoned are Demons, and even the Angels and Spirits seem to be a bit more fierce and passionate than found in other grimoires.

The only other explanation for this odd placement is the possibility that the magick of this Grimoire is entirely unique and independent from any other magickal system or lodge, to the extent that it is contained by its own laws and precepts and is an entire system unto itself.

Within the Triangle is a smaller Circle, in which the Summoned actually manifests. This presents a threefold protection and constraint; the Circle, Triangle and second Circle.

At each of the three points of the Triangle is a marking or symbol. It becomes apparent in the evocation itself that these act as wards of the Triangle, magickal implements in their own right, inscribed here for the specific act of evocation.

The marking at the top left of the Triangle has already been established as symbolic of the Angels, and is drawn here as a protection, a Holy Guardian Angel called forth to oversee the ritual and protect the ritualist, in a sense. Standing within the Circle in ritual, this actually appears at the magician's right hand, exactly where one would expect the Angels to be seated.

The marking at the top right of the Triangle seems to imply imprisonment or binding. In scrying into this one alone, the magician may begin to feel cramped or claustrophobic. After experiencing this, it is not a difficult feat to imagine this symbol having a similar effect on an entity manifested within the Triangle in the context of a full ritual. This symbol, therefore, serves to keep the entity restrained to the confines of the Triangle, and more specifically the confines of the Circle within the Triangle.

The final marking in the bottom corner of the Triangle is an obscure one, even after scrying into it. It seems to act as a manifestation base for the materialization of the entity. In a way, it supports the occult mechanics of the whole act of evocation itself, stabilizing all of the devices and maintaining the balance of the magickal currents.

Purification and Vanishing

The following exorcism is the only other incantation found in the pages of the cipher. It is to be used preceding and following each Working performed from these pages. At the oration of it, the immediate area will be swept of all energies and entities not conducive to the Working at hand. It may also be employed in times of spiritual maelstrom, to silence the shrieking astral winds.

**Ashu malku ta dat arkata
Zastus sechj altamu partu
Tretempal krej ta jelta
Vashalla regent met venturus
Ta sastrus estus melta
Kelta, kelta, kelta hine.**

M	S	R	T	A
E	H	M	A	K
U	A	E	B	L
S	A	A	K	S
S	T	E	M	L

First Kingdom of Flames

Above me in the air was the Square of the First Kingdom of Flames. Each line and letter burned in its manifestation. I looked deep into my soul in search of some sort of fear, something that would keep me grounded and anchored to this world. Instead, I found the Square opening, widening, forming a gateway in to the terrible, unknown Regnum Spiritus.

My eyes still focused on the Square above me, I entered a new state of Being, clearing my mind and stilling my emotions. I filled myself with Light until it was throbbing inside of me. In the manner in which I was trained, I transferred the whole of my consciousness to this Astral Body of Light, and I rose.

The letters of the Square distorted and eventually dissolved against the strain of my ethereal body pressing through the invisible

material of the Square into the realms beyond. Several voices, all male, whispered around me as the impassible barrier was breached. Although I strained, I could not make out particular words, nor could I sense any emotion behind the rustling of voices.

Darkness surrounded me, as if it were night without any stars or moon. In the distance of the black desert burned fires as large as buildings, from which issued the sound of soft singing. There were dozens of these fires lit, all in different directions and distances from where I stood at the opening of the portal.

Like a beetle or a moth, I was drawn to one of these flames, and found myself instantly soaring towards it. Figures danced in circles around the heap of burning substance, but it was clear that they were not human. Most were faceless black specters that immediately were wary of my intrusion. Some hissed at me in words that I did not understand. Others were silent... an even more menacing gesture.

One of the silhouette beings entered the giant inferno, uniting with it in the way that liquid mercury will when separated, The rest did this, one by one, the fire growing larger with each, until I found myself alone at the base of the burning mountain. I gazed into the roaring flames, contemplating the nature of these black beings, these embodiments of cold, dark flame. The longer my eyes remained transfixed, the more possessed I became with the whole of the thing.

The voices I had heard upon first entering this Kingdom returned, now proceeding from the fire, as if the flames themselves were speaking to me. The force that had first pulled me to this particular pillar of fire now pulled harder, amplified by the intelligent beings that inhabited it.

I drew closer to the heat of the fire. I couldn't resist the tow that dragged me into it. I didn't want to resist. I was entirely obsessed wand intolerably possess by the essence of the flame itself. I drew closer to it until the heat devoured me. Even closer until the flames consumed me. I was drawn into the burning heap until I, too, was burning.

I had found the ecstasy of the First Kingdom of the Flames. I returned to the First Kingdom of the Flames several time before actually evoking any of its inhabitants, probing deeper into the landscapes. Some of the fires burning in the distance were the ceremonial pyres of the black figures; other were entire cities made of pearl and gold that blazed a fierce light into the surrounding darkness.

As I opened each Square within the Grimoire, entire worlds were uncovered, as were endless mysteries and truths never before conceived by the minds of men. One could travel those lands for lifetimes and only behold a small portion of their secrets.

Herein is given only a glimpse. The remainder is for the individual explorer to discover, uncover and Ascend.

Martal

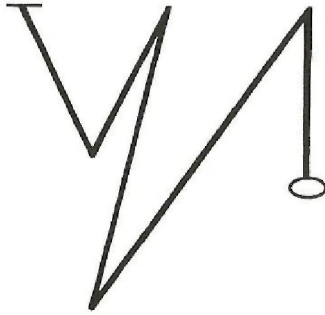

Grand Demon of the First Kingdom of Flames

Martal - Grand Demon of the First Kingdom of Flames. Despite his title of Grand Demon, Martal appears as an elder man with long grey hair and a white beard. He possesses the distinct appearance of one with great knowledge, experience and wisdom. In contrast to his apparent age, his body is in amazing condition, his muscles well toned and his general fitness peaked. His eyes are very deep and piercing, looking through the Operator's heart like a patriarch to a child. He comes adorned in a red cloak and clothing, in a fashion after Renaissance noblemen.

In Pathworking within this Grimoire, Martal is the first being you will encounter. As such, he reigns as the Grand Demon of the First Kingdom of Flames, and dispenses knowledge concerning the secrets of initiation. He will cause the whole of the universe to align to the Operator's path of Ascent and can clear the way for further initiations with ease.

Listen carefully while speaking with this Grand Demon. His words are few, but each one carries with it waves of omniscience.

Eshmak

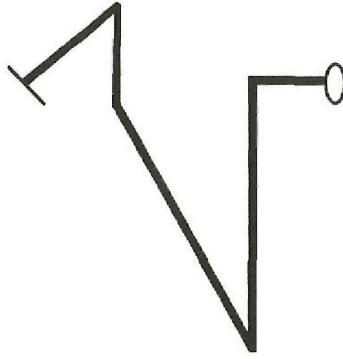

Demon having power over assertion of Will

Eshmak - Demon having power over assertion of Will. Eshmak first manifests as a thick, black mist before the Evocator, who then can either communicate directly with this or can command the demon to take on a human form. The latter will cause the mist to swirl, gradually culminating as a thing, gaunt man with sunken-in features and little hair remaining. Eshmak speaks quietly, as if some enemy might overhear the conversation, and has a slight hiss in his words.

The demon Eshmak can help the Sorcerer gain control and dominion over any person's thoughts and perception, placing images and prompting in a person's mind or distorting that which is already there. He is bound, however, to the mind, as he had no power over a person's emotions.

Tuel

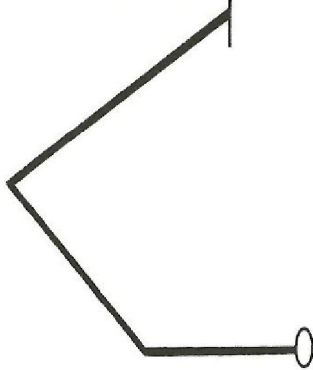

**Spirit that has overseen the
race of man since the
beginning here**

Tuel - Spirit that has overseen the race of man since the beginning here. Tuel appears in the form of a tall, lean man. He is well dressed, wearing blue and white colors. His hair is light brown and is well trimmed. Nearly always, Tuel brings with him a pleasant smile and a gracious amount of patience, although the gleams in his eyes are more visions of the fires of war than the flames of love.

Tuel knows the history of all civilizations that have been set up on this earth, and is always delighted to share this knowledge with the magician. Although this information is intriguing and a great deal can be learned from these conversations, Tuel's true power is in his understanding of the rise and fall of every nation and empire. Such knowledge, once grasped, can be easily applied to any person's life and affairs. Utilizing what is learned from this marvelous Spirit, the Operator can affectively build an empire around himself which, fortified by the atavistic vantage given by Tuel, will stand where even the greatest have crumbled.

Samassk

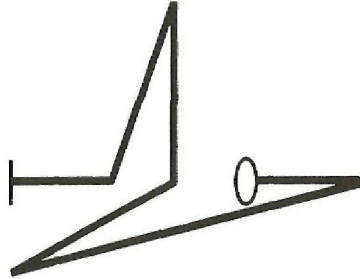

Angel of Protection and Defense

Samassk - Angel of Protection and defense. Samassk appears as a man barely 25 years of age. Beneath the white and yellow robes in which he is covered can be seen a magnificently built body. His face is kind; at times he could well be described as charming. Samassk rarely speak, allowing the Evocator to talk while he listens politely. It is his nature to only give comment when he is specifically asked to do so.

Samassk protects the body of one that is soaring through the heavens in more subtle bodies. He will also protect the spirit of the one in flight, sending sentinel spirits to accompany the magician should it be needed.

If ever there is cause for defense or need for protection, there is no better comrade than Samassk, He is an unflinching friend to the one that calls him, and an unrestrained enemy to any that would desire to harm the Operator.

K	A	T	O	K	A	R
A	L	L	C	R	A	A
T	S	P	S	F	H	U
L	O	L	T	S	A	E
A	L	L	T	A	A	E
E	A	N	M	R	G	O
A	N	T	M	L	T	B

The Kingdom of Night

The Square of the Kingdom of Night opened into a large, square room made of pure gold. Quite contrary to what I had imagined this Kingdom to look like, the gold walls, floor and ceiling made the place extremely bright. The room itself was about fifteen feet cubed, and was completely bare.

After my eyes had adjusted to the glare reflecting off of every golden wall, I could make out pictographs covering every inch of them, as well as the floor and ceiling. This gave an impression of an Egyptian pyramid chamber. There were quite a few birds engraved into the gold, and pictures of natural scenery, such as trees, mountains and lakes. Although I cannot read the hieroglyphs or pictographs of Egypt or any other such civilization, I had the distinct impression that the whole concept being portrayed by them in this room was of the original act of creation.

The wall to my left had an opening for a doorway built in it, but no door or hinges attached. I walked through it to find myself in a room that was identical in construct as the previous one, yet extremely different in the pictorial depictions on the walls. This room seemed to give the details of a very large and violent war, being fought with crude weapons yet still causing destruction on a massive scale.

I had the unfounded thought that this war preceded the rise of the Babylonian Empire.

There were two doorways in this room, one leading to the first room and the one on the opposite wall leading elsewhere. Taking the second doorway, I entered yet another identical room, this time the images seeming to show modern warfare and global destruction. No longer were ancient hieroglyphs used, but instead the walls were covered with elaborate drawings and full sections of wall covered in the same mysterious script as is seen in this Grimoire.

I traveled from room to room, the secrets of time and its devastating wake put before me in horrifying detail.

Reaching the seventh room in the circuit, I found three beings standing inside of it, waiting for me to enter. One was an older man that I later learned to be Althalln. The other two were young boys that served as familiars to that Spirit, who never spoke but kept watch over their master.

Entering more rooms with this Spirit, he was able to help me understand what I was seeing, past, present and future, and assured me when I left the Kingdom that he would remain there, ready to teach the Traveler that which he had taught me.

Kaltemtal

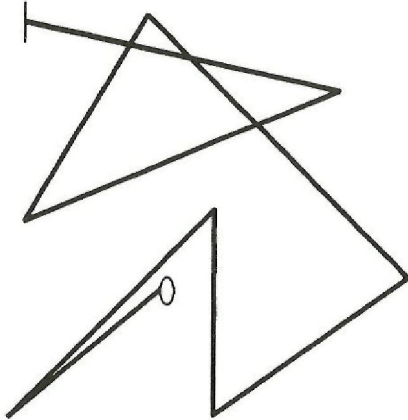

Grand Demon of the Kingdom of Night

Kaltemtal - Grand Demon of the Kingdom of Night, Kaltemtal comes cloaked entirely in black, as if he were an Arabian marauder, and stands at least six feet tall. All that can be clearly seen are his hands and his eyes. His hands are strong and solid, usually balled into fists as he speaks, adding an extreme punctuation to his words. Azure eyes pierce through the black hood and face mask. His gravelly voice is constantly kept low and discreet.

Kaltemtal reigns over the powers of darkness and oversees all that occurs in the shadows. He is the keeper of the secrets of Domination, and will initiate the Summoner in the powers of such.

Raskutor



Demon Prince having power over the essence of man

Raskutor - Demon Prince having power over the essence of man.

Raskutor appears as a strong man, possessing a very noble air. He is garbed in fine, red clothing topped with a black cape. His ebony hair hangs to his shoulders and he keeps a gentleman's mustache and goatee.

Raskutor will deliver any person into the magician's hands for any purpose, being adept at deception and trickery. He is a very violent, unstable demon, yet is extremely hypnotic. It is advised to avoid gazing directly into his eyes, lest he gain full sway over the Operator's senses and discernment.

Opfaal

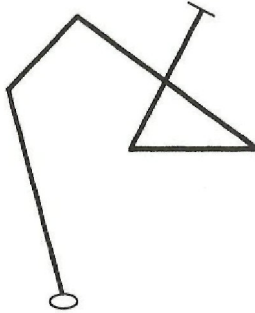

Angel of Deliverance

Opfaal - Angel of Deliverance. Opfaal comes as a tall man wearing pure white robes. His shoulders are broad and his upper body is padded in muscle, though his strength does not make him the least bit intimidating. There is nothing about this Angel that could warrant the slightest amount of discomfort in his presence. His eyes are sky blue and seem to dance with laughter and joy.

Opfaal will deliver the magician from any type of magickal curse or spiritual bondage. He can free the mind from any fears or plagues, and can release the individual from addictions. It is in his power to lift any enchantment that may be working on any person and to restore one's spiritual health.

Although Opfaal's assistance is astounding at any time, his abilities are at their highest on the new and the full moon.

Althalln

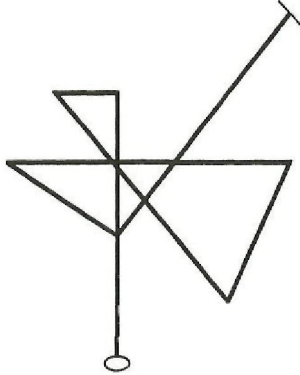

An ancient and learned Spirit

Althalln - An ancient and learned spirit. Althalln appears as an elderly man with stringy, white hair and wrinkled skin, yet not at all feeble. He wears a dingy, blue cloak that seems to always be covered in some strange powder or dust.

This noble Spirit has gained complete familiarity with the shadows and the darkness. Althalln will guide the Operator through the living night in which he may need to walk, that it will not consume him. He can banish an army of Shadows in one word, and can gather them together in another.

Althalln is respected by all spirits, and demands the same of the Evocator.

Centamot

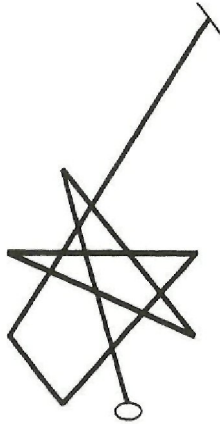

Demon of Despair

Centamot - Demon of Despair. Centamot has no shape that can be compared to human. It could be said that he shows himself as a mass of black oil that collects and coagulates into a form with which the magician may converse. At other times it may seem that there is a shadow darker than the night that stands embodied within the Triangle.

Centamot is a wicked demon that thrusts men into darkness, despair and evil, Under his influence, the most righteous man will commit every sin imaginable, and will forsake his own soul to outer darkness. Centamot takes great pleasure in this sadistic work.

Sraagbel

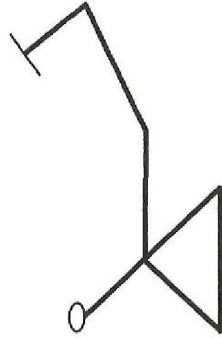

Spirit of hallucination

Sraagbel - Spirit of hallucination. Sraagbel comes often as a young boy, and at other times as a man, but can take on any image that he sees fit. His manifestation will alter to meet either the desires or more often the fears of the Summoner,

This Spirit visits the enemies of the Sorcerer in visions or dreams, plaguing them with hellish fear. He knows the secret thought of the enemy, and will use this knowledge to his advantage. Often, he will play upon devices or deeds in the enemy's past, whispering that one thing repeatedly into his ear.

Sraagbel's greatest power, however, lies in his ability to show men the awful truth of things. In this, friends are shown to be deceivers, subordinates are known to be conspirators and even the victim will despise himself for the truths that can no longer be hidden.

F	M	T	E
T	A	O	S
O	T	N	A
R	S	O	N

The Three Wise Men

As I crossed through the Gateway that had been opened with the Square, I found myself inside a foyer of a large temple. The dwelling was cylindrical, and apparently empty of all beings, The only distraction from the high, white walls and the bare floors were three doors placed evenly around the circumference of the foyer. The doors were identical in size and design, save for their colors and the symbol inscribed on each.

Upon the blue door was drawn the sigil of Atron, Upon the red door was inscribed the sigil of Fastos, and on the white door was seen the sigil of Meton.

I first entered the red door, belonging to Fastos. Inside the adjoining room was nothing but wooden bookcases running from the floor to the ceiling. The room itself was as large as the foyer to which it connected, and the ceiling was just as high.

The bookcases were crammed with large books, most of which appeared to be hand bound in leather jackets. I scanned the books, searching for one to take from the shelf, but saw that there were no titles written on the covers.

I chose one book at random and opened it, finding gold leaf pages rather than paper. The script in the book was in the unknown language that I had seen and heard far too often for comfort while working with this Grimoire. As I looked over the letters, however, I found myself comprehending the words and the context written. The particular book that I had chosen seemed to be a guide in the descent into the Underworld, I estimated that it contained over a few thousand gold leaf pages.

Picking up a few other books, and then again in each of the three rooms, I found the same result: volumes of specific information, written on gold leaves in the alien script that I now could mysteriously understand.

Fastos

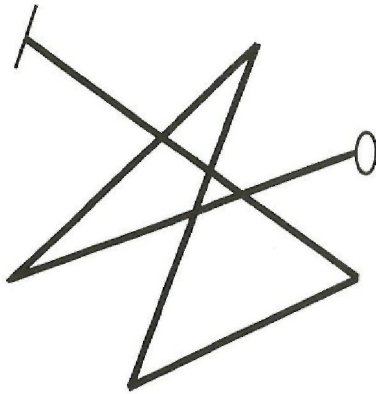

Spirit that knows the true tongue of the Demons

Fastos - Spirit that knows the true tongue of the Demons, and the secrets of demonic communion. Having close association with Demons, he knows their hidden attributes, powers and weaknesses.

Fastos appears as a spectral figure, semitransparent, and often will partially fade in and out of manifestation.

Meton

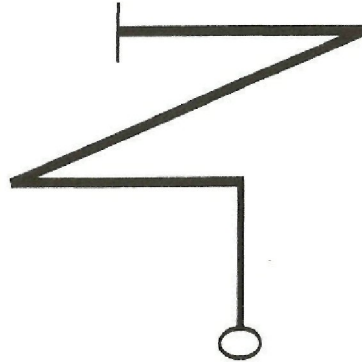

Spirit that knows the pure tongue of Angels

Meton - Spirit that knows the pure tongue of Angels, and the secrets of angelic communion. He can answer all questions of the origins of the Angels, of their purpose, their powers and their hindrances.

Meton appears as an older man whose hair has just begun to whiten with age. He is pleasant to speak with and to behold, although there is an obvious sadness in his eyes. He will never speak of this if asked.

A t r o n

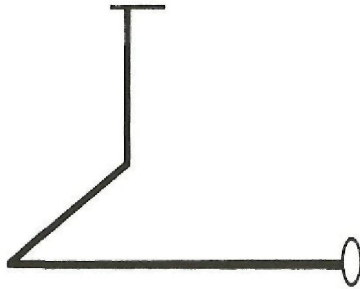

S p i r i t t h a t k n o w s w e l l t h e
w a y s o f t h e S p i r i t s
a n d o f t h e d e a d

Atron - Spirit that knows well the ways of the Spirits and of the dead, He teaches the manner by which both may be constrained promptly, yet graciously. For this, Atron is disliked among the Spirits.

The Spirit Atton appears as a man near death, barely a hair left on his head or a tooth in his mouth. Around his body rests a watery, blue aura, and with him always comes a spiritual heaviness in the air. It is advised to spend as little time with Atron as possible, as his presence is quite literally sickening.

P	N	A	I	H	I	C	T	A
L	O	O	L	H	K	N	A	P
D	A	R	O	T	D	A	I	R
R	E	I	O	E	E	O	O	L
S	E	A	D	N	L	A	E	B
A	O	M	A	K	A	R	A	O
U	D	A	S	K	L	I	T	I
L	D	R	G	A	G	R	L	T
N	R	O	I	N	O	A	D	L

Second Kingdom of Flame

Beyond the borders of the Square of the Second Kingdom of the Flames was found an entire landscape identical to one that could be found on our physical earth. The soft, cool ground was covered in fine blades of grass and several rolling mounds. A single village sat in the distance, built up around a citadel.

In the same moment that I had seen the town, I found myself in the center of it, standing at the foot of large, stone steps leading to

the monstrous metal door on the castle, Dozens of beautiful people, finely dressed and well groomed, loitered on the steps, discussing random subjects in the language which has thus far confounded me.

I moved up the steps towards the giant door, and those speaking fell silent, Moving closer, the door itself swung open, revealing a large room with a high ceiling and gorgeous tilework on the floors. The room was empty, save for a throne too grand for any mortal ruler. Upon it was seated an even more grand ruler: Pendraion.

Pendralion

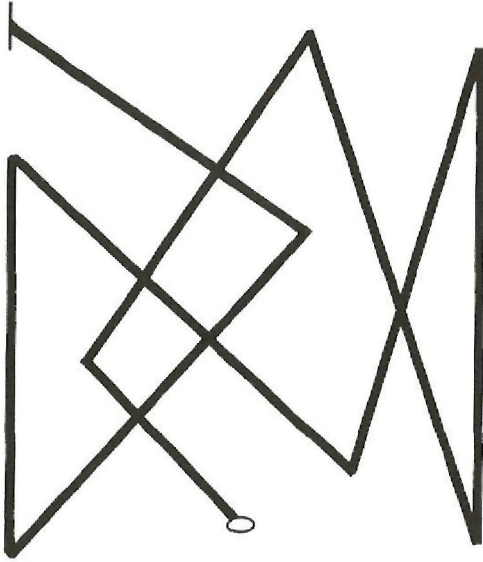

Grand Spirit reigning over the second Kingdom of Flames

Pendralion - Grand Spirit reigning over the second Kingdom of Flames. When summoned, Pendralion comes seated on a large throne. He possesses a younger appearance than most astral dignitaries, yet such does not distract from the air of nobility that he carries.

Pendralion has complete knowledge and influence over the currents of material power, wealth and stately influence. His instruction, if followed, can alter the course of empires and set men up as kings.

Iadon



Demon having power over all forms of wealth and abundance

Iadon - Demon having power over all forms of wealth and abundance. Iadon comes quickly to the call of the adept. His face is usually covered in shadows which seem to move with him. The only of his features clearly visible are his eyes, which are rarely focused on one object at a time, and the glint of his jagged teeth when he speaks.

Iadon seems gracious, as he is very quick to aid the magician in acquiring wealth. Beware, however, for although the demon always gives more than is needed, he will take back more than is had.

It is not wise to hold company with Iadon for longer time than is needed, as he holds strong sway with those with whom he is familiar.

Ladilok

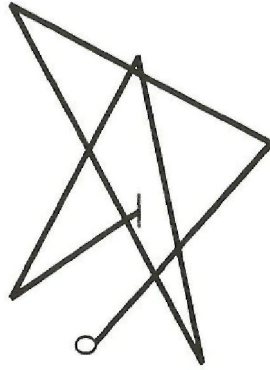

Enslaving Demoneſſ

Ladilok - Enslaving Demoness. Ladilok most usually appears before the magician dressed in a red and black gown which seems to be perpetually swept in the astral winds. When not speaking, her bloody lips nearly always remain in a seductive simper. Becoming trapped by her gaze and allowing the emotions to rise at her presence is almost common when dealing with Ladilok. The magician must guard himself against himself when doing so.

Ladilok views mortal women as slaves and as playthings for spirits and men both. It is therefore her pleasure to enslave any woman on the behalf of the Sorcerer, to do with as he commands. She will ensnare the thoughts and deepest feelings of any woman desired with incredible ease.

Acheron

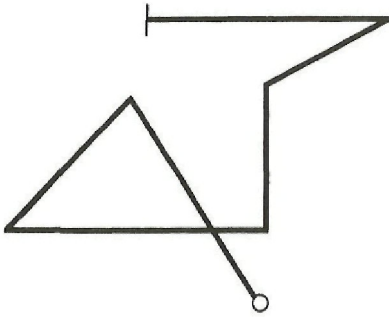

Angel of Influence

Acheron - Angel of Influence. Acheron is the only angel found in this Grimoire with wings. These wings stretch out from his back with a giant span so great that it is difficult to see the edges. There is a kindness in his appearance, bested only by a look of pure authority.

Acheron is a mighty angel who possesses the ability to sway men in the Magician's benefit. Although this is a potent facility, it seems shallow next to the absolute sense of peace that Acheron carries with him. A portion of this Divine peace is left with the Summoner after the Angel has departed, the likes of which dispel all darkness, fear and trepidation.

Lukorst

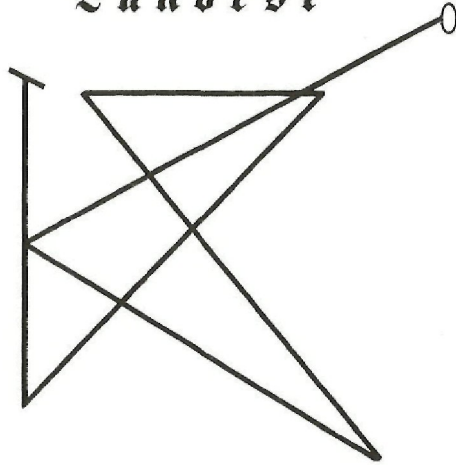

**Beneficial Angel able to
bring any amount of gold,
silver and pearls**

Lukorst - Beneficial Angel able to bring any amount of gold, silver and pearls as may be needed. Lukorst appears as a tall man encompassed in golden light. This light is the force which attracts all beneficial things to both him and to those that he leaves his essence with.

Lukorst will respond to the request of the magician with haste, and will supply him with as much wealth as is needed. It is advised to only ask for what is necessary, however, as this Angel holds no respect for greed.

Parion

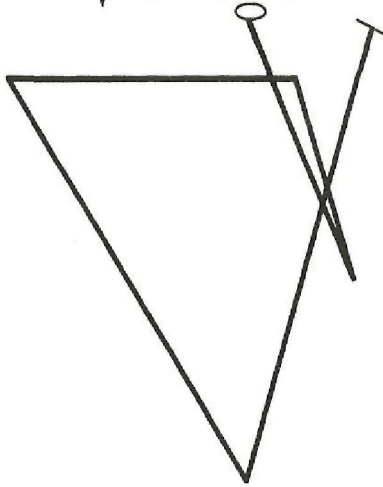

Noble Demon of recognition

Parion - Noble Demon of recognition. Parion manifests as a beautiful demon, younger in appearance than most astral dignities. A certain fire burns in his eyes, a passion for all that can be. He comes robed in violet silk embroidered with gold. His speech is very direct, yet very proper.

Parion distributes all forms of title and recognition. He can easily raise a beggar to a king. He is master at showing the Sorcerer what he could become if only he played by a new set of rules.

Greed and material exaltation are the fundamental principles by which Parion operates, and in such realms is he the greatest ally.

Deggall

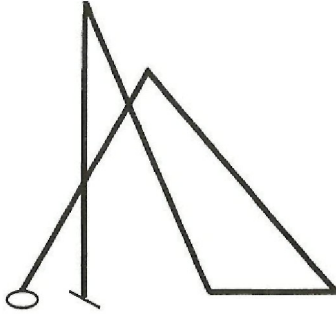

Glorious Angel of Light

Deggall - Glorious Angel of Light. Deggall comes enveloped in Divine Light which shines so brightly that it is difficult, if not completely impossible, to make out any of the Angel's features. Deggall's voice seems to issue not from his mouth, but from his mantel of light, beaming forth into the ears of the Magician.

Deggall will surround the Magician in a similar light, which will serve to show to manifest one's greatest qualities and exemplify the Godliness within. Such is the influence of this covering of light that all who see the magician within its grace will inquire of his name and will seek after his presence.

Abartala

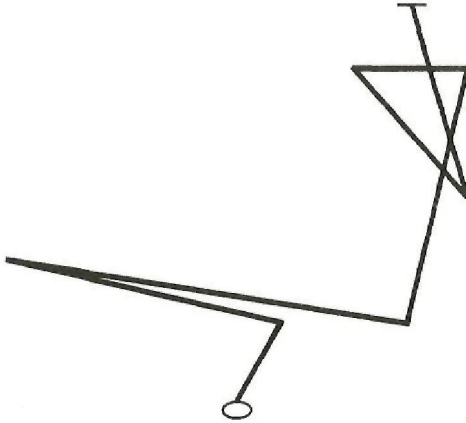

Guiding Spirit

Abartala - Guiding Spirit. Abartala appears as a tall, thin black man nearly 30 years in age. The Spirit is clothed in dusty, brown robes. He has little hair left on his head, and his eyes do not seem to focus well.

Abartala is a great Spirit that will guide the Magician on any path he may wish to pursue. His advice is comforting, and his wisdom is priceless. There is little in the way of religion and the occult that he has not aided in the formation of.

Hekaltor

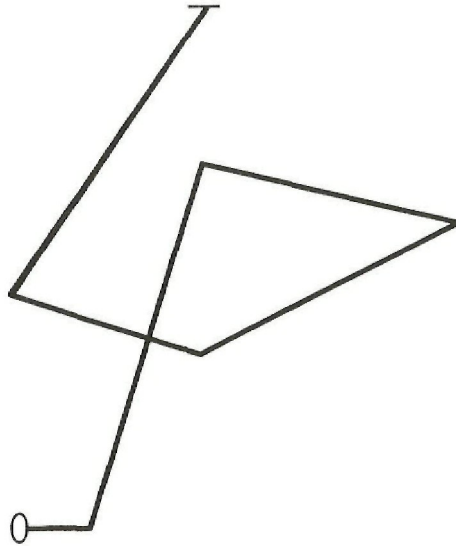

M i s c h i e v o u s D e m o n

Hekaltor - A mischievous Demon. Hekaltor does not manifest in any solid form, but rather comes to the call of the Magician as a culminating darkness, an oily black shapeless mass. His voice may first take the form of electrostatic popping sounds, eventually causing the formation of words.

Hekaltor causes disputes and turmoil among people, nations, churches and even planes of existence. He can effortlessly bring chaos to any situation or any life.

Disodioria

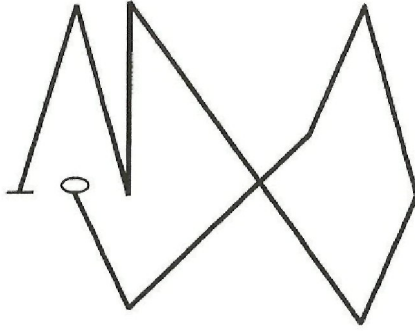

Mad Demoness

Disodioria - Mad Demoness. Disodioria's appearance may shift between a beautiful, young, innocent virgin and an old crone. Often, in speaking, she will mumble and rant on subjects of absolutely no relation, as if she were her own victim.

Disodioria whispers madness into the ears of men, confusing their thoughts and leading them into insanity. A great ally and an awful foe.

Maelta

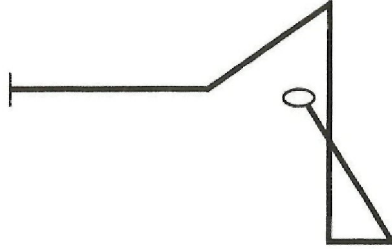

**A great spirit that reveals the
secrets and keys of gaining command,
authority and nobility**

Maelta - A great Spirit that may first appear as a falcon or as any type of tropical bird, but immediately assumes the shape of a man dressed in simple clothing. He says very little concerning this odd initial manifestation. Maelta shows himself as a tall, healthy man with long, brown hair and blue eyes.

Maelta reveals the secrets and keys of gaining command, authority and nobility. This Spirit can give to the Magician exercises and practices that will allow him greater control over the perception of others. His advice is simple, but is empowering without end.

S	O	G	P	A	T
S	R	A	A	F	O
O	L	A	A	I	L
L	T	R	T	H	R
S	A	T	T	N	A
S	T	R	A	A	A

Kingdom of the Blue Flame

Passing through the Square of the Kingdom of the Blue Flame, I found myself in a black region, in a space without stars or planets but just as vast as the timeless galaxies. The only anomaly in eight was a giant indigo nebula, swirling and churning within itself. This indigo anomaly did not appear to be made of gasses, hut rather of the deep blue light itself.

My consciousness was drawn into the nebula the moment it entered my sight, and inside I began to drown as if I were victim to an endless undertow. Regaining my sense of magickal authority, I

noted that to my vision it seemed that the swarming indigo light was collapsing on me, my Body of Light becoming an astral singularity.

Faces began to emerge from the blue light that assailed me, and just as quickly faded. Entire gossamer landscapes appeared, then dissolved as if they were merely hallucinations. In the madness I knew that this indigo nebula was the Kingdom of the Blue Flame.

Satagraal

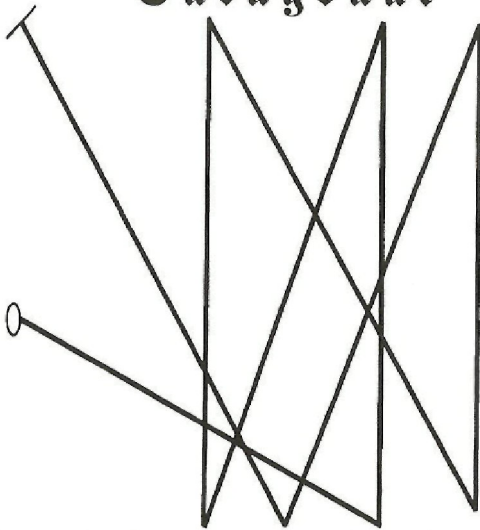

**Grand Demon reigning over
the currents of seership,
self-projection and prophecy**

Satagraal - Grand Demon reigning over the currents of seership, self-projection and prophecy.

Satagraal appears as a muscular man seated on an obsidian throne. His long straight hair is black as well, and his eyes are B piercing green. He usually speaks only a few words in the duration of his manifestation, and those few are chilling.

A thick, blue aura surrounds Satagraal, increasing with each second he is seated on this plane. His eyes are constantly glancing at the air above, desecrating the flight of things that even the most adept Seer cannot behold.

It is advised to not be hasty or reckless in calling forth this Grand Demon, as the force of his summoning tears the veil between the realms without restraint.

Paltator

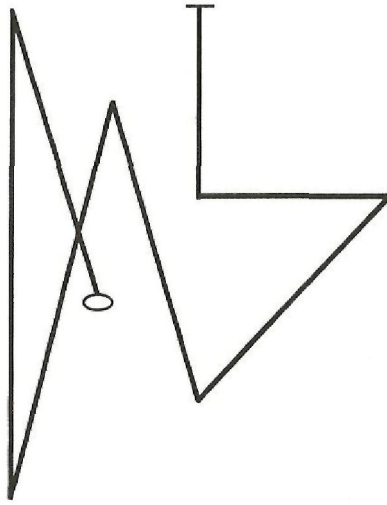

Angel of the gifts of Vision

Paltator - Angel of the gifts of Vision. Paltator is androgynous, and possess both an extremely masculine and extremely feminine appearance at once. This Angel usually comes dressed in violet robes and is soft-spoken and kind.

The most marked sign of Paltator's coming, however, is the rapid awakening of the Higher senses as the Angel first begins to materialize before the evocator.

Paltator blesses with the gift of Sight and will teach the magician how to fully access and utilize this gift.

S a s t a n

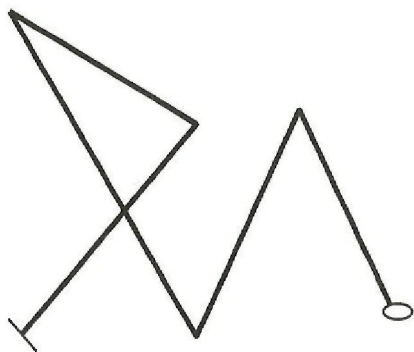

Spirit that will guide the magician in developing his Higher faculties

Sastan - Spirit that will guide the magician in developing his Higher faculties. Sastan first appears in the form of a large salamander, which the Sorcerer must promptly command to take on a human shape. This being done, Sastan will assume the appearance of a large man with darkly tanned skin and long white hair.

Sastan will guide the magician in developing and perfecting clairvoyance, clairaudience and many other forms of Seership. He also claims to know the secrets of shapeshifting, and will share these with one who is ready.

Fortiar

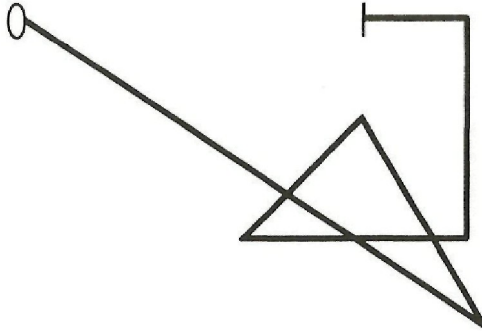

Binding Demon

Fortiar - Binding Demon. Fortiar appears as a bald man robed in coarse, brown material. The magician may find it disconcerting to look directly at the Demon's face, as his eyes have no iris or pupil, but are entirely white. He will notice the aversion, however, and will be offended by it,

Fortiar has the power to bind or even destroy the gifts of another, the permanence of which depending solely on the victim's own magickal skill.

Thalos

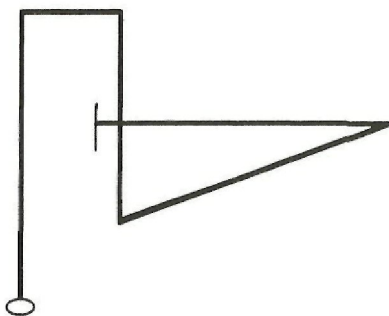

Spirit that teaches the art of Projection

Thalos - Spirit that teaches the art of Projection. Thalos does not take a solid manifestation, but will appear instead as a culmination of wind, or as an airy spirit who is seen one second and invisible the next. Even in this manner, it is still undeniable that the Spirit is present when he is. Thalos' voice issues from the windy space before the magician as a current of air which surrounds the Sorcerer with the words that are spoken.

Thalos will guide in the methods of True Self-Projection, teaching his student how to rise from his body and enter the realms of finer substance. Mastery over the Astral Body of Light is possible when working with Thalos.

Once he is certain that the basic procedures of Self-Projection are mastered, Thalos will begin to give the magician the secret keys to the portals of the Astral Realm.

T	A	G	T	A	A	S
A	P	T	L	R	A	M
R	R	A	O	N	O	A
A	A	A	T	N	L	M
R	L	H	T	U	E	T
R	T	H	E	T	S	O
E	T	O	R	R	T	P

Kingdom of the Shadows

The opening of the Square of the Kingdom of the Shadows brought me to what appeared to be a hideous swamp, enormous dead trees strung in moss, blocking out most light. Moving through the marsh, I noticed thousands of pairs of eyes peering out from the man sized grasses and disappearing just as they were spotted.

The whole of the environment became darker as I moved towards the center of it. Soon there was little to see at all through the black veil of spiritual night that had fallen, the density of the air suffocating my every pore as I struggled to find my way.

Led only by an inexorable magnetic pull, I continued the journey to find myself moving through an underground passage. The sensation that I was sliding through this passage as if it were a hydrotube struck me. The deep chamber at the end of the passage was clearly lit, yet as I descended into it I saw no torches or light source whatsoever.

The light of the chamber affected an exact circumference in the center of the area, the same thick darkness that characterized this region becoming a continuous tapestry along the dirt walls, behind which thousands of beings were lying in wait.

On the crusted and cracked ground was drawn the Square of the Kingdom of Shadows, around which was drawn the six sigils of the great Spirits therein. I stood in the middle of the Square, looking down at it and at the same time noticing the figures hiding in the shadows moving closer to the Square, and to me. I wondered whether I was evoking them or if they were evoking me.

Terratur

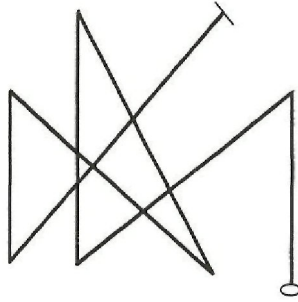

Grand Demon ruling over the Kingdom of the Shadows of the Dead

Terratur - Grand Demon ruling over the Kingdom of the Shadows of the Dead. Terratur is a black and terrible Lord, a demonic juggernaut standing as tall as two or three men and appearing to have the strength and muscle of at least ten strong warriors. Although he carries with him no weapons, the Grand Demon possesses the air of a warlord nonetheless. His head is shaven and throbs with veins, his massive jaw constantly clenched and his narrow eyes never wandering away from his object.

Terratur rules over the Kingdom of the Dead, as the keeper of Souls and the warden of Hell. When he speaks, it is not his voice that is heard, but the voices of the Dead speaking in unison, clamoring at once from his mouth.

Targal

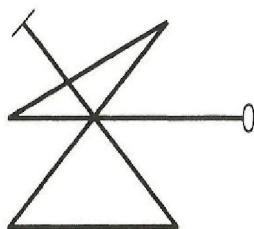

Demon Prince of the Dead

Targal - Demon Prince of the Dead. Targal manifests as a young, cunning man, full of guile and contest. He is always dressed in burnished black leather from neck to feet, matching the black hair that falls lightly to his shoulders. The magician may find brief annoyance at the smirk that is always on Targal's face.

The Demon Prince will carry any wicked soul from his burning pit of pain into the Triangle before the Sorcerer. He will also bind the shadows of the dead to obedience and truthfulness.

Saltanat

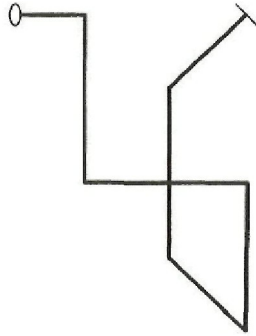

Angel of the righteous Dead

Saltanat - Angel of the righteous Dead, Saltanat appears as a weary man, his once white garments covered in dust and ashes. Similar to the other Angels given in this Grimoire, Saltanat is surrounded by a radiant aura despite his weathered appearance. His voice is also in contrast with his demeanor, carrying a cheery and almost sing-song melody as he speaks.

Saltanat will send for any person having died a good man to stand before the magician. Although the Angel can constrain them to be obedient and truthful, the Dead may not be able to answer all questions of existence after the flesh.

Phaltorn

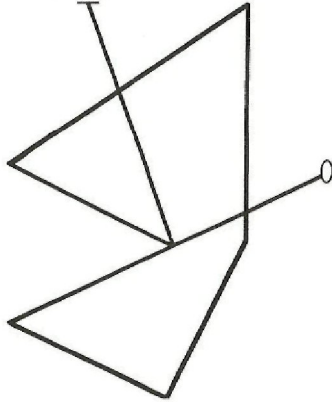

Spirit who knows the secrets of the dead

Phaltorn - Spirit who knows the secrets of the dead. Phaltorn appears as a semitransparent specter holding in his right hand a leather-bound book covered in grey dust and in his left hand a long, iron chain. When he speaks, Phaltorn's voice seems to be coming from far away, distorted and muffled by the distance, although his materialized image stands only inches away.

Phaltorn teaches the secrets of rousing the Dead to visible appearance and conversing with them through various means. He also teaches the methods of binding them so their information is true and accurate and their obedience is ensured.

Heptomaltor

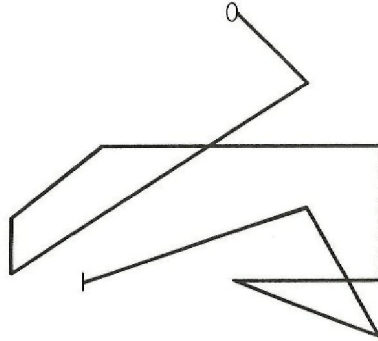

Demon of Torture

Heptomaltor - Demon of Torture. Heptomaltor is beloved of the Grand Demon Terratur. The ugliness of this Demon is so overwhelming that the magician will find it difficult to look at him during the Summoning. Heptomaltor appears to be something other than beast, yet his manifestation is most certainly not human. His voice is hoarse, and is obviously forced in order to communicate in a manner understood by human ears.

Heptomaltor will torture any soul that disobeys the Sorcerer with fire and with scorpions. It is said that the Demon can also do the same to the enemies of the Sorcerer, although there must be good cause to call him from his place in the underworld to do so.

M e s t o r a t

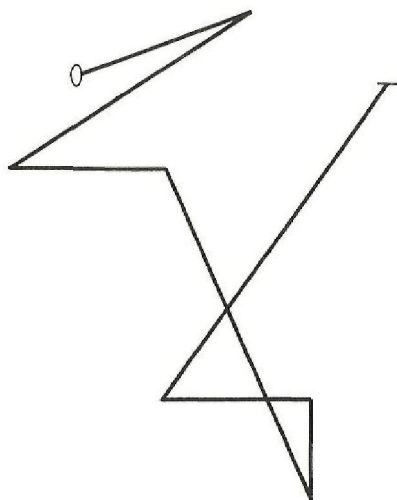

Protecting Angel

Mestorat - Protecting Angel. Mestorat manifests as a muscular man with well groomed hair and fierce eyes. The Angel appears with no covering on his torso and a white sarong covering the lower half of his body.

Mestorat will protect the magician from the shadows of the Dead, should they rise from their graves without having been Summoned and seek to devour the living. If the Angel is seen in this task, he will be carrying a large, golden sword and will be surrounded in a brilliant light, chasing the Dead into the caverns of Hell.

A	S	U	o
K	L	R	I
E	S	T	P
T	U	L	R

Kingdom of the Red Flame

Traveling through the Square, I was taken to a lofty place above the clouds, Indeed, the entire Kingdom of the Red Flame rested on a landscape of thick, white clouds.

There were no structures or habitations in sight, hut my vision scanned the vast airy place, I could see a multitude congregating not far away from where I stood. My sight having fixed upon them, my flight took their direction.

Coming upon the congregation, I saw that it consisted mainly of angelic beings whose beauty and luminescence defies description. They were young and lithe beings, fair skin and hair being the majority. They crowded round a central figure, and as I

drew closer I could hear them singing and praising, filled with the purest love and exuding the same.

Soon, I could see the object of their adoration seated upon a great pearl throne. In the moment I saw her, her beauty filled my being, penetrated into the most hidden parts of myself. For that moment, I was obsessed, forsaking the scientific objectivity that had brought me to this place.

Her beauty was terrifying, overwhelming the discipline that I had struggled my entire life to gain. I fled back through the Square into my warm body and the safety of the confined and mundane senses.

Lotir

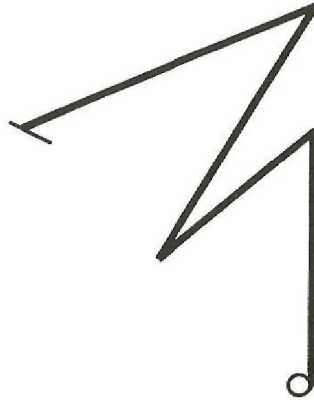

Grand Angel ruling over the Kingdom of the Red Flame

Lotir - Grand Angel ruling over the Kingdom of the Red Flame. Lotir appears seated on a large white throne made of pearl. With her come several angels who worship her on her throne and sing praises of her majesty and grace. Lotir is possessed of porcelain skin that is in constant glow. Her blond hair is always in perfect waves, dancing on shoulders and her back. Her eyes are dreamy, as if she always is seeing in her mind the face of the one she loves, and on her red lips is a smile that is only seen on a young girl who has just received her first kiss from her true love.

Lotir rules over love and all matters of the heart. She is concerned, however, only with that which is True Love, never playing fool's advocate in lustful and gluttonous emotions. If love is True, Lotir can rearrange the stars to bring it to fruition.

S a s p u

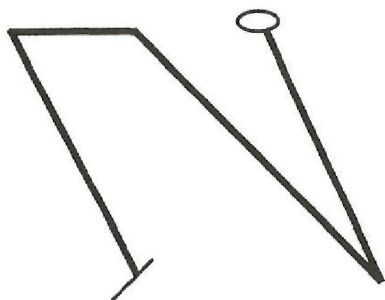

Angel of love and friendship

Saspu - Angel of love and friendship. Saspu manifests as a beautiful male angel with a strong chest and broad shoulders. Yet, there is a definite kindness and even femininity that is apparent in him, as well as a boyishness that contrasts harshly against his muscular appearance. His hair is short and in tight curls, and his lips are red and soft. Saspu's voice is always gentle, and he is always genuinely concerned with whatever situation is brought before him.

Saspu will bring love and friendship into the life of the magician, or to another whom the magician shall name. This Angel will gracefully refuse to perform any type of mind control magick, but will give alternative methods to achieve an even better result.

Kret

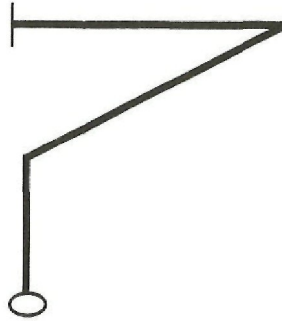

Beguiling Demon

Kret - Beguiling demon. Kret manifests as a man with reptilian features. His grey skin at times is scaled and at others is slick and oily. His eyes have no iris, but only large, black pupils. His speech is quiet, and is often enunciated with a hiss. While speaking, Kret usually stares directly into the eyes of the Evocator. Maintaining a "staring competition" with this demon is likely to make the Sorcerer disoriented, dizzy and may even cause him to fall into a slight trance, giving the Demon Kret power over the evocation.

Kret will beguile any desired woman and deliver her to the Sorcerer with remarkable speed. The duration of the enchantment upon her, however, is short, and necessitates quickly taking advantage of the magickal result. The Demon can be constrained to divulge his secrets to the Summoner, so that he may use its power at any time.

Tul

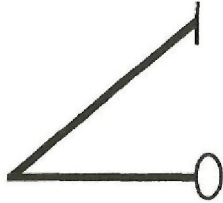

**Spirit knowledgeable
in the matters of love**

Tul - Spirit knowledgeable in the matters of love.

Tul appears as a tall man, older in years yet still very full of life and love. He wears a giant smile and always carries with him a beaming star in his eyes.

Tul will reveal to the magician that summons him the secrets and the knowledge of love and Soul Mates. He can see the heart's truth, and knows what must be done to win the love of another, or to find love within oneself.

A	A	N	T	M
K	H	O	T	R
M	E	G	O	R
D	K	A	S	E
N	L	A	K	A

The Third Kingdom of Night

As the Square of the Third Kingdom of Night opened and took form above me, I heard shrieking, as of women being tortured and children being slaughtered. The noise swiftly moved from the Astral Plane and pierced my physical ears. My hands moved to cover my ears, to block out the horrific sound, only to have me find that the shrieking could not be muted or even softened. The longer the noise was in the air, it took on an increasingly melodic sound, literally sweeping me from my physical body towards the opposite black side of the Square above me.

I found myself in blackness, in a molten essence of evil. This was not an abyss like the others [had found in my travels, but was very crowded, stuffy with smells and sounds. The visible darkness in the place was more than an absence of light. It seemed to be just the opposite: a compressed darkness which made it difficult to move, impossible to see and which catalyzed all sounds and smells in the place.

The shrieking that assailed me earlier was now isolated into several different voices, each one wailing in their own corners of darkness. I struggled to move towards the nearest of these voices, but found myself only able to direct my movement in one area. It was as if there were a path that I could not see, but which bound my travel all the same.

Going down this magnetic path, the wailing began to subside, the unembodied voices being held captive only near the opening of the Square. In the distance were small lights flickering in the darkness like tiny fires burning in the sky. I sped my travel, coming closer to these lights, soon to find that they indeed were fires, but were certainly not floating in the air.

I beheld on this black landscape nine cylindrical towers, each one surrounded at the base with a ring of fire and spewing flames from the top like torches. In each tower I could see one silhouetted figure, donning a hooded robe, his hands stretched out to his sides, looking down at the Kingdom with an air of an accursed reign.

I was instantly impressed with the thought that these were called the Towers of Night and Flame. The moment the words entered my mind, I found myself back in my physical body, trembling from the residue of the coldness of the Third Kingdom of Night.

Adakamon

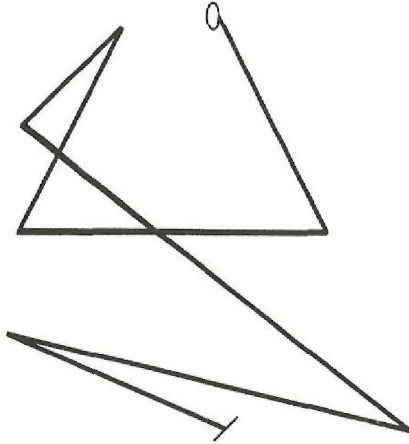

Grand Demon of the Third Kingdom of Night

Adakamon - Grand Demon of the Third Kingdom of Night. Adakamon manifests as a muscular man wearing a leather battle dress studded with polished steel. His long, shiny black hair is tied behind his head. His face is hard, his jaw bulging with his teeth clenched. His constant glare seems to melt all he surveys. When the Grand Demon speaks, there is heard a rumbling behind him, every word punctuated with the slight thunder of his Kingdom.

Adakamon is the Lord of all murder, war, rape and bloodshed. He is the Grand Demon of misery and suffering.

Keltar

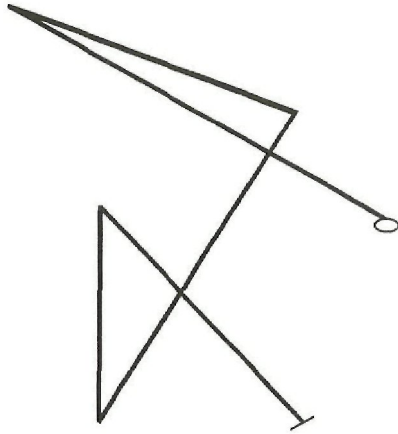

Demon of Slaughter

Keltar - Demon of Slaughter. Keltar's manifestation shifts throughout the period of an evocation, the most dramatic shift being when he is given his command. The demon always takes the form best suited to the specific work he will be engaged in. At times, his image will be entirely unintelligible to human logic and understanding. When working with this demon, anticipate all dreadful things.

Keltar slays men by diverse methods and in painful ways. His preference, however, is to slay by fire.

Methsan

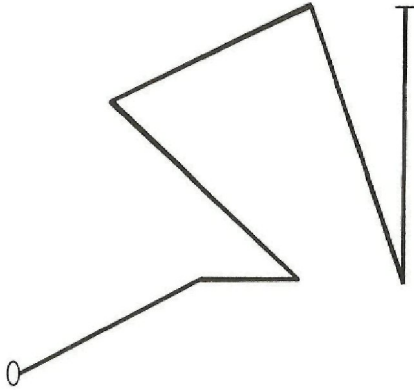

Demon of Poison

Methsan - Demon of Poison. Methsan appears in a manner like unto a man that has been dead for weeks. His skin is sagged and torn away in parts, his innards are beginning to spill out from the cavities in his stomach and he reeks of general decay, the most noxious odor one has ever smelled.

Methsan is the Demon that poisons the blood and the air of men, and causes their organs to decay within them. His victims are assured the slowest and most painful death.

Gorka

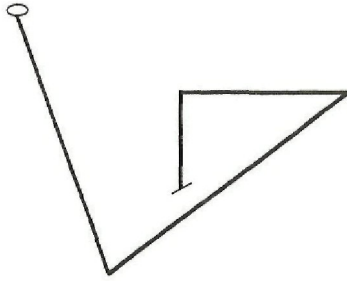

Demon Lord of all despair and betrayal

Gorka - Demon Lord of all despair and betrayal. Gorka appears in the same image as the figures seen within the Towers of Night and Flame. He wears a robe, the hood of which obstructs the magician from viewing his face. His voice is remarkably clear, and carries an authoritative ring.

Gorka slays men by their own hands, or by the hands of other men. He will rouse friends to slay friends, mothers to slay their children, husbands to slay their wives.

R	A	A	F	N	S	A	I
O	A	A	D	O	Z	M	E
N	T	A	S		M	A	A
C	S	S	N	A	T	L	N
A	L	T	O	K	O	R	T
O	E	A	K	S	O	L	N
H	A	A	I	E	K	A	P
I	L	L	K	A	H	T	A

Ninth Kingdom of the Flames

A grey cobblestone path lay within the Ninth Kingdom of the Flames, winding over grassy mounds on its way to the central habitation of the Kingdom. Fruit trees were carefully planted here and there along the path, decorated with more beautiful and sweet smelling fruit than this physical world would ever know. It was daylight in this Kingdom of the Astral Plane, although I could see no sun. The air was silent, the noises of the birds and insects that I had expected

to accompany such a midsummer paradise not invading the peacefulness that comprised this place.

The winding path led to an enormous white temple whose spire seemed to rise high above the clouds, reaching even to the throne of God. I moved down the path only to instantly find myself walking through the grand pearl doors of the temple.

The white, solid walls rose nearly 30 feet high in the entry, meeting a vaulted ceiling. The floor was white as well, seeming to be made of polished granite throughout.

As I stared around the room, amazed, a man stepped into the room. Where from he came, I had no idea, as the only door I could see was the entrance. The moment he spoke, the white walls instantly became blue. I was told that this was the First Temple of Varai, where men come to be trained in the ways of godhood. He continued to elaborate, but it was all too much for me to intellectually cope with. He said that I would not be allowed into a great deal of the Temple just yet, but that with time I would be handed keys and would eventually be able to open every door in the place.

The man, who I later recognized from my evocations as being the Angel Haask, advised me to return to my body and begin Summoning forth the beings of this Kingdom, and to come again through the Square with a greater understanding of the Temple of Varai.

Enkidorat

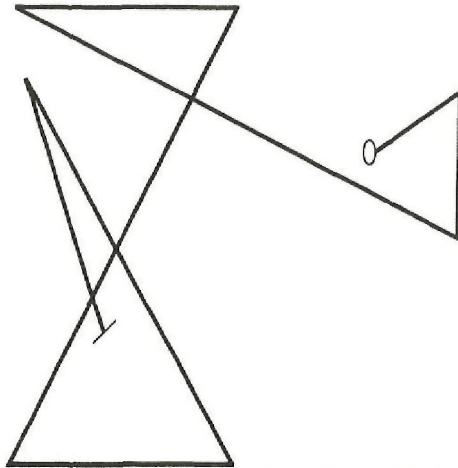

Grand Angel of the Ninth Kingdom of the Flames

Enkidorat - Grand Angel of the Ninth Kingdom of the Flames.

As Enkidorat beings to materializes before the evoking magician, an unseen angelic choir can be heard singing praises of Ascent from all directions.

Enkidorat appears as a glorious angel, robed in a material which seems to have been woven from a piece of the Divine itself. His blond hair flows past his shoulders and his indigo eyes reflect the secrets of Eternity.

When he speaks, the Grand Angel's voice does not issue from his mouth, but rather comes from above like a rolling thunder that is soft yet still causes all of creation to tremble.

Enkidorat is the Grand Angel of Ascent. He is the balancer of Karma and instructor of Gods. He possess all of the knowledge of the tools of Godhood, but will only endow the magician with that which he is prepared to receive.

Pontimas

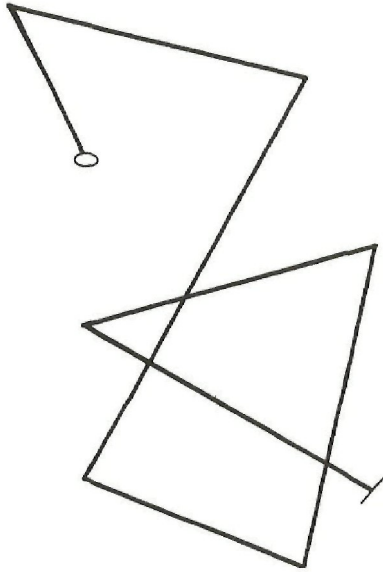

Spirit of Absolution

Pontimas - Spirit of Absolution. Pontimas appears as an old man, beaming with wisdom and compassion. The magician will be in awe at how quickly Pontimas can be trusted and becomes a confidant. There is no secret or wicked past that would cause this Spirit's understanding eyes to look away.

Pontimas will guide the evocator in clearing his karma and ridding himself of his negative attachments. He gives remarkable spiritual exercises that will aid in this process, bringing the Summoner closer to his own Divinity. Pontimas knows that even the darkest conscience can be cleansed and that even the brightest soul needs improvement.

Sakatos

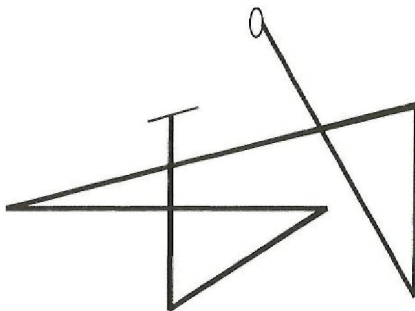

Cleansing Angel

Sakatos - Cleansing Angel. Sakatos manifests as a strong angel riding in the center of a whirlwind. His arms are outstretched, fingers touching the walls of the wind tunnel. His voice is strong and clear even above the swirling din around him.

Sakatos will clear any obstacle from the magician's path of Ascent and will chase chaos away with the mighty wind that surrounds him.

Ismaelta

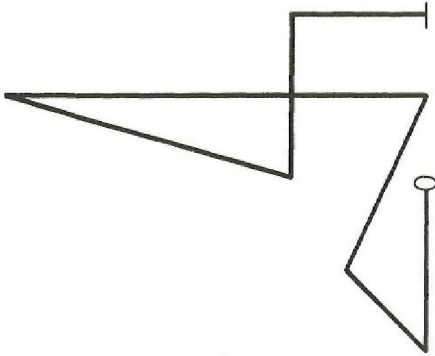

Demon Guardian

Ismaelta - Demon Guardian. Ismaelta appears as a mercenary, fully armored in tarnished steel and armed with a large sword and several knives sheathed in his armor.

The Demon will find and destroy any force, person, or sorcerer that would keep the Evocator from his work. Once he is summoned, Ismaelta will guard the Operator at all times.

Alkalon

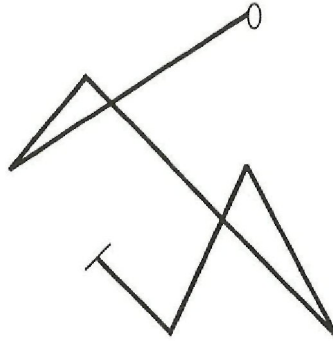

Spirit of Alchemy

Alkalon - Spirit of Alchemy. Alkalon appears as a very noble man surrounded by a golden aura. The most notable thing about his manifestation is that the Spirit seems to take on a more solid manifestation than any other, at times having a form that is so concrete that he could pass as a physical being in a crowd of people.

Alkalon teaches the magician how to transform copper into gold, how to create matter from energy, to change stones into bread and, most remarkably, how to translate the self into the Divine.

Tanazal

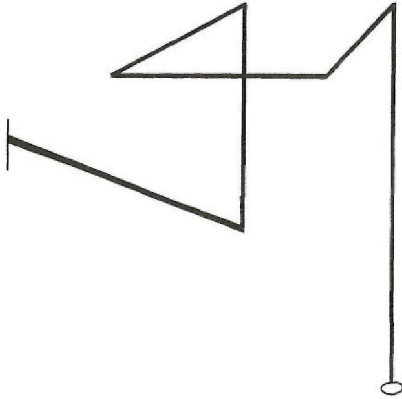

Demon of Illusion

Tanazal - Demon of Illusion. Tanazal manifests suddenly before the Operator, and appears to have difficulty maintaining his form, as the solidity of it fades and reappears in full vibrancy throughout the evocation. The Demon wears a long black cloak over solid black clothing. His dark hair barely falls to his shoulders. His eyes are almost always green when he first appears, but change colors as the evocation proceeds.

Tanazal causes men to chase after shadows and false powers, as to never find the True Path. He is a most dangerous demon, creating a spiritual labyrinth that is nearly inescapable.

Letana

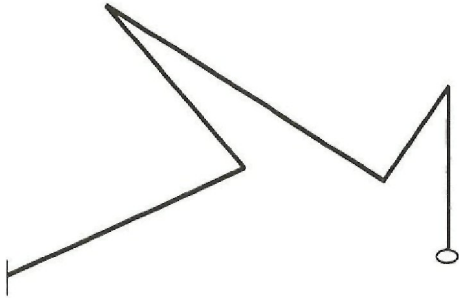

Encouraging Angel

Letana - Encouraging Angel, Letana comes as beautiful but pure woman, young yet still very wise. She wears a lacy, white gown that covers her slender body. Her blue eyes are always slightly moistened with tears of compassion.

Letana gives courage and strength when despair prevails.

Frotasch

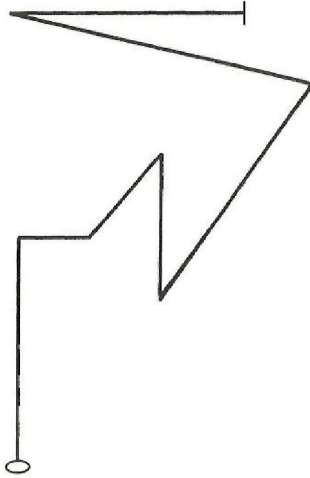

Spirit Guide

Frotasch - Spirit Guide. Frotasch appears as a definite apparition, manifesting on the physical plane in a subtle and semi-transparent form. He will explain, if asked, that doing so allows him to more quickly dissolve his materialized form and re-enter the Astral Plane with greater ease.

Frotasch will guide the magician through the veils and portals of the Astral Plane, teaching him the secrets of gaining power over each. In time, under the Angel's direction, the magician will even learn to move above the planes of causality into the domain of the Gods.

Haask

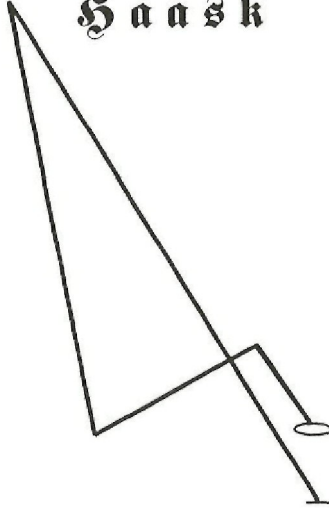

Angel of the Armory

Haask - Angel of the Armory. Haask appears as a sentinel, large in size and build and well armed. He wears no headdress or helmet, the masculine features of his face clearly visible. His blond hair is tied behind his head in a tight ponytail

Haask will give to the Adept that has prepared himself the tools and weapons of the Gods. He will explain what each is used for and will give exercises by which one may be prepared to receive them.

A	X	K	D	Z
N	E	H	T	R
L	L	A	A	T
P	T		O	K
L	R	A	U	A

Fourth Kingdom of Flames

The Fourth Kingdom of Flames was much smaller than those Kingdoms to which I had previously traveled. Not at all like the often dark and dreadful spiritual landscapes before, I entered instead an immense metallic room. It appeared to be constructed of some type of black steel, seamed and bolted vertically up the walls.

The room itself formed a three-dimensional polyhedron around me, a flat hexagonal floor beneath that spread about twenty feet in the longest line. The walls slanted outwards halfway to the ceiling, at which point they slanted at the exact same angle inwards,

meeting a ceiling of the same size and shape as the floor. My estimation of the full shape of the room is that of an icosahedron

The greatest difference that struck me between this Kingdom and the others, however, was the mathematical perfection in the construction of the place. Each angle of each wall appeared to be exact, as did the angles of each polygon that comprised them. Where the others were made in beauty and majesty, this was made in precision.

Inscribed in thick lines into the metallic surface of the floor was the Square of the Fourth Kingdom of Flames, the ceiling bearing an exact symmetrical copy, the letters being in the reversed order on each line. At this discovery, I could think nothing but the thought that I was standing inside of a magickal and mathematical continuum, a nexus between the worlds of matter, energy and thought.

Zadkal

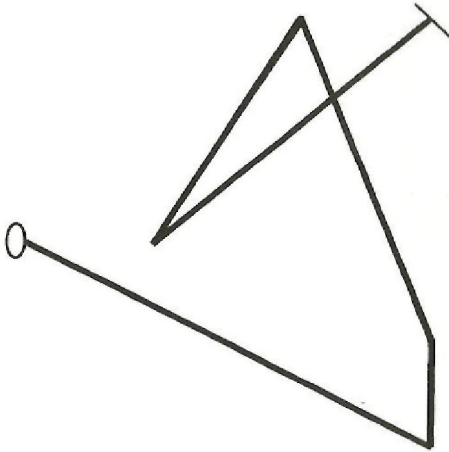

Grand Spirit of the Fourth Kingdom of Flames

Zadkal - Grand Spirit of the Fourth Kingdom of Flames. Zadkal appears as a slender young man with short hair and soft skin. He speaks in a manner similar to a child that is full of knowledge that he cannot contain. When asked a direct question, however, the Grand Spirit's agelessness and wisdom is irrefutable.

Zadkal is the Grand Spirit of all science and art. In these arenas he is expert and will teach them to perfection with the greatest patience and preciseness.

Although all of the entities listed in this grimoire have legions of familiars which the magician may employ if he only asks, Zadkal is one of the few that will first offer to assign these to aid in the magician in his studies. It is advised to take full advantage of this offer.

Luttal

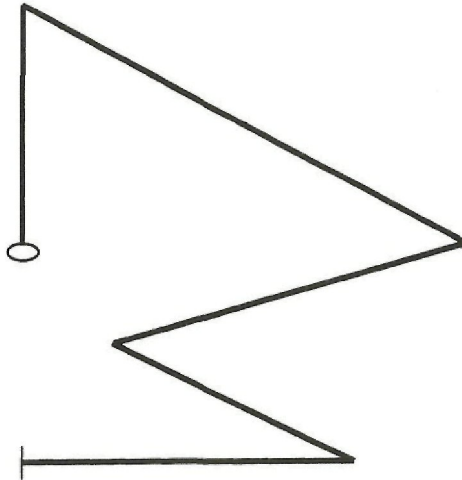

Spirit of the Stars

Luttal - Spirit of the Stars. Luttal appears as an old man with long, white, unkempt hair and disheveled clothing. He is always possessed of a fanatical expression, constantly frantic about the next discovery he can aid in manifesting.

Luttal teaches the movements of the stars and the alignment of the planets. In teaching, Luttal has the ability to project images of what he is explaining into the air or a skrying device.

Xeroph

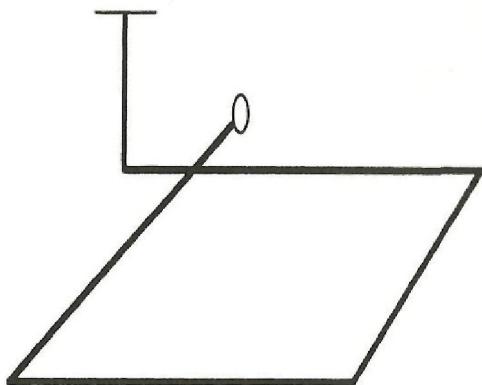

Xeroph - Spirit of Stones. Xeroph appears as a strong man whose hair is just beginning to grey. He wears the attire of a Sultan, loose white pants and shirt tied at the waist with a silver sash. His full, grey beard is well groomed.

Xeroph teaches the secrets of gems and stones, and how such may be used for power and wealth, His main focus is to show that all things have energy and life, and to teach his student how this force may be utilized to its fullest potential.

Rantka

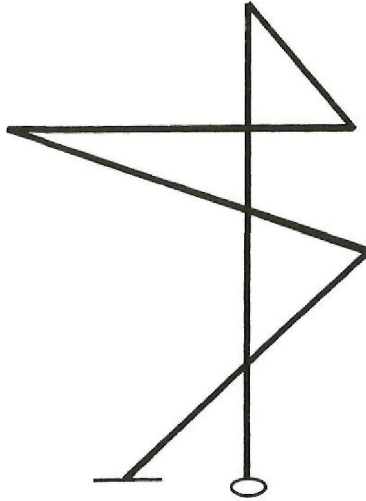

Healing Angel

Rantka - Healing Angel. Rantka appears as a healthy man with short, dark hair that is always well groomed. He is clean shaven, and his white robes are perfectly fitting. This precision that he demonstrates in his appearance is also heard in his speech.

The Angel Rantka teaches both magickal and scientific methods of healing, and will show the Summoner how the two are inseparably linked.

Along with instruction in the methods of directing healing energy and using medical techniques to their appropriate ends, Rantka teaches the use of herbs and minerals to both heal the body and enliven the mind.

Although he prefers to teach the magician to heal, the Angel can cure any disease with a touch when constrained to do so.

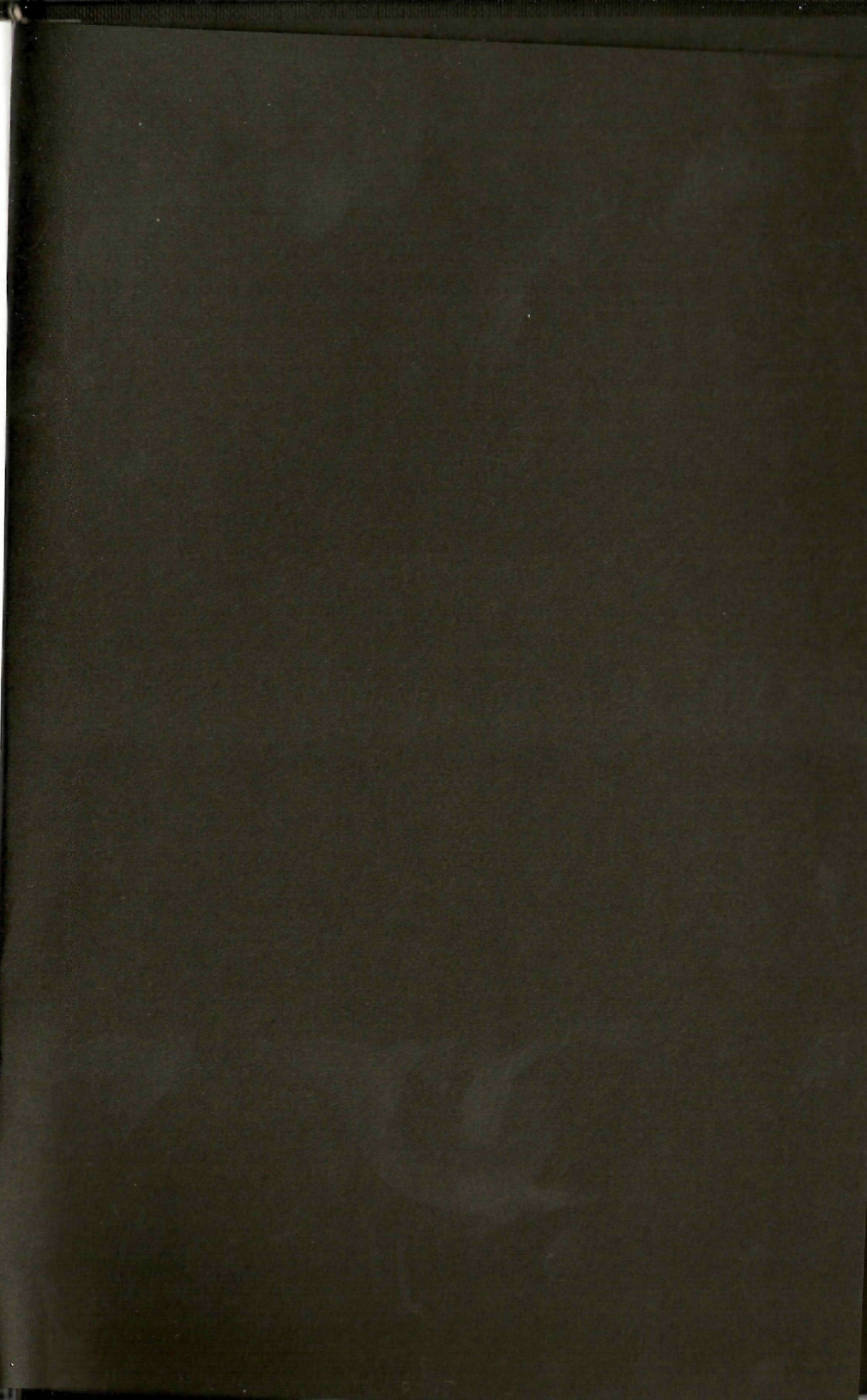

ARCHAELUS BARON

KINGDOMS OF FLAME

IXXXAR