

THE UNIVERSITY OF CHICAGO  
ORIENTAL INSTITUTE PUBLICATIONS  
VOLUME 132

*Series Editors*

Leslie Schramer

*and*

Thomas G. Urban

*with the assistance of*

Katie L. Johnson





# THE EGYPTIAN COFFIN TEXTS

## VOLUME 8

### MIDDLE KINGDOM COPIES OF PYRAMID TEXTS

by  
JAMES P. ALLEN

PT 213

L-A1	M1C	S5C
-B 30-	-29-	-1-
		
1*		

Library of Congress Control Number: 2005930911

ISBN: 1-885923-40-6

ISSN: 0069-3367

©2006 by The University of Chicago. All rights reserved.

Published 2006. Printed in the United States of America.

*The Oriental Institute, Chicago*

*Title Page Illustration*

Portion of Pyramid Text 213

*Spine Illustration*

Gardiner Hieroglyph A26, man with one arm raised in invocation

*Printed by McNaughton & Gunn, Incorporated, Saline, Michigan*

The paper used in this publication meets the minimum requirements of American National Standard for Information Services — Permanence of Paper for Printed Library Materials, ANSI Z39.48-1984.



## TABLE OF CONTENTS

LIST OF ABBREVIATIONS.....	vii
LIST OF SOURCES.....	ix
PREFACE.....	xiii
INTRODUCTION.....	xv
THE AUTOGRAPHED TEXTS.....	1



## LIST OF ABBREVIATIONS

AdB	Adriaan de Buck (copyist of the Coffin Texts Project)
AHG	Alan H. Gardiner (copyist of the Coffin Texts Project)
B	bottom
ca.	<i>circa</i> , about
C	ceiling
cf.	<i>confer</i> , compare
col(s).	column(s)
CT	Coffin Texts — arabic numerals refer to spells, and roman plus arabic numerals to volume and page numbers, of Adriaan de Buck, <i>The Egyptian Coffin Texts</i> (Seven volumes; Oriental Institute Publications 34, 49, 64, 67, 73, 81, 87; Chicago, 1935–61)
CTN	notebooks of the Coffin Texts Project
CTP	Coffin Texts Project
E	east (side or wall, with column or line numbers: for front, see p. xv)
Ext.	exterior (with column or line numbers)
frag.	fragment
gr.	group, groups (of hieroglyphic text)
Int.	interior (with column or line numbers)
L	lid
LSB	Ludlow S. Bull (copyist of the Coffin Texts Project)
n.	note
N	north (side or wall, with column or line numbers: for head, see p. xv)
N	Pyramid Texts of Pepi II published by Gustave Jéquier, <i>Le monument funéraire de Pepi II</i> , Volume 1: <i>Le tombeau royal</i> (Three volumes; Service des Antiquités de l'Égypte, Fouilles à Saqqarah; Cairo, 1936)
Nt	Pyramid Texts of Queen Neith published by Gustave Jéquier, <i>Les pyramides des reines Neit et Apouit</i> (Service des Antiquités de l'Égypte, Fouilles à Saqqarah; Cairo, 1933)
p(p).	page(s)
P	Pyramid Texts of Pepi I published by Jean Leclant, editor, <i>Les textes de la pyramide de Pépy Ier</i> (Two volumes; Mémoires publiés par les membres de l'Institut français d'archéologie orientale du Caire 118; Cairo, 2001)
PT	Pyramid Texts — spell numbers of Kurt Sethe, <i>Die altägyptischen Pyramidentexte nach den Papierabdrücken und Photographien des Berliner Museums</i> (Four volumes; Hildesheim, 1960 and 1969; Second edition)
Pyr.	Pyramid Texts — section (“paragraph”) numbers of Kurt Sethe, <i>Die altägyptischen Pyramidentexte nach den Papierabdrücken und Photographien des Berliner Museums</i> (Four volumes; Hildesheim, 1960 and 1969; Second edition)
S	south (side or wall, with column or line numbers: for foot, see p. xv)
W	west (side or wall, with column or line numbers: for back, see p. xv)



## LIST OF SOURCES

SIGLUM	DESIGNATION	PROVENIENCE	CURRENT LOCATION
Ab1Le	Outer coffin of <i>Hrj-šj.f-ḥtp</i>	Abusir	Leipzig Inv. 4,3
Ab2Le	Inner coffin of <i>Hrj-šj.f-ḥtp</i>	Abusir	Leipzig Inv. 4,3
B1Bo	Outer coffin of <i>Dḥwtj-nḥt</i>	Bersha	Boston MFA 20.1822–27
B2Bo	Inner coffin of <i>Dḥwtj-nḥt</i>	Bersha	Boston MFA 21.962–63
B3Bo	Outer coffin of <i>Dḥwtj-nḥt</i> (f)	Bersha	Boston MFA 21.964–65
B4Bo	Inner coffin of <i>Dḥwtj-nḥt</i> (f)	Bersha	Boston MFA 21.966–67
B6Bo	Outer coffin of <i>Zṣt-mkwt</i> (f)	Bersha	Boston MFA 21.810–11/968
B4C	Outer coffin of <i>Zṣt-ḥd-ḥtp</i> (f)	Bersha	Cairo 28086
B6C	Coffin of <i>ḥṣ-nḥt &gt; kṣy/dḥwtj-nḥt</i> (f)	Bersha	Cairo 28094
B9C	Middle coffin of <i>Jmn-m-ḥṣt</i>	Bersha	Cairo 28091
B10C	Outer coffin of <i>Jmn-m-ḥṣt</i>	Bersha	Cairo 28092
B14C	Coffin of <i>D&lt;ḥwtj-nḥt&gt; ḥnw</i> (f)	Bersha	Cairo 28099
B16C	Outer coffin of <i>Nfr</i>	Bersha	Cairo 28088
B17C	Inner coffin of <i>Nfr</i>	Bersha	Cairo 28087
B19C	Canopic box of <i>Dḥwtj-nḥt</i> (f)	Bersha	Cairo 4740
B1P	Outer coffin of <i>Zp</i>	Bersha	Louvre E 10779A
BH1Br	Coffin of <i>Mṣ</i>	Beni Hasan	Brussels E 5037
BH1C	Inner coffin of <i>Zkr-m-ḥṣt/tṣw</i>	Beni Hasan	Cairo J 37564a
BH3C	Outer coffin of <i>Nfry</i>	Beni Hasan	Cairo J 37563b
BH4C	Coffin of <i>Ntrw-ḥtp</i>	Beni Hasan	Cairo J 37565
BH5C	Coffin of <i>Hnmw-nḥt</i>	Beni Hasan	Cairo J 37569
BH6C	Inner coffin of <i>Nfry</i>	Beni Hasan	Cairo J 37563a
BH1Ox	Outer coffin of <i>Ntr-nḥt</i> (f)	Beni Hasan	Ashmolean E 3906
BH2Ox	Inner coffin of <i>Ntr-nḥt</i> (f)	Beni Hasan	Ashmolean E 3907
L-A1	Coffin of <i>ḥnḥt</i> (f)	Lisht	Unknown
L-BnrA	Model coffin of <i>Bnr</i>	Lisht	New York MMA 11.151.763
L-D1	Coffin of <i>Dbḥ.n.j</i>	Lisht	New York MMA
L-HM	Coffin of <i>Hnwt-mṣt</i> (f)	Lisht	Unknown
L-JMH1	Tomb chamber of <i>J-m-ḥtp</i>	Lisht	In situ
L-KhPM2	Coffin of <i>Hnsw-pts-mṣt</i> (f)	Lisht	Unknown
L-MH1A	Sarcophagus of <i>Mntw-ḥtp</i>	Lisht	In situ
L-Nnj1	Coffin of <i>Nnj</i>	Lisht	Unknown
L-PW1A	Coffin of <i>Pth-wnn.f</i>	Lisht	Unknown
L-PW1B	Canopic box of <i>Pth-wnn.f</i>	Lisht	Unknown
L-S1B	Inner coffin of <i>Zṣt-spy/snbtj.s</i> (f)	Lisht	New York MMA 08.200.45
L-Snb2	Mummy mask of <i>Snb</i>	Lisht	New York MMA 15.3.152
L-SS1A	Doorjamb of <i>Shṭp-jb-r ḥ-snb</i>	Lisht	Unknown
L-SS1B	Doorjamb of <i>Shṭp-jb-r ḥ-snb</i>	Lisht	New York MMA 09.180.2654 (now Mexico Museo Nacional de Antropología)
L-SS1C	Doorjamb or pillar of <i>Shṭp-jb-r ḥ-snb</i>	Lisht	Unknown
L-WN1A	Model coffin of <i>Wṣḥ-nfr-ḥtp</i>	Lisht	New York MMA 14.3.69A–B
L-Wsr1	Tomb chamber of <i>Wsr</i>	Lisht	New York MMA 33.1.173
L-X13	Coffin fragment	Lisht	Unknown

SIGLUM	DESIGNATION	PROVENIENCE	CURRENT LOCATION
L2Li	Interior coffin of <i>Ssnb.n.f</i>	Lisht	Unknown
L3Li	Coffin of <i>Nht</i>	Lisht	Unknown
L1NY	Coffin of <i>Hty</i>	Lisht	New York MMA 32.1.133
M1C	Inner coffin of <i>Rrwt</i> (f)	Meir	Cairo J 42949
M2C	Coffin of <i>Hnmw-htp &gt; hnn</i>	Meir	Cairo J 42947
M5C	Coffin of <i>Nht-hwt-hrw</i> (f) > <i>nht</i> (f)	Meir	Cairo J 42826
M7C	Outer coffin of <i>Wr-nfr</i>	Meir	Cairo 28037
M18C	Coffin of <i>Hn hrj-jb</i>	Meir	Cairo 28075
M25C	Coffin fragments of <i>Nfr-s3b</i> (f)	Meir	Cairo 28078–9r
M28C	Coffin of <i>Wh-htp</i>	Meir	Cairo 28040
M37C	Coffin of <i>Snb</i>	Meir	Cairo 28041
M57C	Coffin of <i>Sbkw-hr-h3b</i>	Meir	Cairo
M58C	Coffin of <i>Wh-stp</i>	Meir	Cairo 28067
M1NY	Coffin of <i>Wh-stp</i>	Meir	New York MMA 12.182.132
R1X	Coffin of <i>Jmny &gt; Jn-jt.f</i>	Riqqa	Unknown
S1C	Inner coffin of <i>Mzhtj</i>	Asyut	Cairo 28118
S2C	Outer coffin of <i>Mzhtj</i>	Asyut	Cairo 28119
S5C	Coffin of <i>T3w3w</i>	Asyut	Cairo J 45064
S10C	Coffin of <i>Jr &gt; 'nh.f</i>	Asyut	Cairo J 44980
S14C	Coffin of <i>Hnwt-n.j</i> (f)	Asyut	Cairo J 44981
Sed1Cam	Coffin of <i>Jn- 'nh</i>	Sedment	Cambridge Ethnological Museum
Sed1Cop	Cuter coffin of <i>K3-nht</i>	Sedment	Copenhagen AEIN 1585(formerly Sid2X)
Sed2Cop	Inner coffin of <i>K3-nht</i>	Sedment	Copenhagen AEIN 1586(formerly Sid3X)
Sed1Sed	Outer coffin of <i>Hntj-ht</i>	Sedment	Unknown
Sq2Be	Outer coffin of <i>Jpj- 'nh.w</i>	Saqqara	Berlin 10185
Sq3Be	Coffin of <i>Hwt-hntj-ht</i> (f)	Saqqara	Berlin 10185
Sq1C	Coffin of <i>Z3t-b3stt</i> (f)	Saqqara	Cairo 28034
Sq2C	Coffin of <i>Hpr-k3-r</i> c	Saqqara	Cairo 28036
Sq3C	Inner coffin of <i>Nfr-m3dnjt</i> (f)	Saqqara	Cairo J 39014
Sq4C	Inner coffin of <i>Hnw</i>	Saqqara	Cairo J 39052
Sq5C	Inner coffin of <i>K3-rnn</i>	Saqqara	Cairo J 39054a
Sq6C	Outer coffin of <i>K3-rnn</i>	Saqqara	Cairo J 39054b
Sq7C	Coffin of <i>Hr</i>	Saqqara	Cairo 28035
Sq9C	Coffin of <i>Jnpw-m-h3t</i>	Saqqara	Cairo 8/1//30/1
Sq10C	Coffin, perhaps outer to Sq9C	Saqqara	Cairo 18/1//27/3
Sq12C	Outer coffin, perhaps of <i>Wsr-mjw</i> t	Saqqara	Cairo 18/1//27/2
Sq13C	Coffin of <i>Hrj-3j.f-htp</i>	Saqqara	Cairo 8/1//30/2
Sq1Ch	Coffin of <i>Jpj-h3-j3wt.f</i>	Saqqara	Chicago OIM 12072
Sq1Cop	Inner coffin of <i>Gm.n.j</i>	Saqqara	Copenhagen AEIN 1615(formerly Sq2X)
Sq1Sq	Burial chamber of <i>Sk-wsh</i> t	Saqqara	In situ
Sq1X	Inner coffin of <i>Gm.n.j</i>	Saqqara	Unknown
T1Be	Outer coffin of <i>Mntw-htp</i>	Thebes	Berlin 9
T2Be	Middle coffin of <i>Mntw-htp</i>	Thebes	Berlin 10
T3Be	Coffin of <i>Sbkw- 3</i>	Thebes	Berlin 45
T4Be	Sarcophagus of <i>Jn-jt.f</i>	Thebes	Berlin 1154

LIST OF SOURCES

SIGLUM	DESIGNATION	PROVENIENCE	CURRENT LOCATION
T1C	Tomb chamber and coffin of <i>Srw-htp</i>	Thebes	Cairo 28023
T2C	Sarcophagus of <i>Dꜣg</i>	Thebes	Cairo 28024
T7C	Coffin of <i>Nbw-ḥr-rdj</i> (f)	Thebes	Cairo 28030
T8C	Coffin of <i>Jmnt</i> (f)	Thebes	Cairo 28026
T9C	Coffin of <i>Mntw-htp/bwꜣw</i>	Thebes	Cairo 28027
T13C	Coffin of <i>Smn-htp</i>	Thebes	Cairo 28126
T1L	Outer coffin of <i>Jmꜣ</i>	Thebes	London BM 6654
T1NY	Coffin of <i>Nsw</i>	Thebes	New York MMA 27.3.73 (now Detroit IA 65.394)
TT 240	Tomb chamber of <i>Mrw</i>	Thebes	In situ
TT 319	Tomb chamber of Queen <i>Nfrw</i>	Thebes	In situ





## PREFACE

With the appearance of this volume, the Oriental Institute marks the true completion of the Egyptian Coffin Texts Project, an international cooperative program begun by James Henry Breasted and Alan H. Gardiner in 1922 and edited by Adriaan de Buck from 1935 until his death in 1959. When published in 1961, volume 7, de Buck's final volume, was announced as "the last volume of the *autographed Coffin Texts* in the contemplated Project" (p. vii), although the Oriental Institute had never produced the autographed edition of Pyramid Texts within the Coffin Text corpus that had been explicitly promised in the introduction to volume 1. Assumed to comprise a "distinct" and "foreign body" within the Coffin Texts, these long-lived spells were "reserved for later" (p. xi). After a lapse of forty years, a formally renewed Coffin Texts Project was authorized by the Director in 2001, with the goal of completing the Oriental Institute's outstanding commitments. The translation volume once envisioned and entrusted to Tjalling Bruinsma had been rendered unnecessary by the publications of Raymond O. Faulkner in 1969 (Pyramid Texts) and 1973–1978 (Coffin Texts), which serve to engage scholars and laymen alike. Glossaries, bibliographies, symposia, and detailed textual studies appeared, but the critical edition of Middle Kingdom Pyramid Texts remained unaccomplished. By careful examination of the Oriental Institute's original collation sheets and unpublished sources from Lisht, James P. Allen, after years of concentrated study, has now fulfilled the task admirably. It is hoped that the new edition stimulates discussion not only of the longevity of the Pyramid Texts, but of the nature of the Coffin Texts themselves. While Breasted insisted that the Pyramid Texts were "sharply distinguished" from the Coffin Texts,<sup>1</sup> the frequent appearance of "Pyramid Texts" on coffins (among the narrowly defined "Coffin Texts") leaves this opinion open to question. Ironically, the one coffin acquired in Chicago by Breasted for study by the Coffin Texts Project (OIM 12072) contained only "Pyramid Texts" and was therefore excluded from the initial seven volumes. Now at last these Middle Kingdom texts on a coffin can be examined among the "Coffin Texts."

Robert K. Ritner

Director, The Egyptian Coffin Texts Project, 2001–2006

---

<sup>1</sup>James Henry Breasted, *The Oriental Institute* (The University of Chicago Survey 12; Chicago, 1933), p. 152.



## INTRODUCTION

The seven volumes of Adriaan de Buck's monumental publication of the ancient Egyptian Coffin Texts represent only one part, though by far the greatest, of the task undertaken by the Coffin Texts Project of the Oriental Institute. In the introduction to the first of these volumes, de Buck noted that "it has been proved both practical and possible to separate the bulk of the Pyramid Texts occurring in our coffins from the rest [of their texts]" and that "The publication of these later copies of the Pyramid Texts has been reserved for later."<sup>2</sup> This portion of the project, which de Buck's unfortunate death shortly before the appearance of volume 7 of *The Egyptian Coffin Texts* in 1961 prevented him from completing, is represented by the present volume.

The format and conventions of this volume follow for the most part those of the first seven *Egyptian Coffin Texts*,<sup>3</sup> with a few exceptions. The texts have been arranged according to the spell and "paragraph" numbers of Kurt Sethe's edition of the Pyramid Texts.<sup>4</sup> Supplementary texts not found in Sethe's edition are presented on pp. 441 ff. These include spells with earlier parallels in the pyramids of the Old Kingdom, as well as unpublished texts without known parallels from individual Middle Kingdom sources, some of which were given "CT Temp" numbers by the Coffin Texts Project.<sup>5</sup> In the autographed texts the individual sources are arranged alphabetically by their sigla (for which, see pp. ix–xi, above), which reflect their geographic origin. In a few cases it has been necessary to present an autographed text in landscape mode in order to accommodate the number of sources without resorting to folded pages. In place of the elegant hand of de Buck's autograph of the Coffin Texts, the autograph in this volume has been prepared using a computer font created by the Metropolitan Museum of Art and a commercial vector-based drawing program (CorelDraw).

The texts themselves have been taken primarily from the photographs and autographed notebooks of the Coffin Texts Project, which are preserved in the Oriental Institute Archives. These have been supplemented by previously unpublished texts from the Middle Kingdom coffins and monuments discovered by the excavations of the Metropolitan Museum of Art at Lisht, preserved in the collection and excavation records of the museum. Texts from Middle Kingdom sources published elsewhere have generally not been included, with the exception of those which were also recorded by the Coffin Texts Project or the Metropolitan Museum of Art's Lisht expedition. The sigla and column or line numbers of the sources recorded by the Coffin Texts Project are those assigned by the project, and the project's conventions for referring to the individual sides of these sources have also been followed.<sup>6</sup> The columns and lines of coffins, sarcophagi, and tomb chambers discovered by the Metropolitan Museum of Art's excavations at Lisht have been numbered according to a different convention, which reflects the original geographic orientation of the monument. The columns and lines on the walls of the tomb chambers are numbered by wall rather than sequentially throughout the entire monument, with a prefix indicating the wall in question: N (North), S (South), W (West), E (East), and C (Ceiling). Those of the coffins and sarcophagi are numbered similarly: N (North = Head), S (South = Foot), W (West = Back), E (East = Front), L (Lid), and B (Bottom).

The present volume represents the culmination of work begun in 1970 in conjunction with research for my doctoral dissertation,<sup>7</sup> and in 1990 for a publication of the texts from Lisht.<sup>8</sup> I am grateful to the directors of the Oriental Institute, in particular the late George R. Hughes, who initially gave me access to the records of the Coffin Texts Project and permission to publish these texts, and Janet H. Johnson, who has made the present publication possible; to Katie L. Johnson, Robert K. Ritner, and Thomas G. Urban, who have overseen its publication; to John A. Larson and Harold M. Hays, who helped with research in the Coffin Texts notebooks; and to Dieter Arnold, Director of the Metropolitan Museum's excavations at Lisht since 1984, and Dorothea Arnold, Head of the museum's Department of Egyptian Art, who have allowed me to include the Lisht texts in this publication.

---

<sup>2</sup>*The Egyptian Coffin Texts*, Volume 1: *Texts of Spells 1–75* (Oriental Institute Publications 34; Chicago, 1935), p. xi.

<sup>3</sup>For which, see Adriaan de Buck, *The Egyptian Coffin Texts*, Volume 1, pp. xiii–xv.

<sup>4</sup>Kurt Sethe, *Die altägyptischen Pyramidentexte nach den Papierabdrücken und Photographien des Berliner Museums* (Four volumes; Hildesheim, 1960 and 1969; Second edition).

<sup>5</sup>For a list of CT Temp numbers, see Thomas G. Allen, *Occurrences of Pyramid Texts with Cross Indexes of These and Other Egyptian Mortuary Texts* (Studies in Ancient Oriental Civilization 27; Chicago, 1950), pp. 122–33. Most of these were eventually incorporated in de Buck's publication of the Coffin Texts.

<sup>6</sup>See Leonard H. Lesko, *Index of the Spells on Egyptian Middle Kingdom Coffins and Related Documents* (Berkeley, 1979).

<sup>7</sup>See James P. Allen, *The Inflection of the Verb in the Pyramid Texts* (Bibliotheca Aegyptia 2; Malibu, 1984), p. xvi.

<sup>8</sup>For the full publication of these monuments, see James P. Allen, *Funerary Texts from Lisht 1* (New York, 2006).



## THE AUTOGRAPHED TEXTS





	BH1C	BH3C	BH6C	BH10x	BH20x
16a	-23- 	-64- 	-2- 	-42- 	-19- 
16b	-25- 	-66- 			

	BH1C	BH3C	BH6C	BH10x	BH20x
(16b)			-5- 	-44- 	
16c		-66- 		-45- 	
16d					
	PT 25 follows	PT 25 follows	PT 25 follows	PT 25 follows	PT 25 follows

	BH1C	BH3C	BH6C	BH10x
(16d)	-23A- 	-63- 	-1- 	-41- 
	4*	5*	6*	7*

Notes to p. 5:

- 1\* Dashed lines mark signs copied by Passalacqua.
- 2\* Passalacqua , probably .
- 3\* Top corrected over (of zp).
- 4\* seen only by Lacau.
- 5\* and top of over erasure.

- 1\* Dashed lines mark signs seen only by Lacau.
- 2\* Group with final reed-leaf of N.
- 3\* This is the of , serving double purpose.
- 4\* Over cols. 23–28.
- 5\* Over cols. 64–66.
- 6\* Over cols. 2–9.
- 7\* A long line over the whole Front, but only this portion inscribed (over cols. 42–43).



	B2Bo <sup>a</sup>	B2Bo <sup>b</sup>	BH1C	BH3C	BH6C	BH10x <sup>a</sup>	BH10x <sup>b</sup>	BH20x	T2Be	T1C	T9C
17a	-18- 	-466- 	-29- 	-68- 	-11- 	-48- 	-71- 	-27- 	-104- 	-232- 	-(24)- 
17b											

For notes see p. 4.

# (PT 25)

	B2B0 <sup>a</sup>	B2B0 <sup>b</sup>	BH1C	BH3C	BH6C	BH10x <sup>a</sup>	BH20x	S5C	T2B <sub>e</sub>	T1C	T9C
17c											
								CT 894 follows			
											End of col. and Head
18a											

For notes see p. 7.

	B2Bo <sup>a</sup>	B2Bo <sup>b</sup>	BH1C	BH3C	BH6C	BH10x <sup>a</sup>	BH20x	Sq10C	T2Be	T1C
18b	<p>...</p> <p>-21-</p> <p>...</p>		<p>-36-</p> <p>1*</p>			<p>2*</p>	<p>2 1/2 gr. blank</p> <p>...</p> <p>-35-</p> <p>...</p> <p>End of col. and Front</p>	<p>...</p> <p>3*</p>	<p>-234-<sup>sic</sup></p> <p>3*</p>	
18c	<p>...</p> <p>-22-</p> <p>-470-</p>	<p>-37-</p> <p>4*</p>	<p>-71-</p> <p>4*</p>	<p>-19-</p> <p>5*</p>	<p>5*</p> <p>54-</p> <p>-20-</p>	<p>-132-</p> <p>-133-</p> <p>-112-</p> <p>7*</p>	<p>6*</p>			

Notes to p. 6:

- 1\* Group with final reed-leaf of N.
- 2\* As end of PT B1.
- 3\* Copy has , for .
- 4\* Publ. , for .
- 5\* Publ. , but perhaps nothing.

- 1\* seen only by Lacau.
- 2\* Small signs added secondarily.
- 3\* Publ. , for .
- 4\* Group with following.
- 5\* Group with final reed-leaf of N.
- 6\* Publ. , for .
- 7\* Publ. , for .

18d

B2Bo <sup>a</sup>	B2Bo <sup>b</sup>	BH1C	BH3C	BH6C	BH10x <sup>a</sup>	Sq10C	T2Be	T1C
End of col. and Head	PT 32 follows	PT 32 follows	PT 32 follows	End of col. and Head	PT 32 follows	PT 220 follows	End of section	CT 530 follows

(18d)

BH1C	BH3C	BH6C	BH10x <sup>a</sup>	T9C
3*	4*	5*	6*	7*

- 1\* Group with preceding.
- 2\* added secondarily.
- 3\* Over cols. 29-38.
- 4\* Over cols. 68-71.
- 5\* Over cols. 11-21.
- 6\* Under cols. 48-49.
- 7\* Over cols. 15-24, as title to CT 530 and PT 25.

PT 27-30

PT 27	PT 28	PT 29			PT 30		
19b	19c	20a	20b	20c	20d	21a	21b
ca. 6½ groups PT 81 follows	PT 27 follows					PT 30 follows	PT 28 follows

	B2B <sub>0</sub>	BH1C	BH3C <sup>a</sup>	BH3C <sup>b</sup>	BH10x
22a	-471- 	-39- 	-73- 	-95- 	-55- 
22b					

	B2B <sub>0</sub>	BH1C	BH3C <sup>a</sup>	BH3C <sup>b</sup>	BH10x
(22b)					
23a					
23b	-474- 				-59- 

BH1C	BH3C <sup>a</sup>	BH3C <sup>b</sup>	BH10x
-39A- 	-72- 	-94- 	-(55)- 
8*	9*	10*	11*

- 1\* Group with final reed-leaf of N (sic), inserted secondarily.
- 2\* Group with final reed-leaf of N.
- 3\* PT 82 follows.
- 4\* PT 34 follows.
- 5\* PT 43 follows.
- 6\* This is the of the col.
- 7\* PT 35 follows.
- 8\* Over cols. 39-47.
- 9\* Over cols. 73-75.
- 10\* Top of col. 95.
- 11\* End of col. 55, after N pn.

End of col. and Front

PT 34

	BH3C	BH10x
26a	-77- 	-67- 
26b		

	BH3C	BH10x
26c		
26d		

	BH3C	BH10x
26e		
26f		

	BH3C	BH10x
(26f)	-76- 	-60- 

- 1\* added secondarily.
- 2\* added secondarily.
- 3\* probably added secondarily.
- 4\* Over cols. 77-78.
- 5\* Part of a line under cols. 50-71. Pyr. 27e and 29c follow without separation.
- 6\* As the end of PT 36.
- 7\* Part of a line under cols. 50-71. Pyr. 26f precedes and 29c follows without separation.

PT 35

	Sq15q
27a	

	Sq15q
27b	

	BH10x	Sq15q
27d	-65- 	6* 

	BH10x	Sq15q
(27d)	-66- 	

	Sq15q
27e	-(60)- 

PT 34 follows CT 530 follows

	BH3C	BH10x
28a	- 81 - 	- 61 - 
28b		
	- 82 - 	- 62 - 
	- 83 - 	- 63 - 

	BH3C	BH10x
28c		
29a		- 64 - 
		2* 
		3* 

	BH3C
29b	
	PT 37 follows

	BH3C	BH10x
29c	- 80 - 	- (60) - 
	4* 	
		5* 

- 1\* (s)ntr added secondarily.
- 2\* Perhaps room for plural strokes.
- 3\* Pyr. 27d (PT 35) follows as end of this spell.
- 4\* Above cols. 83-84.
- 5\* Part of a line under cols. 50-71. Pyr. 26f and 27c precede without separation.

PT 37-43

PT 37	PT 38A	PT 39	PT 40	PT 41	PT 42	PT 43
BH3C	BH3C	BH3C	BH3C	BH3C	BH3C	BH3C
<p>30a</p>	<p>30b</p>	<p>31b</p> <p>31a</p>	<p>31c</p> <p>30b</p>	<p>32a</p>	<p>32b</p> <p>PT 32 follows</p>	<p>33a</p> <p>End of col. and Front</p>

1\* Pyr. 30b for Pyr. 31a text.  
 2\* Above cols. 93-96.  
 3\* apparently added secondarily.  
 4\* apparently added secondarily.



PT 58

PT 59

PT 62 (A-B)

PT 63

41a

B16C

-30-

41b

B16C

-29-

43a

B16C Sq3C Sq6C Sq1Sq

-25b- -94- -82- -99-

43b

-96-

44c

B16C Sq3C

-(24a)- -(96)-

44a

B16C Sq3C

-23a-

44b

PT 64 follows PT 64 follows

PT 60(A)

PT 61

42a

B16C

-28-

42b

42c

B16C

-27-

1\*

2\*

3\* Published as CT VII 59e-f.

4\* Published as CT VII 58a-b.

5\* Published as CT VII 62h-i.

6\* CT 857 follows.

7\* PT 106 follows.

8\* Offering square at end of col. left blank. PT 68 follows.

9\* PT 63 follows.

10\* PT 70 follows.

11\* Published as CT VII 60n-r.

PT 64

	B16C	Sq3C
45a	(23a)- 	(97)-1* 

PT 67

	B16C	Sq3C
46b		
46c	(22)- 	
	PT 70 follows	PT 68 follows

PT 68

	B16C	Sq3C
47a	(24b)- 	(99)-2* 
47b		
(47b)		
	PT 63 follows	

PT 69

	Sq3C
48a	(105)-3* 
	PT 70 follows

PT 65

	B16C	Sq3C
45c		

PT 66

	B16C	Sq3C
46a		

PT 70

	B16C	Sq3C	Sq1S9
48b	(22)- 	(106)- 	(100)-4* 
	PT 71A follows	PT 71A follows	PT 71A follows

1\* Published as CT VII 60s-61d.

2\* Published as CT VII 61e-h.

3\* Published as CT VII 61i-k.

4\* Published as CT VII 2ki-l.

5\*

6\*

	B16C	Sq3C	Sq1Sq
*49a	-21-	-(106)- <sup>2*</sup>	-(101)- <sup>4*</sup>

	B16C	Sq3C	Sq1Sq
*49b	-20-	-(93)-	

	B16C	Sq3C	Sq1Sq
*49c	-19-		

	B16C	Sq3C	Sq1Sq
*49e	-18b-		

	B16C	Sq3C <sup>a</sup>	Sq3C <sup>b</sup>	Sq1Sq
*49f	-17d-	-(107)-	-(108)-	

1\* N 304-306+3, Nt 318-23.  
 2\* Published as CT VII 611, 59b-d, and 61m-p.  
 3\* Pyr. \*49f follows (Sq3C<sup>a</sup>).  
 4\* Published as CT VII 62m-s.  
 5\* PT 62 follows.  
 6\* Pyr. \*49f follows (Sq3C<sup>b</sup>).  
 7\* n added secondarily.

# PT 71B 1\*

	<b>B16C</b> <b>Sq1S9q</b>		<b>B16C</b> <b>Sq3C</b> <b>Sq1S9q</b>		<b>B16C</b> <b>Sq3C</b> <b>Sq1S9q</b>		<b>B16C</b>		<b>B16C</b>
*49g	-17c- -103- 2*		-16e- 3* -17a- -109- 3*	(*49i)	-16c- -16d- PT 71D follows		-16c- 4* -16b- PT 71D follows		-15b- PT 71C follows
*49h	-17b-								

# PT 71C 5\*

	<b>B16C</b>		<b>B16C</b>		<b>B16C</b>		<b>B16C</b>		<b>B16C</b>
*49n	-16a- (*49n)		-15a- 6* (*49o)		*49p 7*		*49q		*49r
									*49s
									*49t
									PT 71D follows

For notes see p. 17.

	B16C	Sq3C	Sq15q
*49u	-13e- 	-(109)- 2* 	-(105)- 3* 

	B16C	Sq3C	Sq15q
*49v	-13c- 		-106- 

	B16C	Sq3C	Sq15q
*49w	-12b- 		



	B16C	Sq3C	Sq15q
*49x			

CT 278 follows

	B16C	Sq3C
*49x	-13a- 	

PT 106 follows    PT 106 follows

1\* N 306+15-23 = Nt 283-91.  
 2\* Published as CT VII 61s-y.  
 3\* Published as CT VII 62x-dd.

Notes to p. 16:  
 1\* N 306+4-10 = Nt 324-28.  
 2\* Published as CT VII 62t-w. *r.sn* of Pyr. 91f precedes: initial *n* of *npd* perhaps omitted by haplography, or read *r.s* and *npd*.  
 3\* Published as CT VII 61q-r.  
 4\* Pyr. \*49k j.zj hr jsjrt N (Nt 326) missing.  
 5\* N 306+11-14.  
 6\* Sic, for .  
 7\* Sic, for .



PT 75-76

PT 75

PT 76

	B2Bo	Sq3C	Sq6C	T2C	T9C
51b	-7- 	- (4) - 	- (3) - 	- (3) - 	- (4) - 

	B2Bo	Sq3C	Sq6C	T2C	T9C
51c	-9- 	-5- 		-4- 	-5- 
	PT 77 follows	1*	PT 77 follows	PT 77 follows	PT 77 follows

Sq3C

1\* Text above follows, then CT 845.

(53b)  
1\*

L-X13
-6- ⋮ //
=
⋮

52a

B1Bo	B2Bo	BH3C	L1NY	L-MH1A	L-X13	M2C	M1NY	Sq1C	Sq2C	Sq3C	Sq6C	T1Be
-1- 	-11- 	-1- 	-N1- 	-N1- 	-7- 	-1- 	-5- 	-1- 	-103- 	-15- 	-5- 	-8- 







52b

--	--	--	--	--	--	--	--	--	--	--	--	--

End of col. and Head



	T4Be	T1C	T2C	T9C	T1L	TT 240
52a	<p>-1-</p> <p>-2-</p> <p>-3-</p>	<p>-246-</p> <p>4*</p>	<p>-(4)-</p> <p>5-</p> <p>4*</p> <p>6-</p>	<p>-(6)-</p> <p>7-</p>	<p>-1-</p>	<p>-66-</p> <p>-67-</p> <p>-68-</p> <p>-69-</p> <p>-70-</p> <p>-71-</p>
52b	<p>4*</p>		<p>7-</p>			<p>-72-</p> <p>-73-</p>

- 1\* See also p. 24.
- 2\* Dashed lines mark signs seen only by Maspero.
- 3\* Now lost. Maspero has □ for  and  between  and □, but only ca. 1 group lost.
- 4\* Chiselmarks—signs uncertain.
- 5\*  added secondarily.
- 6\* Scribe began to write , then altered it to .

52c

53a

B1Bo	B2Bo	BH3C	L1NY	L-MH1A	M2C	M1NY	Sq1C	Sq2C	Sq6C	T1Be	T4Be	T1C	T2C	T9C

-N4-

-N5-

13

End of col. and Head

-(6)-

-5-

-10-

-107-

-247-

2\*

3\*

T1L TT 240

52c

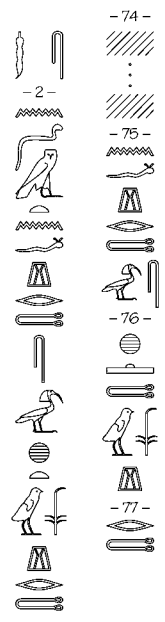

53a

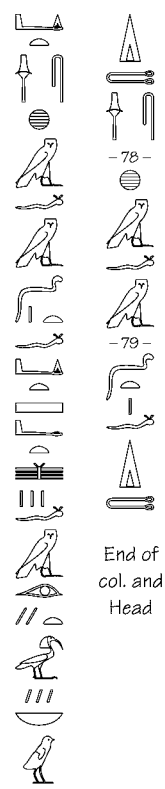

1\* Group with final reed-leaf of N.  
 2\* Lacuna of 3 groups follows to end of col. and Head. Traces at the very end may belong to the  of Pyr. 53b *sḏmtj.fj*.  
 3\* 1 group left blank.

53b

	B1Bo	B2Bo	BH3C	L1NY	L-MH1A	M2C	Sq2C	Sq6C	T1Be	T4Be	T1C	T2C	T9C	T1L
								End of col. and Head						
	PT 81 follows	PT 25 follows		PT 78 follows	PT 78 follows	PT 447 follows			PT 449 follows	PT 637 follows	CT 845 follows	PT 79 follows	PT 638 follows	PT 686 follows
(53b) 1*														
		CT 178 follows					PT 85 follows							

1\* See also p. 18.

PT 78

PT 79<sup>1\*</sup>

PT 80

	L1NY	L-MH1A
54a	-(N 8)-	-(N 6)-
	<p>CT 1040 follows</p>	<p>PT 450 follows</p>

	L1NY	L-MH1A	T2C
54c			-(10)-
	<p>CT 1040 follows</p>	<p>PT 450 follows</p>	<p>PT 81 follows</p>

	T9C <sup>a</sup>	T9C <sup>b</sup>
55a	-(16)-	-(19)-
55b		

	T9C <sup>a</sup>	T9C <sup>b</sup>
54c		
55c		

	T9C <sup>a</sup>	T9C <sup>b</sup>
55d		
	<p>PT 79 follows (T9C<sup>b</sup>)</p>	<p>CT 570 follows</p>

1\* See also PT 80 (T9C<sup>a</sup>).  
 2\* 1 group left blank.

BH4C	S5C	T1Be
-(38)- 	-(7)- 	-(43)- 

56a

B1Bo	BH4C	L-PW1A	S5C	Sq3C	T1Be	T1C	T2C	T1L
-(2)- 		-W 15- 		-(23)- 	-(44)- 	-(238)- 	-(11)- 	-(6)- 

1\* Dashed lines mark signs seen only by Passalacqua.

56b

B1Bo	BH4C	L-PW1A	S5C	Sq3C	T1Be	T1C	T2C	T1L
			PT 25 follows					
				ca. 7 1/2 groups				
						2*		

1\* Dashed lines mark signs seen only by Maspero.  
 2\* End of col. "Maspero adds ; photo not clear, but shows scarcely room" (AHG).

	B1B0	BH4C	L-PW1A	Sq3C	T1Be	T1C	T2C	T1L
56c								
57a								

1\* Ca. 8 groups lost to end of line and Foot.



	B1Bo	BH4C	L-PWIA	T1Be	T1C	T2C	T1L
57b							
57c							

	B1Bo	BH4C	T1Be	T1C	T2C	T1L
57d						
57e						
	CT 663 follows	CT 475 follows	CT 237 follows	PT 591 follows	End of col. and Head	CT 33 follows

1\*

PT 82-86

PT 82		PT 83		PT 84		PT 85		PT 86		
B2Bo		B2Bo		B2Bo		B2Bo Sq2C		B2Bo Sq2C		
58b	-475-	58c		59a	-477-	59c	-478-	-109-	59d	-479-
	-476-									
										PT 87 follows

PT 87-92

PT 87		PT 88		PT 89		PT 90		PT 91		PT 92	
B2Bo		B2Bo		B2Bo		B2Bo		B2Bo		B2Bo	
60a	-480-	60b	-481-	60b	-482-	61a	-483-	61b	-484-	61c	-485-
											PT 93 follows

1\* Last 4 signs uncertain.

# PT 93

62a	B2B0 -485-  -486-  sic  sic  -488- 	62b	B2B0 -487-  62c  -488- 	63a	B2B0 	63b	B2B0 -489-  sic  2* 	(63b)	B2B0 -490- 	63c	B2B0  -491-  PT 94 follows
-----	---	-----	---	-----	----------	-----	--	-------	-------------------	-----	--

# PT 94-96

PT 94	PT 95	PT 96
64b	64c	64d
B2B0 -492-  -493-  -494- 	B2B0 3*  -493-  sic 	B2B0 -494-  PT 108 follows

- 1\* —for pw?
- 2\* Sic—for plural strokes?
- 3\* Indistinct chisel marks—htm.

	B16C	Sq3C
69a	-11- 	-(111)- 1* 
69b		-112- 

	B16C <sup>a</sup>	B16C <sup>b</sup>	Sq3C
69c			
70a			
	-12a- 		
	-10b- 		
		3* 	
	2* 		

	B16C	Sq3C
*70b		

	B16C	Sq3C
*70c		

	B16C	Sq3C
*70d	<sup>sic</sup> 	-115- 
	PT 107 follows	PT 107 follows

1\* Published as CT VII G1z-dd.

2\* Pyr. 69c follows (B16C<sup>b</sup>).

3\* Pyr. \*70b follows.

	B16C	Sq3C	Sq6C
*71a	- (9b) -	- (115) -	2*

	B16C	Sq3C	Sq6C
*71b	- 8a -		

	B16C	Sq3C	Sq6C
*71c			

	B16C	Sq3C	Sq6C
*71d			
		PT 366 follows	PT 579 follows
*71e	- 6b -		
*71f			

\*71g

PT 643B follows

1\* Published as CT VII 58c-f.  
2\* Published as CT VII 62a-g.

PT 108

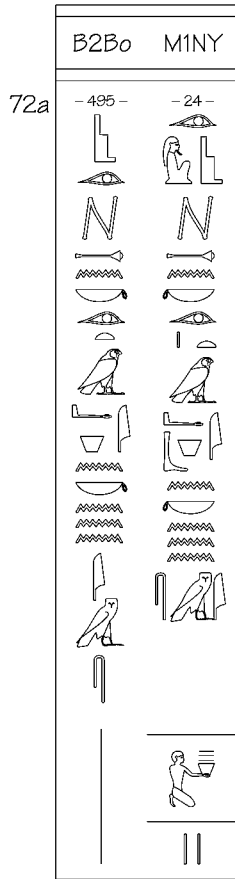

PT 109

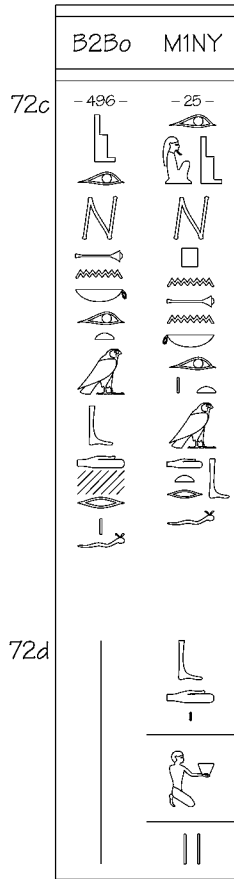

PT 110

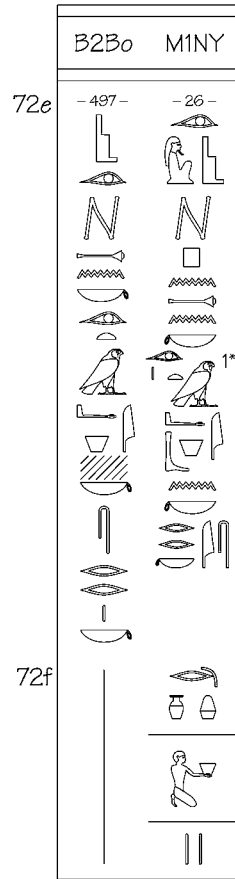

PT 111

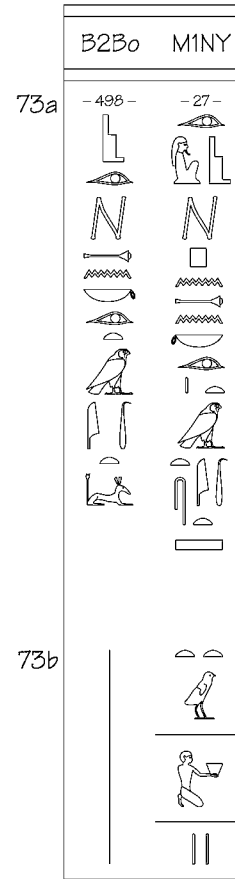

PT 112

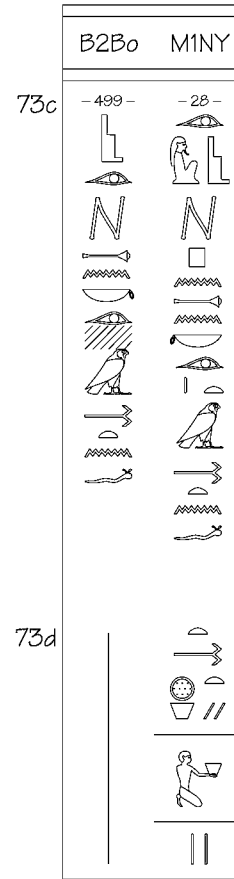

PT 113

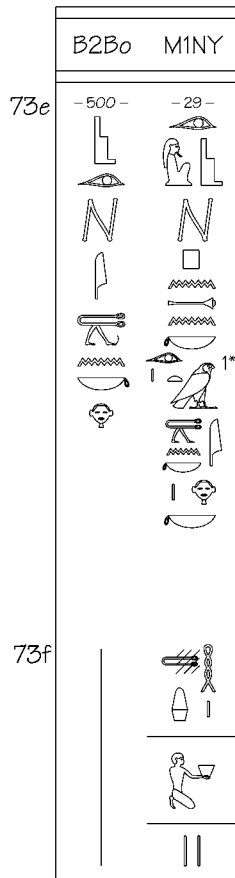

PT 114

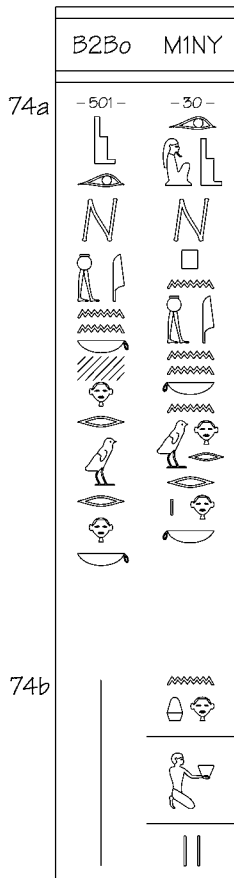

PT 115

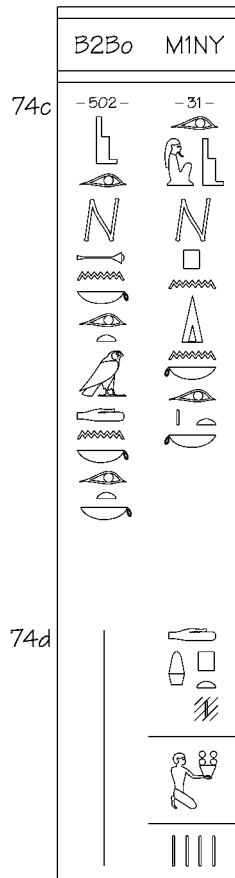

PT 116

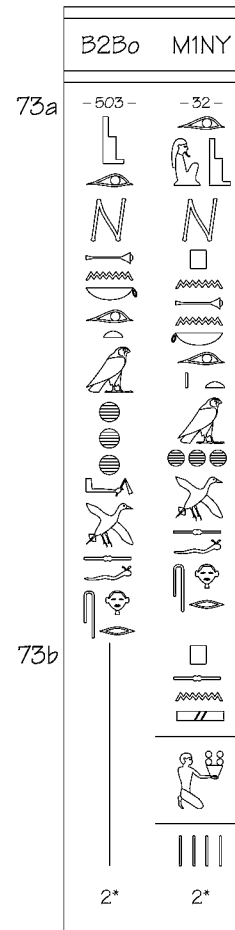

1\* jrt apparently added secondarily.  
 2\* PT 117 follows.

PT 117		PT 118		PT 119		PT 120		PT 121	
B2Bo	M1NY	B2Bo	M1NY	B2Bo	M1NY	B2Bo	M1NY	B2Bo	M1NY
75a	-504- -33-	75c	-505- -34-	76a	-507- -35-	76c	-506- -36-	77a	-37-
75b		75d		76b		76d		77b	

PT 122			PT 123		PT 124	
B2Bo <sup>a</sup>	B2Bo <sup>b</sup>	M1NY	B2Bo	M1NY	B2Bo	M1NY
77c	-508- -509-	-38-	78a	-510- -39-	78c	-511- -40-
77d			78b		78d	

- 1\* PT 120 follows.
- 2\* Group with following.
- 3\* Group with preceding.
- 4\* PT 122 follows.
- 5\* PT 119 follows.
- 6\* PT 122 substitutes.
- 7\* Ligature—possibly only .
- 8\* PT 125 follows.

	PT 125	PT 126	PT 127	PT 128	PT 129
	79a	79c	80a	80c	81a
	79b	79d	80b	80d	81b

	PT 130	PT 131	PT 132
	81c	82a	82c
	81d	82b	82d

- 1\* Group with following.
- 2\* Group with preceding.
- 3\* PT 133 follows.
- 4\* For PT 138.
- 5\* PT 139 follows.
- 6\* For PT 144.
- 7\* PT 145 follows.



PT 133

	B2Bo	M1NY
83a	-520- 	-49- 
83b	—	... 

PT 134

	B2Bo	M1NY
83c	-521- 	-50- 
83d	—	2* 

PT 135

	B2Bo	M1NY
84a	-522- 	-51- 
84b	—	... 

PT 136

	B2Bo	M1NY
84c	-523- 	-52- 
84d	—	... 

PT 137

	B2Bo	M1NY
85a	-524- 	-53- 
85b	—	

PT 138

	B2Bo	M1NY
85c	—	-54- 
85d	3* —	

PT 139

	B2Bo	M1NY
86a	-526- 	-55- 
86b	—	

PT 140

	B2Bo	M1NY
86c	-527- 	-56- 
86d	—	

PT 141

	B2Bo	M1NY
86e	-503- 	-57- 
86f	—	
4*	—	4* 

- 1\* Group with following.
- 2\* Group with preceding.
- 3\* PT 132 substitutes.
- 4\* PT 142 follows.







PT 142		PT 143		PT 144		PT 145		PT 146	
B2Bo	MINY	B2Bo	MINY	B2Bo	MINY	B2Bo	MINY	B2Bo	MINY
87a	-529- -58- 	87c	-530- -59- 	88a	-60- 	88c	-532- -61- 	89a	-533- -62- 
87b		87d		88b		88d		89b	
	1* 2* 				3* 		4* 1* 2* 		

PT 147		PT 148	
B2Bo	MINY	B2Bo	MINY
89c	-534- -63- 	90a	-535- 
89d			
	5* 6* 7* 		PT 149 follows PT 149 follows

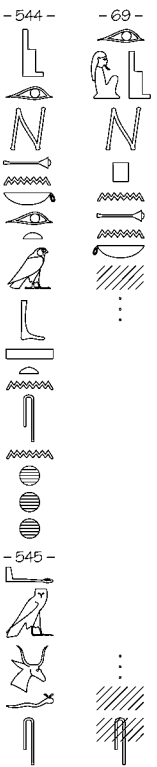
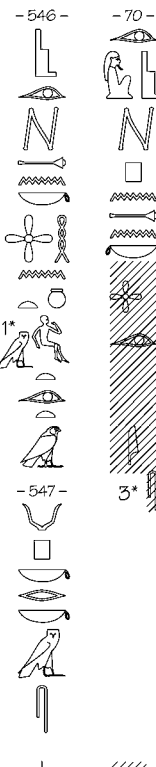
- 1\* Group with following.
- 2\* Group with preceding.
- 3\* PT 132 substitutes.
- 4\* Sign above *jm* canceled with red stroke.
- 5\* To right of following.
- 6\* To left of preceding.
- 7\* Sign to right of *s* uncertain.

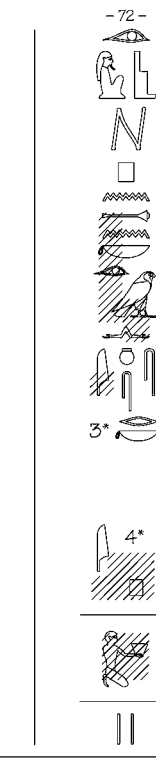
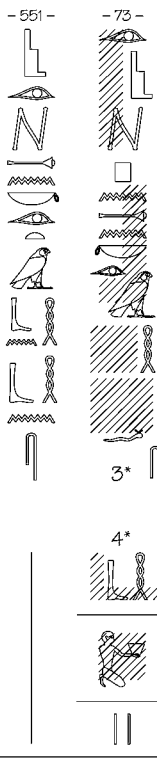
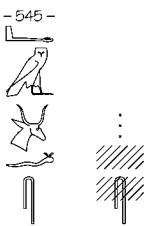
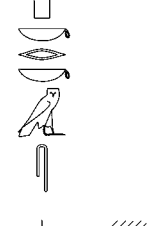
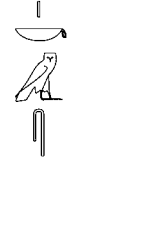
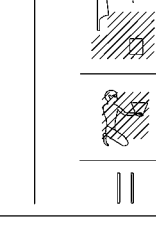
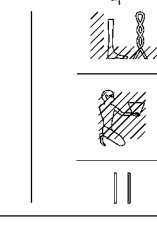
PT 149		PT 150		PT 151		PT 152		PT 153	
B2Bo	MINY	B2Bo	MINY	B2Bo	MINY	B2Bo	MINY	B2Bo	MINY
90c	-536-  -64- 	90e	-538-  -65- 	91a	-540-  -66- 	91c	-542-  -67- 	92a	-543-  -68- 
	-537-  1*		-539-  1*		-541-  1*				
90d	 2*	90f	 2*	91b	 3*			92b	 3*

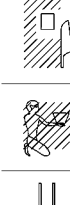

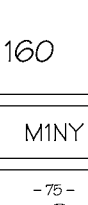
1\* Group with following.  
2\* Group with preceding.  
3\* Traces at bottom of lacuna.

PT 154		PT 155		PT 156		PT 157		PT 158	
B2Bo	MINY	B2Bo	MINY	B2Bo	MINY	B2Bo	MINY	B2Bo	MINY
92c	-544- -69- 	93a	-546- -70- 	93c	-549- -71- 	94a	-72- 	94c	-551- -73- 
	-545- 		-547- 		-550- 	94b	3* 	94d	3* 
92d		93b		93d			4* 		4* 
		2* 		5* 					

Notes to p. 41:

- 1\* Group with following.
- 2\* Group with preceding.
- 3\* To right of and below final 9 signs of PT 252.
- 4\* PT 170 follows.

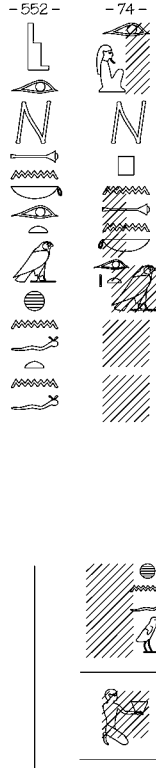
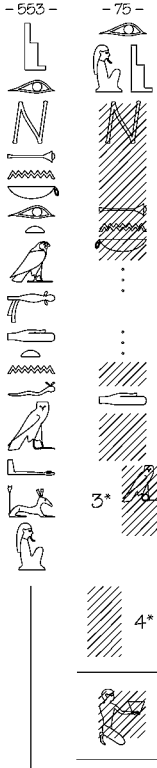
- 1\*  apparently added *secondarily*.
- 2\* PT 170 follows (for PT 157?).
- 3\* Group with following.
- 4\* Group with preceding.
- 5\* PT 158 follows.
- 6\* PT 161 follows.

PT 159		PT 160	
B2Bo	MINY	B2Bo	MINY
95a	-552- -74- 	95c	-553- -75- 
95b		95d	

PT 161

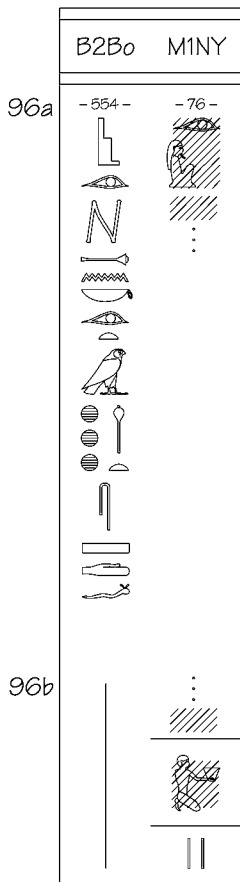

PT 162

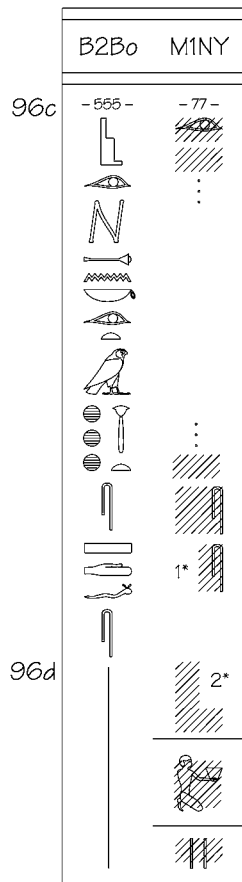

PT 163

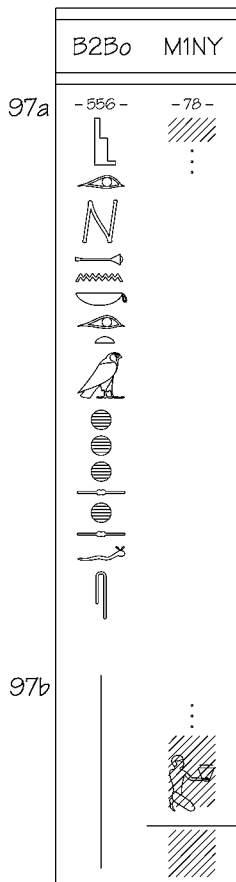

PT 164

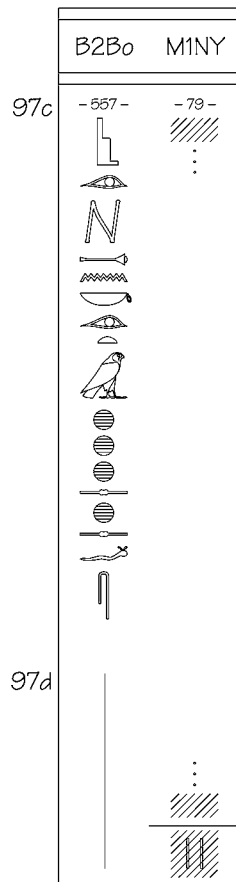

PT 165

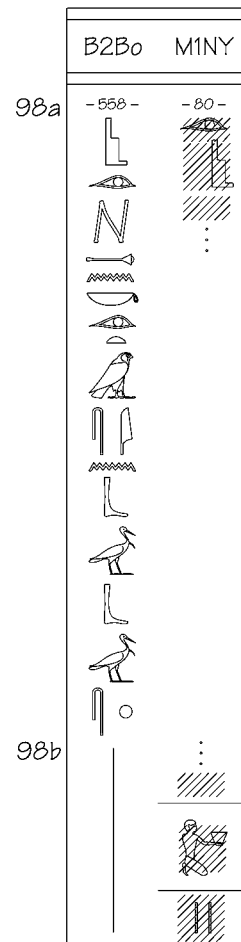

PT 166

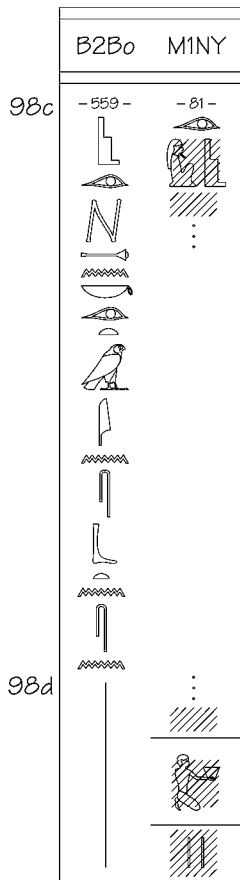

PT 167

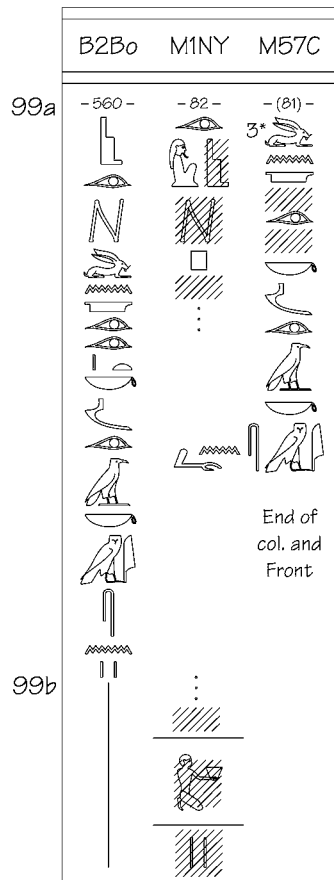

PT 168

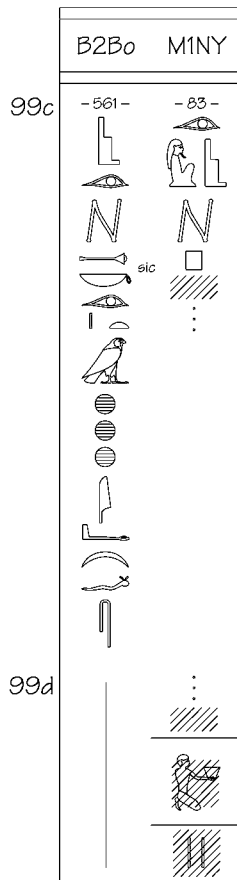

PT 169

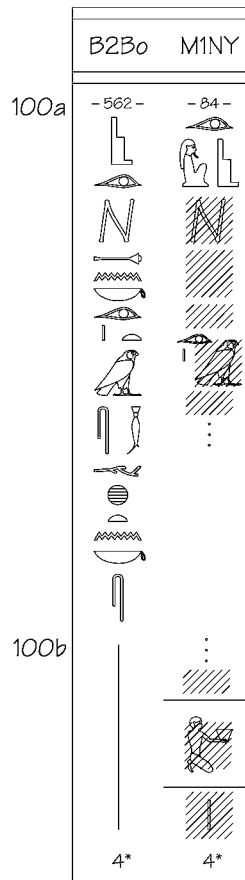

For notes see p. 40.

PT 170

PT 171

	B2Bo <sup>a</sup>	B2Bo <sup>b</sup>	MINY
100c	-548- 1* 	-563- 	-85- 
100d			4* 
	2*		

	B2Bo	MINY
100e	-564- 	-86- 
100f		5* CT 924 follows 

B2Bo
-566- 

- 1\* Between PT 155 and PT 156, for PT 157(?).
- 2\* PT 156 follows.
- 3\* Group with following.
- 4\* Group with preceding.
- 5\* Text above follows (= CT VII 127t-u), then PT 22.
- 6\* Group with first sign of N ().

PT 204

118a	L-JMH1
-E1-	

118a	L-JMH1
-E2-	
118b	

(118b)	L-JMH1
-E3-	

118c	L-JMH1
6* 	
-E4-	

119a	L-JMH1
-E5-	

119b	L-JMH1
-E6-	

(119b)	L-JMH1
PT 205 follows	

# PT 205

120a	L-JMH1	120c	L-JMH1	120d	L-JMH1	121b	L-JMH1	121d	L-JMH1	122b	L-JMH1	123b	L-JMH1	123d	L-JMH1
	-E 7-		-E 9-		-E 10-		-E 12-		-E 14-		-E 16-		-E 18-		-E 19-
120b						121c		122a		123a		123c		123e	
	-E 8-						-E 11-		-E 13-		-E 15-		-E 17-		
															PT 207 follows

# PT 207

# PT 209

124a	L-JMH1	124b	L-JMH1	124c	L-JMH1	125a	L-JMH1	125b	L-JMH1	125c	L-JMH1
	- (E 19) -						- (E 20) -				
					ca. 11 groups lost						
	- E 20 -				PT 209 follows		- E 21 -				PT 210 follows

126b L-JMH1  
 -(E 21)-  
 ...  
 -E 22-  
 ...  
 126c L-JMH1  
 ...  
 ca. 14 groups lost  
 ...  
 127b L-JMH1  
 ...  
 -E 23-  
 ...  
 127c L-JMH1  
 ...  
 127d L-JMH1  
 ...  
 ca. 13 groups lost  
 ...  
 128c L-JMH1  
 ...  
 -E 24-  
 ...  
 129a L-JMH1  
 ...  
 ca. 13 groups lost  
 ...  
 -E 25-  
 ...  
 129b L-JMH1  
 ...  
 -E 25-  
 ...  
 129c L-JMH1  
 ...  
 130a L-JMH1  
 ...  
 -E 26-  
 ...  
 130b L-JMH1  
 ...  
 -E 26-  
 ...  
 130c L-JMH1  
 ...  
 1\*

132a L-JMH1  
 -E 27-  
 ...  
 2\*  
 ...  
 132b L-JMH1  
 ...  
 ca. 10 groups lost  
 ...  
 131b L-JMH1  
 ...  
 -E 28-  
 ...  
 2\*  
 ...  
 131c L-JMH1  
 ...  
 131d L-JMH1  
 ...  
 131e L-JMH1  
 ...  
 ca. 5½ groups lost  
 ...  
 132d L-JMH1  
 ...  
 (132d) L-JMH1  
 ...  
 3\*

1\* For notes see p. 45.



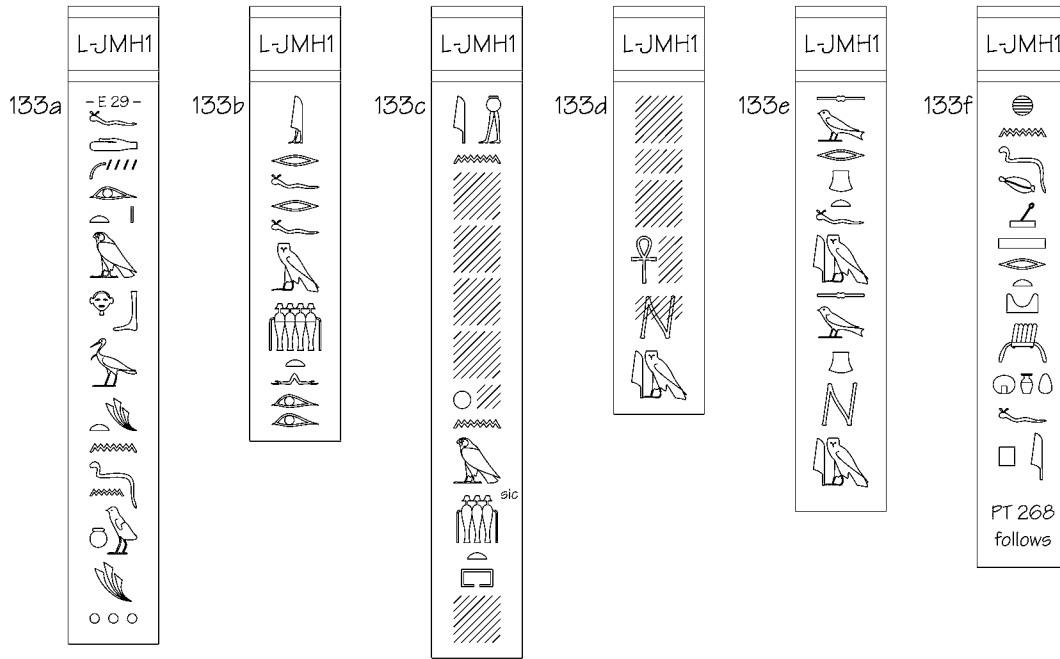

Notes to p. 44:

1\* Ca. 5 groups lost to end of col. PT 211 (Pyr. 132a) follows.

2\* Group with first sign of N (𓏲).

3\* End of col. PT 212 follows.

Ab1Le <sup>a</sup>	-22-	
Ab1Le <sup>b</sup>	-90-	
Ab2Le <sup>a</sup>	-1-	
Ab2Le <sup>b</sup>	-60-	
B4Bo	-34B-	
B6Bo	-85-	
B4C	-166(-)	
B6C	-205-	
B10C <sup>a</sup>	-108(-)	
B10C <sup>b</sup>	-150(-)	
B10C <sup>c</sup>	-300(-)	
B19C	-29-	
B1P	-(204)-	
BH1C	-1-	
BH3C	-36-	
BH20x	-1-	

134a

L-A1	-B 30-	
MIC	-29-	
S5C	-1-	

1\* Under B 31-43 (PT 213-214 beg.).  
 2\* Small signs added secondarily.  
 3\* No room for ?  
 4\* No room for ? Lacau's copy shows no .  
 5\* N is .

6\* End of col. Cols. B 32-35 largely lost, except for text at right. PT 214 follows.

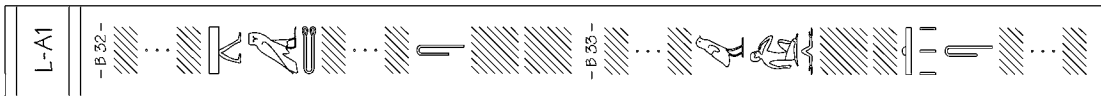

L-A1	- B 31 -	
L-JMH1	- (E 55) -	
L-D	- LD -	
M1C		
M2C	- 21 -	
M5C	- 15 -	
S5C		
Sq2Be	- 1 -	
Sq9C	- 49 -	
Sq1Cop	- 75 -	
T4Be	- 97 -	
T8C	- 1 -	
T9C	- 169 -	
T1L	- 142 -	
T1NY	- 44 -	
T240	- 19 -	
T319	- 36 -	

M2C	
M1C	
L-Nrj1	
L-JMH1	
BH20x	
BH3C	
BH1C	
B1P	
B19C	
B10C <sup>c</sup>	
B10C <sup>b</sup>	
B10C <sup>a</sup>	
B6C	
B4C	
B6Bo	
B4Bo	
Ab2Le <sup>b</sup>	
Ab2Le <sup>a</sup>	
Ab1Le <sup>b</sup>	
Ab1Le <sup>a</sup>	

M5C	S5C	Sq2Be	Sq9C	Sq1Cop	T4Be	T8C	T9C	T1L	T1NY	TT240	TT319

134b



- 1\* apparently added secondarily, for <S>.k.
- 2\* Probably nothing lost.
- 3\* 2 groups "not clear" (AdB).
- 4\* Lacau has —CTP saw only bottom of sign.
- 5\* 1 group left blank in CTP copy with note "bird" (AdB).
- 6\* 2 groups left blank for name (not inscribed).
- 7\* End of line and text.
- 8\* Col. 77 illegible on CTP photo.

M5C	
M2C	
M1C	
L-JMH1	
BH20x	
BH3C	
BH1C	
B1P	
B19C	
B10C <sup>c</sup>	
B10C <sup>b</sup>	
B10C <sup>a</sup>	
B6C	
B4C	
B6Bo	
B4Bo	
Ab2Le <sup>b</sup>	
Ab1Le <sup>b</sup>	
Ab1Le <sup>a</sup>	

134c

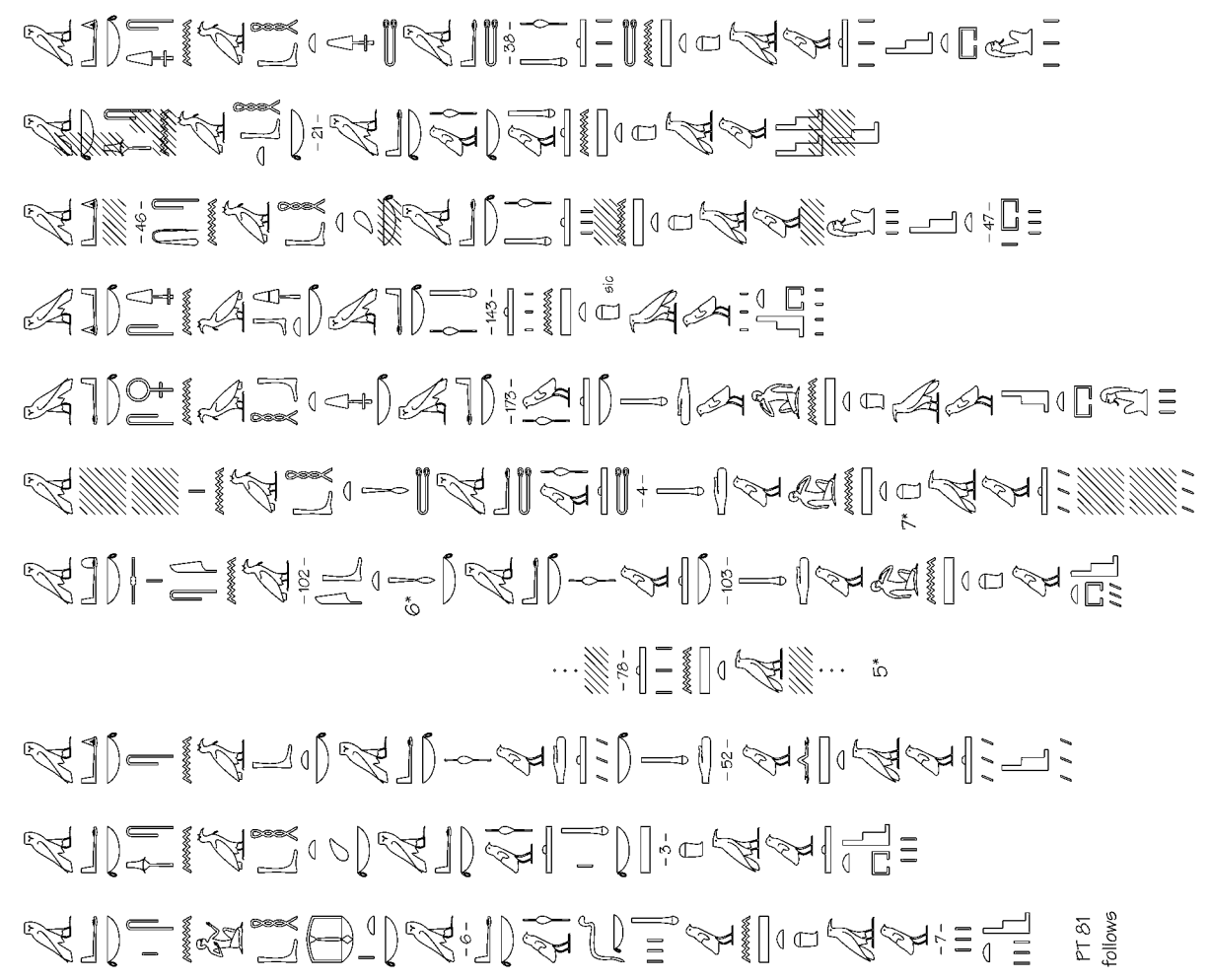
S5C Sq2Be Sq9C Sq1Cop T4Be T8C T9C T1L T1NY T1240 T1319



1\* Hieroglyphic form, added secondarily.  
 2\* Chiselmarks: | \ .  
 3\* Ca. 1½ groups lost. Pyr. 135b follows after lacuna.  
 4\*   
 5\* Rest of col. 78 and cols. 79-80 illegible on CTP photo. Pyr. 135c follows after lacuna.  
 6\*   
 7\* 

134c

PT 81 follows

135a

Ab1Le <sup>a</sup>	Ab1Le <sup>b</sup>	Ab2Le <sup>a</sup>	Ab2Le <sup>b</sup>	B4Bo	B6Bo	B4C	B6C	B10C <sup>a</sup>	B10C <sup>b</sup>	B10C <sup>c</sup>	B19C	B1P	BH1C	BH3C

-32-

-25-

2\*

-30-

...

-33-



135a

BH20x	M1C	M2C	M5C	Sq2Be	Sq9C	T4Be	T8C	T9C	T1L	T1NY	TT240	TT319
		3* 										
		4* 										

M2C

1\* Correction, over (?)  
 2\* 1½ groups erased?  
 3\* See text at right.  
 4\* Text above intervenes.

Ab1Le <sup>a</sup>	Ab1Le <sup>b</sup>	Ab2Le <sup>a</sup>	Ab2Le <sup>b</sup>	B4Bo	B6Bo	B4C	B6C	B10C <sup>a</sup>	B10C <sup>b</sup>	B10C <sup>c</sup>	B19C	B1P	BH1C	BH3C
--------------------	--------------------	--------------------	--------------------	------	------	-----	-----	-------------------	-------------------	-------------------	------	-----	------	------

(135a)

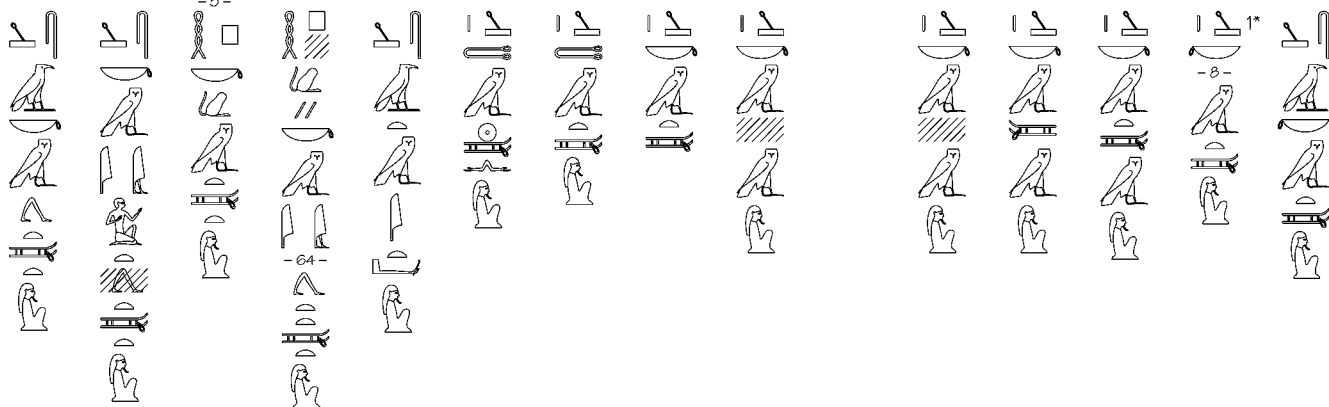

135b



For notes see p. 56.

BH20x L-JMH1 M1C M2C M5C Sq2Be Sq9C T4Be T8C T9C T1L T1NY TT240 TT319

(135a)



135b

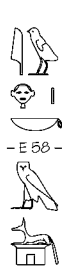

For notes see p. 56.

	Ab1Le <sup>a</sup>	Ab1Le <sup>b</sup>	Ab2Le <sup>a</sup>	Ab2Le <sup>b</sup>	B4Bo	B6Bo	B6C	B10C <sup>a</sup>	B10C <sup>b</sup>	B10C <sup>c</sup>	B19C	B1P	BH1C	BH3C	BH20x
135c															
	PT 214 follows	PT 214 follows	PT 214 follows	PT 214 follows	PT 214 follows	PT 214 follows		PT 214 follows	PT 214 follows	PT 214 follows	PT 214 follows	PT 214 follows	PT 214 follows	PT 214 follows	PT 214 follows

Notes to pp. 54–55:

1\*

2\* Chiselmarks: // /.

3\* Ca. 25 groups lost. PT 214 follows.

4\* —apparently malformed from lack of space at end of col. Sign repeated at top of col. 6.

	L-JMH1	M1C	M2C	M5C	Sq2Be	Sq9C	Sq1Cop	T4Be	T8C	T9C	T1L	T1NY	TT240	TT319
135c														
	PT 214 follows	PT 214 follows	PT 214 follows	PT 214 follows	PT 214 follows	PT 214 follows	PT 214 follows	PT 214 follows	PT 214 follows	PT 214 follows	PT 214 follows	PT 214 follows	PT 214 follows	PT 214 follows

1\* Ca. 6½ groups lost. PT 214 follows.  
 2\* See p. 51 n. 5\*.

Ab1Le <sup>a</sup>	- (26) -		
Ab1Le <sup>b</sup>	- (94) -		
Ab2Le <sup>a</sup>	- (7) -		
Ab2Le <sup>b</sup>	- (65) -		
B4Bo	- (351) -		
B6Bo	- (32) -		
B4C	- (166) -		
B6C	- (207) -		
B10C <sup>a</sup>	- (109) -		
B10C <sup>b</sup>	- (132) -		
B10C <sup>c</sup>	- (301) -		
B19C	- (24) -		
B1P	- (207) -		
B1C	- (10) -		
BH3C	- (40) -		
BH20x	- (11) -		
L-A1 <sup>a</sup>	- (636) -		

136a

136b

Sq2Be	- (4) -	
L-A1	- B 44 -	

TINY	
------	--

- 1\* Under B 45-57 (PT 214 end-215 beginning). See also p. 46 n. 1.  
 2\*  $\frac{1}{2}$  group left blank.  
 3\* Chiselmarks:  $\text{|||||} = \text{A} ?$   
 4\* Or   
 5\* End of col. and section.  
 6\* Corrected out of   
 7\* added secondarily.  
 8\* Text above intervenes before remainder of Pyr. 136b (= zp 2 of other copies).

L-JMH1	- (E 59) -		136a
M1C	- (35) -		
M2C	- (27) -		
M5C	- (20) -		
Sq2Be			
Sq9C	- (54) -		
Sq1Cop	- (92) -		
T4Be	- 11 -		
T8C	- (7) -		
T9C	- (177) -		
T1L	- (144) -		
T1NY	- (50) -		
TT240	- (23) -		
TT319	- (40) -		
		<p>ca. 5 groups lost</p>	136b

Ab1Le <sup>a</sup>	Ab1Le <sup>b</sup>	Ab2Le <sup>a</sup>	Ab2Le <sup>b</sup>	B4Bo	B6Bo	B4C	B6C	B10C <sup>a</sup>	B10C <sup>b</sup>	B10C <sup>c</sup>	B19C	B1P	BH1C	BH3C	BH20x	L-A1 <sup>a</sup>	L-JMH1	M1C	M2C

(136b)



M5C	Sq2Be	Sq9C	T4Be	T8C	T9C	T1L	T1NY	TT240	TT319

(136b)

1\* Corrected out of

2\* "Looks so, but lacuna is small for " (CTP).

3\* Group corrected over .

Ab1Le <sup>a</sup>			
Ab1Le <sup>b</sup>			
Ab2Le <sup>a</sup>			
Ab2Le <sup>b</sup>		ca. 7 groups lost	
B4Bo		353-	
B6Bo		2	
B4C		169-	
B6C			
B10C <sup>a</sup>			
B10C <sup>b</sup>			
B10C <sup>c</sup>			
B19C			
B1P			
BH1C		3*	
BH3C			
BH20X			
L-A1 <sup>a</sup>			
L-A1 <sup>b</sup>		4*	
L-JMH1			
MIC		57-	

137a

4721

ca. 9 groups lost

15-

4\*

-(539)-

3\*

169-

2

ca. 7 groups lost

353-

5\*



...

96-

M2C	M5C	Sq2Be	Sq9C	T4Be	T8C	T9C	T1L	T1NY	TT24O	TT319

137a

137b

1\* Fyr. 138b follows (pp. 68-69).  
 2\* Corrected out of .  
 3\*  added secondarily.  
 4\* Fyr. 138c precedes (L-A1<sup>a</sup>).  
 5\* Ca. 26 groups lost. Fyr. 137d follows.

Ab1Le <sup>a</sup>	Ab1Le <sup>b</sup>	Ab2Le <sup>a</sup>	Ab2Le <sup>b</sup>	B4Bo	B6Bo	B10C <sup>a</sup>	B10C <sup>b</sup>	B10C <sup>c</sup>	B19C	B1P	BHIC	BH3C	BH20x	L-A1 <sup>a</sup>	L-A1 <sup>b</sup>	L-JMH1	M1C
		<sup>-10-</sup> ca. 6 groups lost	<sup>-66-</sup>		ca. 6½ groups lost		ca. 5 groups lost										
		<p>(137b) <span style="float: right;">137c-d</span></p>															

M2C	M5C	Sq2Be	Sq9C	T4Be	T8C	T9C	T1L	T1NY	TT240	TT319

(137b)

137c-d

1\* Corrected over plural strokes.  
 2\*  
3\* Corrected from .  
4\* Probably nothing else at end of col.  
5\* Pyr: 138c follows.

Ab1Le<sup>a</sup> Ab1Le<sup>b</sup> Ab2Le<sup>a</sup> Ab2Le<sup>b</sup> B4Bo B6Bo B4C B6C B10C<sup>a</sup> B10C<sup>b</sup> B10C<sup>c</sup> B1P BH1C BH3C BH20x

(137d)

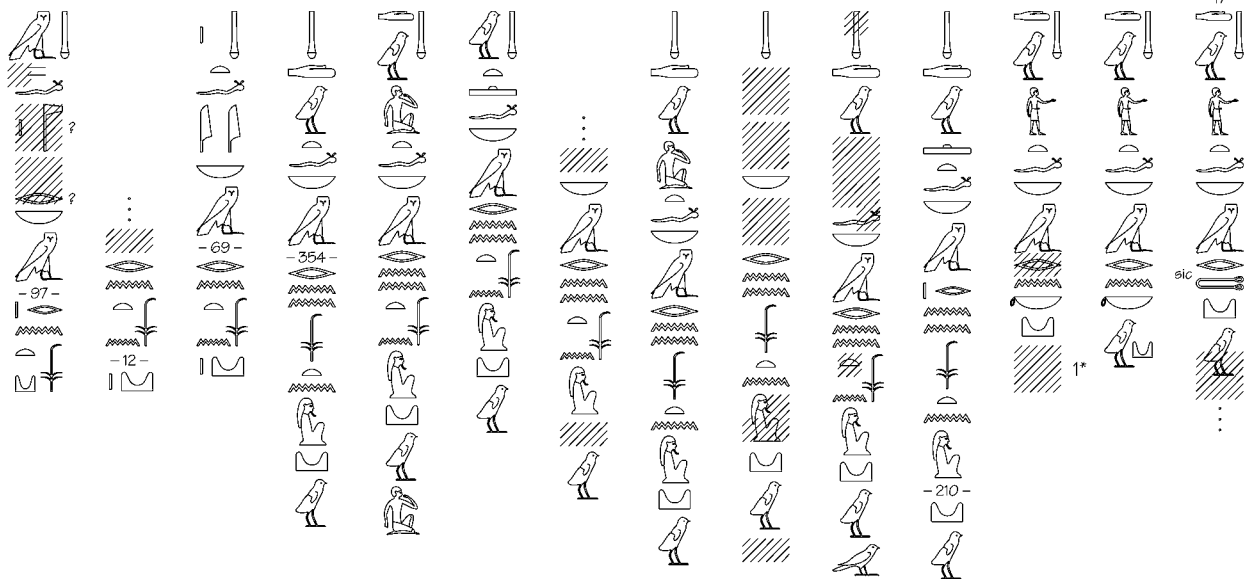

138a

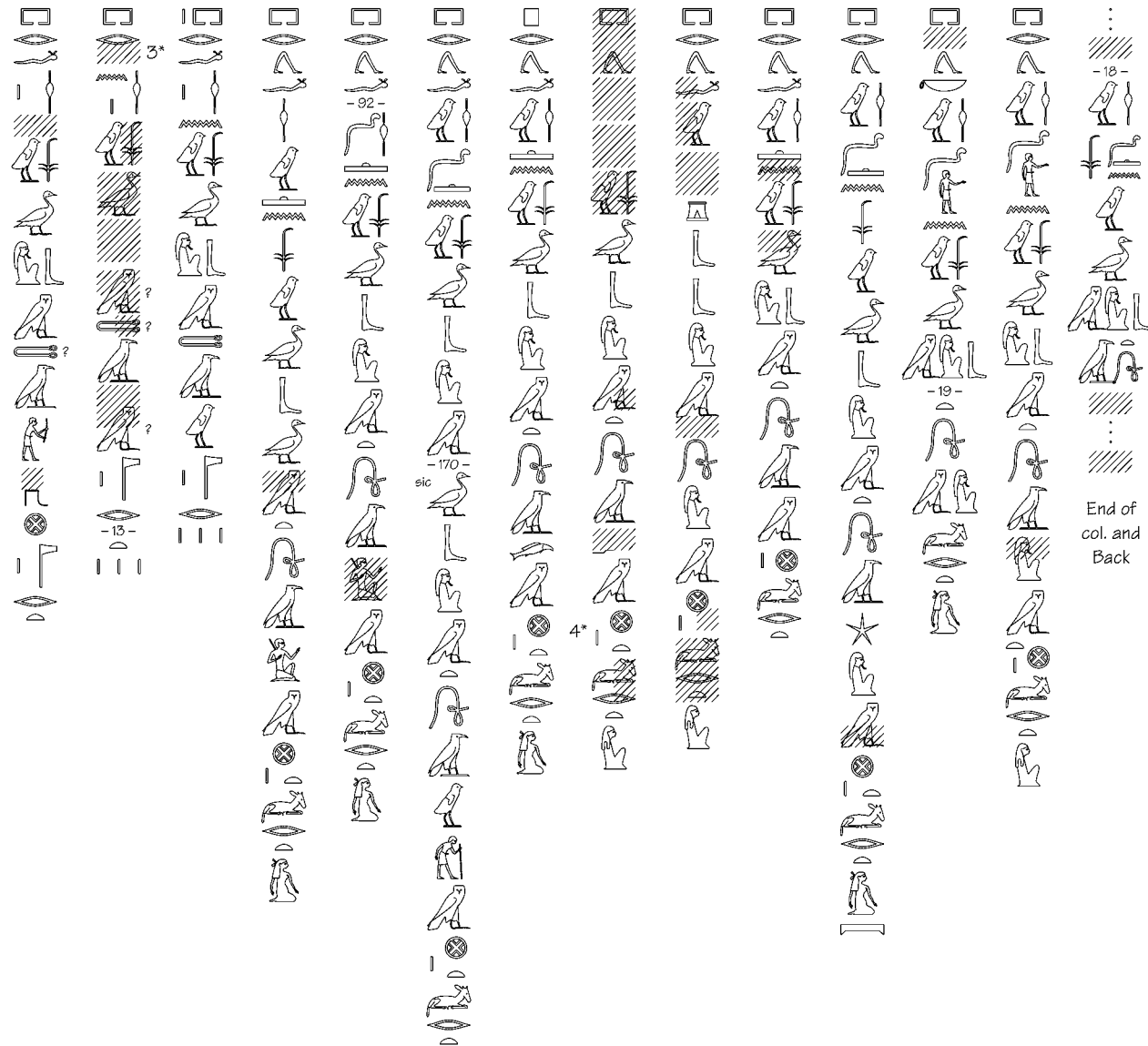

End of col. and Back







L-A1<sup>b</sup> L-JMH1 M1C M2C M5C M25C Sq2Be Sq9C T4Be T8C T8C T1L T1NY TT240 TT319

138b

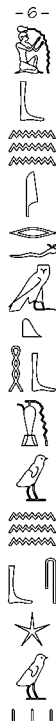
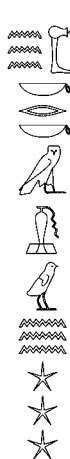

End of col. and Front



138c

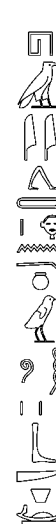
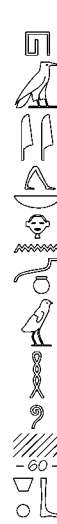
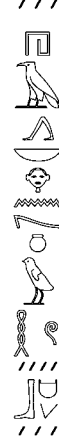

1\* Corrected from

2\* Chiselmarks: read perhaps —cf. TT319.

3\* Pyr. 137a follows (L-A1<sup>b</sup>).

4\* Beginning of frag. R.

(138c)

Ab1Le <sup>a</sup>	Ab1Le <sup>b</sup>	Ab2Le <sup>a</sup>	Ab2Le <sup>b</sup>	B4Bo	B6Bo	B4C	B6C	B10C <sup>a</sup>	B10C <sup>b</sup>	B10C <sup>c</sup>	B1P	BH1C	BH3C	L-A1 <sup>b</sup>

End of col. and Back

139a

--	--	--	--	--	--	--	--	--	--	--	--	--	--	--

Notes to pp. 66-67:

- 1\* Perhaps nothing lost.
- 2\* ∫ corrected from ∫.
- 3\* Apparently not enough room for ∫.
- 4\* Chiselmarks
- 5\* Hieroglyphic sign.
- 6\* Pyr. 138c follows after lacuna.

L-JMH1 M1C M2C M5C M25C Sq2Be Sq9C T8C T9C T1L T1NY TT240 TT319

(138c)

--	--	--	--	--	--	--	--	--	--	--	--	--

139a

--	--	--	--	--	--	--	--	--	--	--	--	--

1\* Corrected from //, or vice-versa.  
 2\* Or —.—.  
 3\* Perhaps nothing lost.  
 4\* Corrected to —.—?  
 5\* Entire col. lost. Pyr. 139b end follows after lacuna.

Ab1Le<sup>a</sup> Ab1Le<sup>b</sup> Ab2Le<sup>a</sup> Ab2Le<sup>b</sup> B4Bo B6Bo B4C B6C B10C<sup>a</sup> B10C<sup>b</sup> B10C<sup>c</sup> B1P BH3C L-A1<sup>b</sup> L-JMH1

(139a)

-30-

PT 219  
(Pyr. 167b)  
follows

ca. 26  
groups  
lost

-94-

-B43-

139b

-210-

-111-

1\*

2\*

3\*

4\*

5\*

6\*

7\*

-100-

-72-

-46-

-E61-

- 1\* Or .
- 2\* Corrected out of .
- 3\* Chiselmarks.
- 4\* Over an erased sign.
- 5\* Hieroglyphic sign.
- 6\* .
- 7\* added secondarily.

M1C M2C M5C M25C Sq2Be Sq9C T8C T9C T1L T1NY TT240 TT319

(138c)

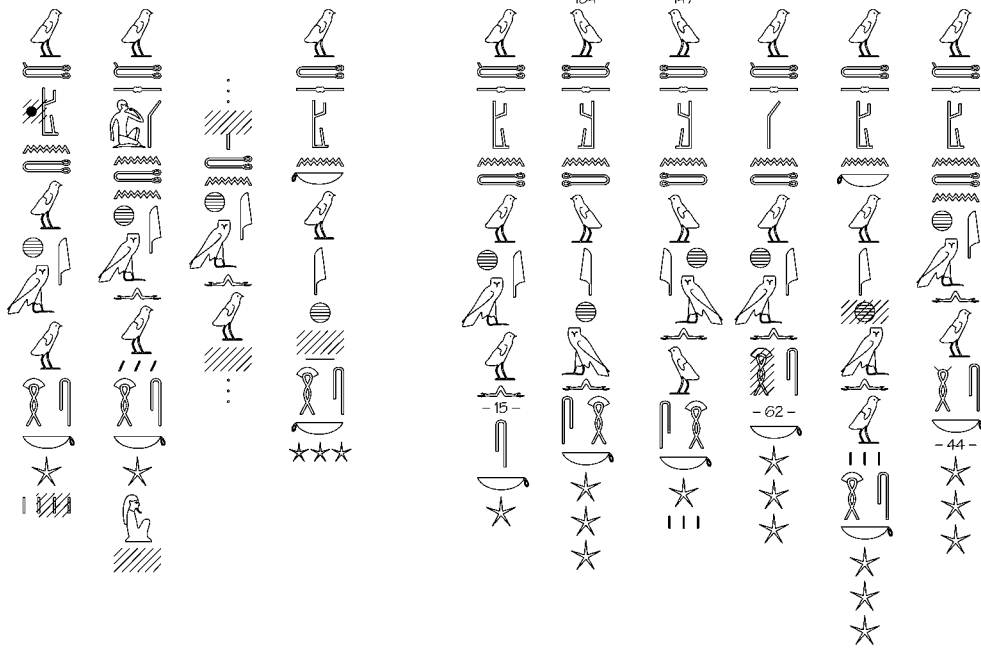

139b



139c



























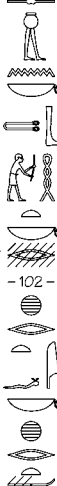

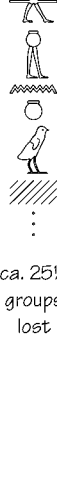









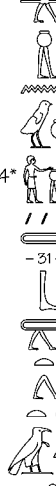





Ab1Le <sup>a</sup>	Ab1Le <sup>b</sup>	Ab2Le <sup>b</sup>	B4Bo	B6Bo	B4C	B6C	B10C <sup>a</sup>	B10C <sup>b</sup>	B10C <sup>c</sup>	B1P	BH3C	L-A1 <sup>b</sup>	L-JMH1	M1C

139a

--	--	--	--	--	--	--	--	--	--	--	--	--	--	--

PT 215 follows   PT 215 follows   PT 215 follows   PT 215 follows   PT 215 follows   PT 215 follows   PT 215 follows   PT 215 follows   PT 215 follows   PT 215 follows   PT 215 follows   PT 215 follows   PT 215 follows   End of col. and East wall   PT 215 follows



	Ab1Le <sup>a</sup>	Ab1Le <sup>b</sup>	B4Bo	B6Bo	B4C	B6C	B10C <sup>a</sup>	B10C <sup>b</sup>	B10C <sup>c</sup>	B1P	BH3C	L-A1	M1C	M2C	M5C
140a															
140b															
140c															

ca. 25 1/2 groups lost

End of col. and Back



	M25C	Sq9C	T8C	T9C	T1L	T1NY	TT240	TT319
140a	-(18)-	-(60)- 		-(188)- 	-(147)- 	-(64)- 	-(34)- 	
140b					-(148)- 	-(65)- 		
140c								-(47)- 

	B10C <sup>a</sup>	B10C <sup>c</sup>
212a		
212b		

1\* Sign made like 3 rather than *tjw*.  
 2\* Text above (= Pyr. 212a-b) follows before Pyr. 140c.  
 3\* "Form like *Hrw*—apparently *tjw*" (AdB).  
 4\* —right part like preceding ; cf. also T1L.

Ab1Le<sup>a</sup> Ab1Le<sup>b</sup> B4Bo B6Bo B4C B6C B10C<sup>a</sup> B10C<sup>b</sup> B10C<sup>c</sup> BH3C L-A1 M1C M2C M5C M25C

(140c)

-20-

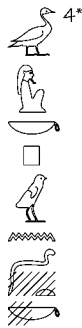
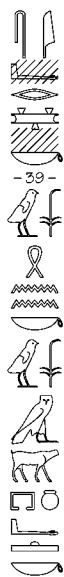
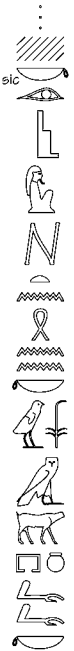
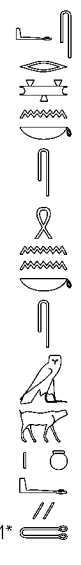
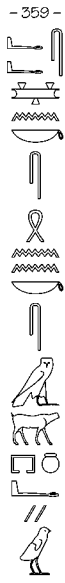

Sq2Be Sq9C T8C T9C T1L T1NY TT240 TT319

(140c)

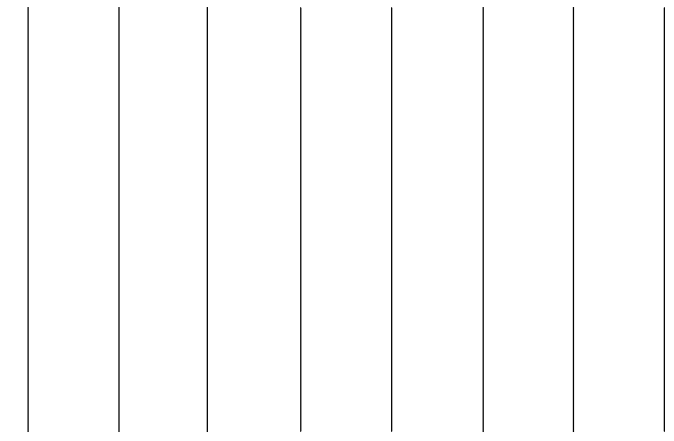

-9-  
ca. 16 groups lost

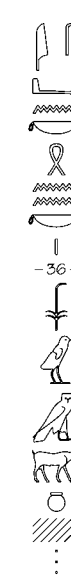
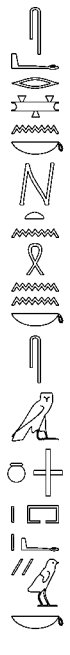

4\*  
sic

1\* Corrected from .  
2\* Chiselmarks.  
3\* = Pyr. 160a beginning.  
4\* = Pyr. 160c.

141a

Ab1Le <sup>a</sup>	Ab1Le <sup>b</sup>	B4Bo	B6Bo	B4C	B6C	B10C <sup>a</sup>	B10C <sup>b</sup>	B10C <sup>c</sup>	B19C	BH3C	L-A1	M1C	M2C	M5C

141b

--	--	--	--	--	--	--	--	--	--	--	--	--	--	--

ca. 25 1/2 groups lost

-34-

-34-

-34-

-34-

-34-

-34-

-34-

-34-

-34-

-34-

-34-

-34-

-34-

-34-

-34-

-34-

-34-

-34-

-34-

-34-

-34-

-34-

-34-

-34-

-34-

-34-

-34-

-34-

-34-

-34-

-34-

-34-

-34-

-34-

-34-

-34-

-34-

-34-

-34-

-34-

-34-

-34-

-34-

-34-

-34-

-34-

-34-

-34-

-34-

-34-

-34-

-34-

-34-

-34-

-34-

-34-

-34-

-34-

-34-

-34-

-34-

-34-

-34-

-34-

-34-

-34-

-34-

-34-

-34-

-34-

-34-

-34-

-34-

-34-

-34-

-34-

-34-

-34-

-34-

-34-

-34-

-34-

-34-

-34-

-34-

-34-

-34-

-34-

-34-

-34-

-34-

-34-

-34-

-34-

-34-

-34-

-34-

-34-

-34-

-34-

-34-

-34-

-34-

-34-

-34-

-34-

-34-

-34-

-34-

-34-

-34-

-34-

-34-

-34-

-34-

-34-

-34-

-34-

-34-

-34-

-34-

-34-

-34-

-34-

-34-

-34-

-34-

-34-

-34-

-34-

-34-

-34-

-34-

-34-

-34-

-34-

-34-

-34-

-34-

-34-

-34-

-34-

-34-

-34-

-34-

-34-

-34-

-34-

-34-

-34-

-34-

-34-

-34-

-34-

-34-

-34-

-34-

-34-

-34-

-34-

-34-

-34-

-34-

-34-

-34-

-34-

M25C Sq2Be Sq9C T8C T9C T1L T1NY TT240 TT319

141a

-21-

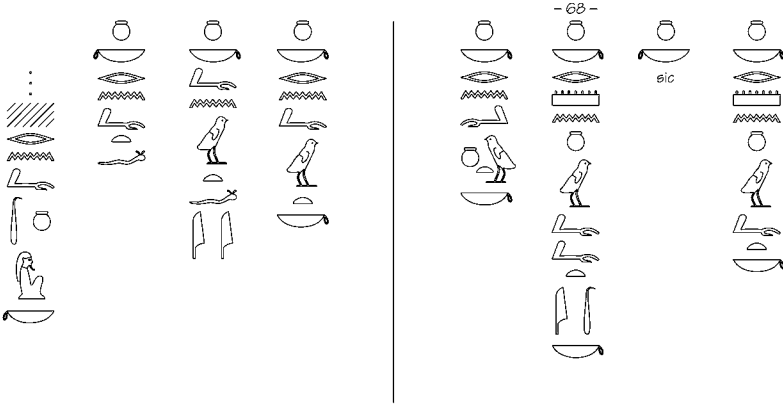

141b

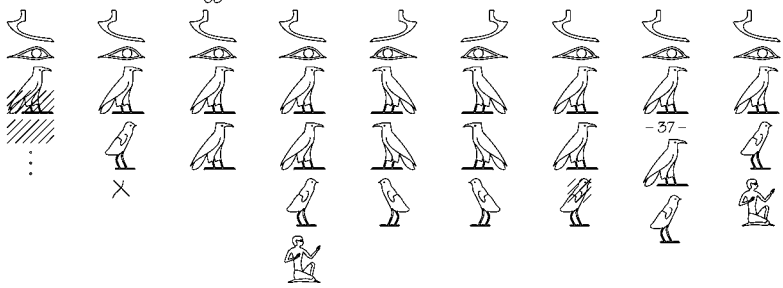

Ab1Le <sup>a</sup>	Ab1Le <sup>b</sup>	Ab2Le	B4Bo	B6Bo	B4C	B6C	B10C <sup>a</sup>	B10C <sup>b</sup>	B10C <sup>c</sup>	B19C	BH3C	L-A1	M1C	M2C
--------------------	--------------------	-------	------	------	-----	-----	-------------------	-------------------	-------------------	------	------	------	-----	-----

(141b)

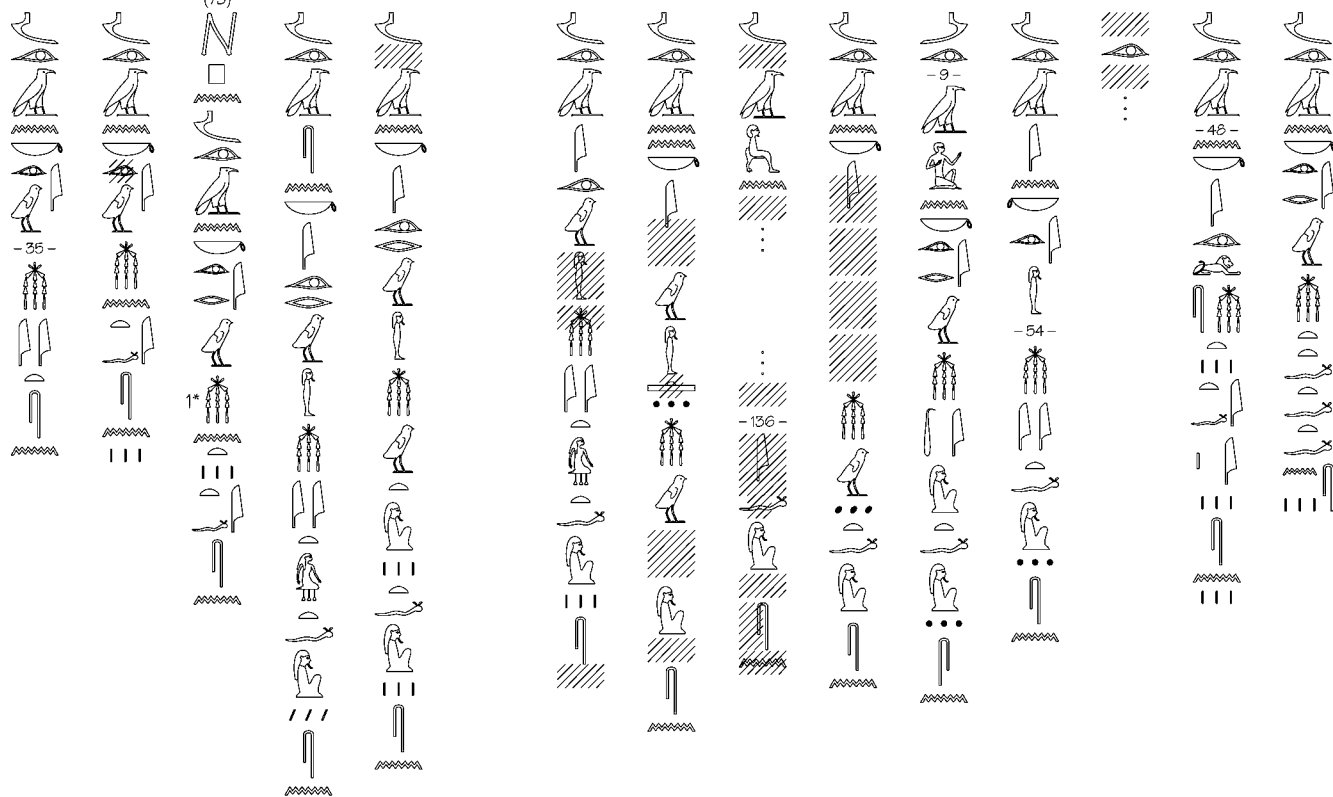

141c

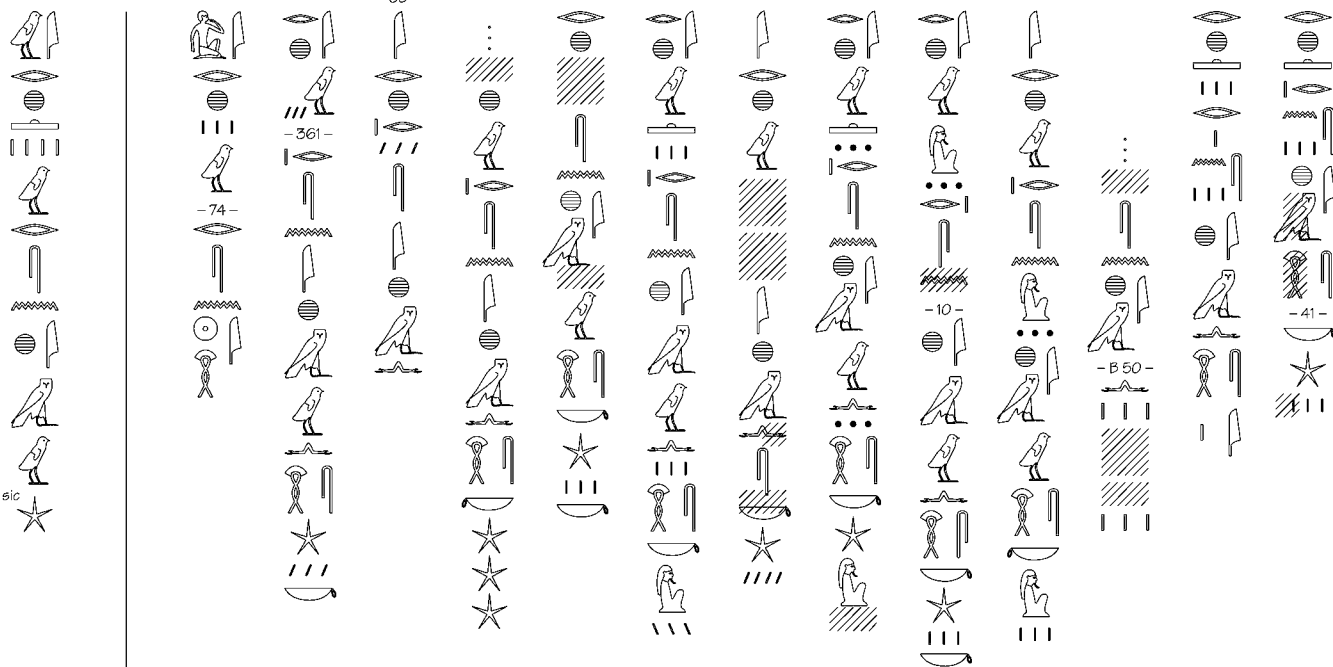

M5C M25C Sq2Be Sq9C T8C T9C T1L T1NY TT240 TT319

(141b)

- 22 -

--	--	--	--	--	--	--	--	--	--

141c

--	--	--	--	--	--	--	--	--	--

1\* Like , but with extra tick at top.

2\* End of col. and register i.  
PT 220 follows in register ii.

	Ab1Le <sup>a</sup>	Ab1Le <sup>b</sup>	Ab2Le	B4Bo	B6Bo	B4C	B6C	B10C <sup>a</sup>	B10C <sup>b</sup>	B10C <sup>c</sup>	B19C	BH3C	L-A1	M1C	M2C
141d															
142a															

-36-

?

sic

1\*

-55-

...

-49-

-105-

2\*

?

-75-

-362-

-99-

ca. 26 groups lost

-213-

-11-

-56-

-B 51-

-50-

-42-

3\*



	M5C	M25C	Sq9C	T8C	T9C	T1L	T1NY	TT240	TT319
141d									
142a									

143b

M1C

1\* Chiselmarks.  
 2\* Or   
 3\* Text above intervenes before Pyr. 142b.

	Ab1Le <sup>a</sup>	Ab1Le <sup>b</sup>	Ab2Le	B4Bo	B6Bo	B4C	B6C	B10C <sup>a</sup>	B10C <sup>b</sup>	B10C <sup>c</sup>	B19C	BH3C	L-A1	M1C	M2C
142b													—		
142c														—	
143a					—			—	—	—		—		—	

	M5C	M25C	R1X	Sq9C	T8C	T9C	T1L	T1NY	TT240	TT319
142b		-23- 	-62- 							
142c				-66- 		-197- 				
143a										

	M1C	M2C	M5C
143b	-52- 	-43- 	

- 1\* Determinative presumably added *secondarily*.
- 2\*
- 3\* Dashed lines mark signs seen only by Lacau.
- 4\* Text above follows, then Pyr. 144a.
- 5\* Text above intervenes before Pyr. 142c.
- 6\* Text above precedes.
- 7\* 2/3 line lost, not enough for Pyr. 143. Pyr. 144b follows after lacuna.
- 8\* Ca. 2 1/2 groups lost. N follows at end of col. 66 and beginning of col. 67. Remainder of col. 67 lost; end of register and Bottom.
- 9\* Text above follows (from Pyr. 144a) before remainder of Pyr. 143a.

Ab1Le<sup>a</sup> Ab1Le<sup>b</sup> Ab2Le B4Bo B6Bo B4C B6C B10C<sup>a</sup> B10C<sup>b</sup> B10C<sup>c</sup> B19C BH3C L-A1 M1C M2C

(143a)

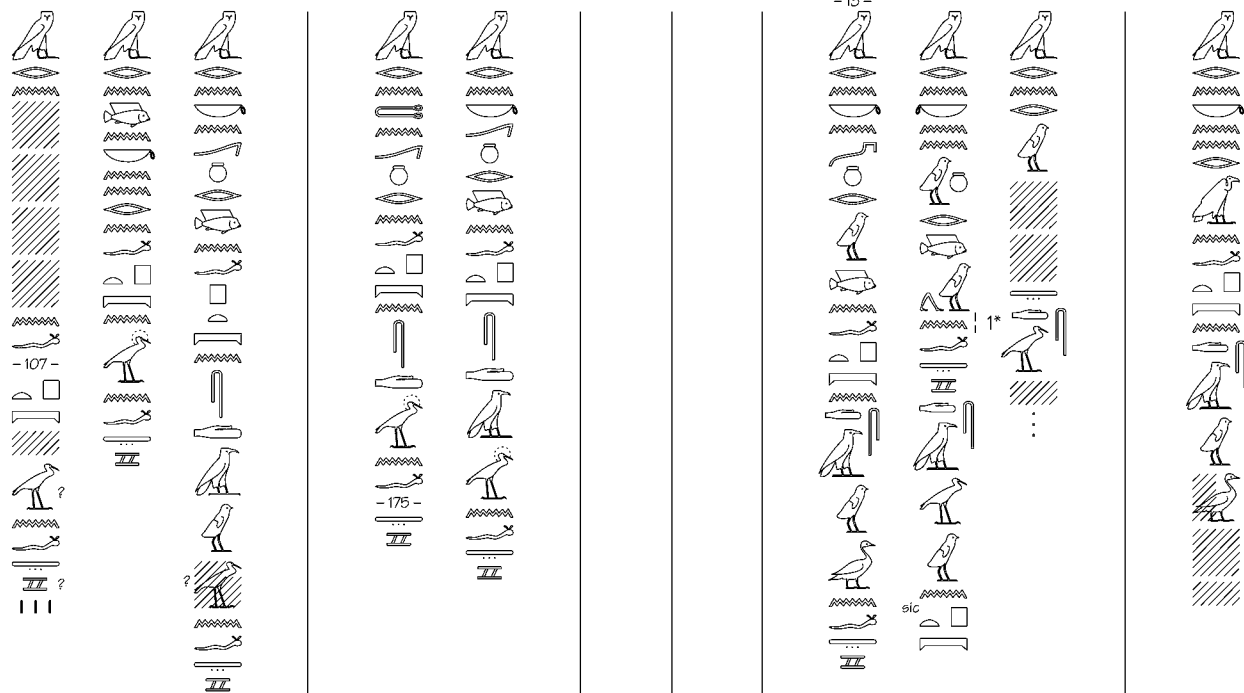

143b

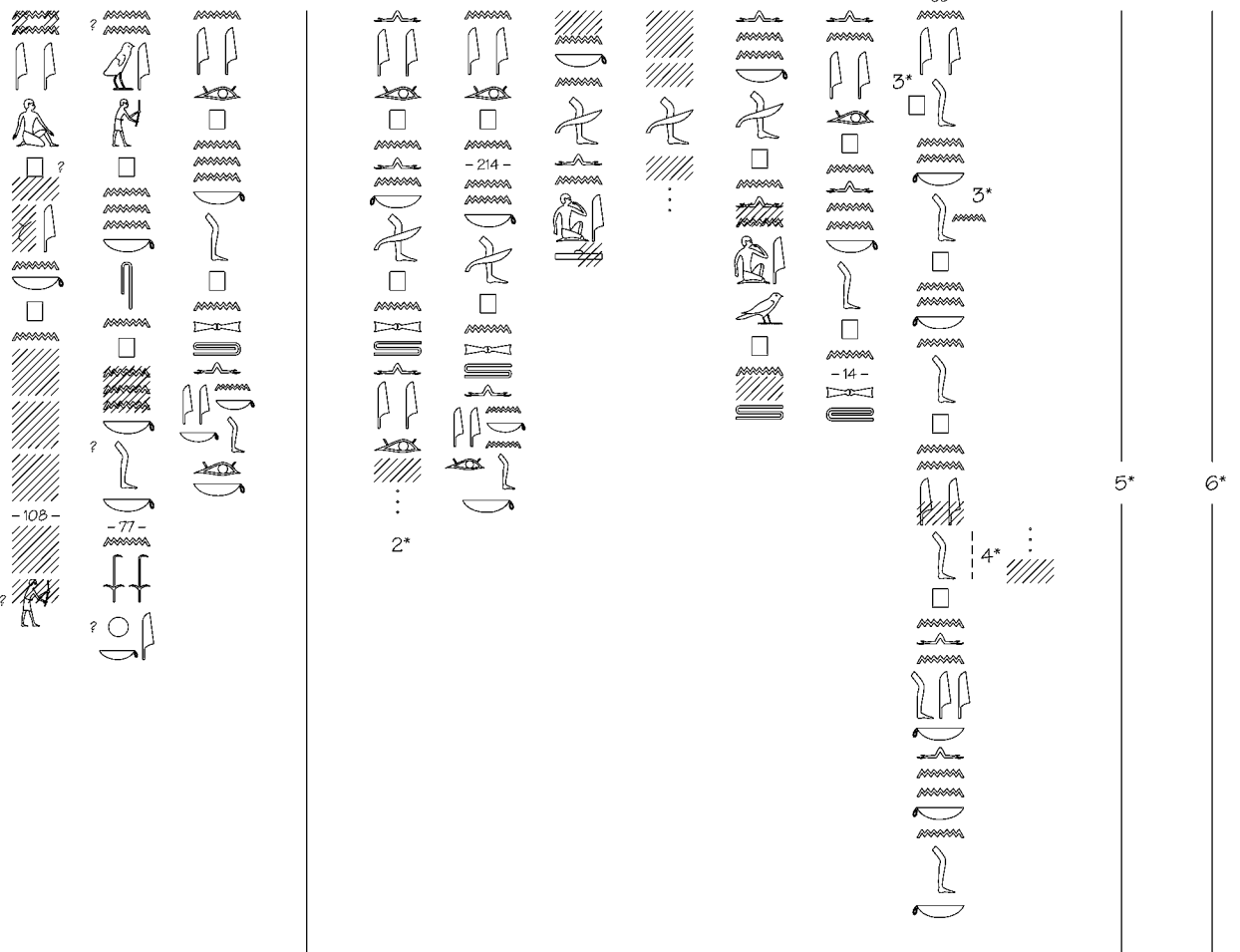

	M5C	M25C	R1X	T8C	T9C	T1L	T1NY	TT240	TT319
(143a)	<p>-37-</p> <p>ca. 4 groups lost</p>			<p>-74-</p> <p>-198-</p> <p>-24-</p>			<p>-74-</p>	<p>-53-</p>	
143b	<p>7*</p>			<p>-25-</p>	<p>-199-</p>		<p>-75-</p> <p>-42-</p>	<p>-54-</p>	

1\* See p. 87 n. 3  
 2\* Ca. 25½ groups lost. Pyr. 144b follows after lacuna.  
 3\* □ and ~~~~~ added secondarily.  
 4\* So Lacau. If so, much shorter than preceding examples.  
 5\* See p. 87 n. 3 and p. 89 n. 4.  
 6\* See p. 87 n. 5.  
 7\* See p. 93 n. 3.

Ab1Le<sup>a</sup> Ab1Le<sup>b</sup> Ab2Le B4Bo B6Bo B4C B6C B10C<sup>a</sup> B10C<sup>b</sup> B10C<sup>c</sup> B19C BH3C L-A1 M1C M2C

144a

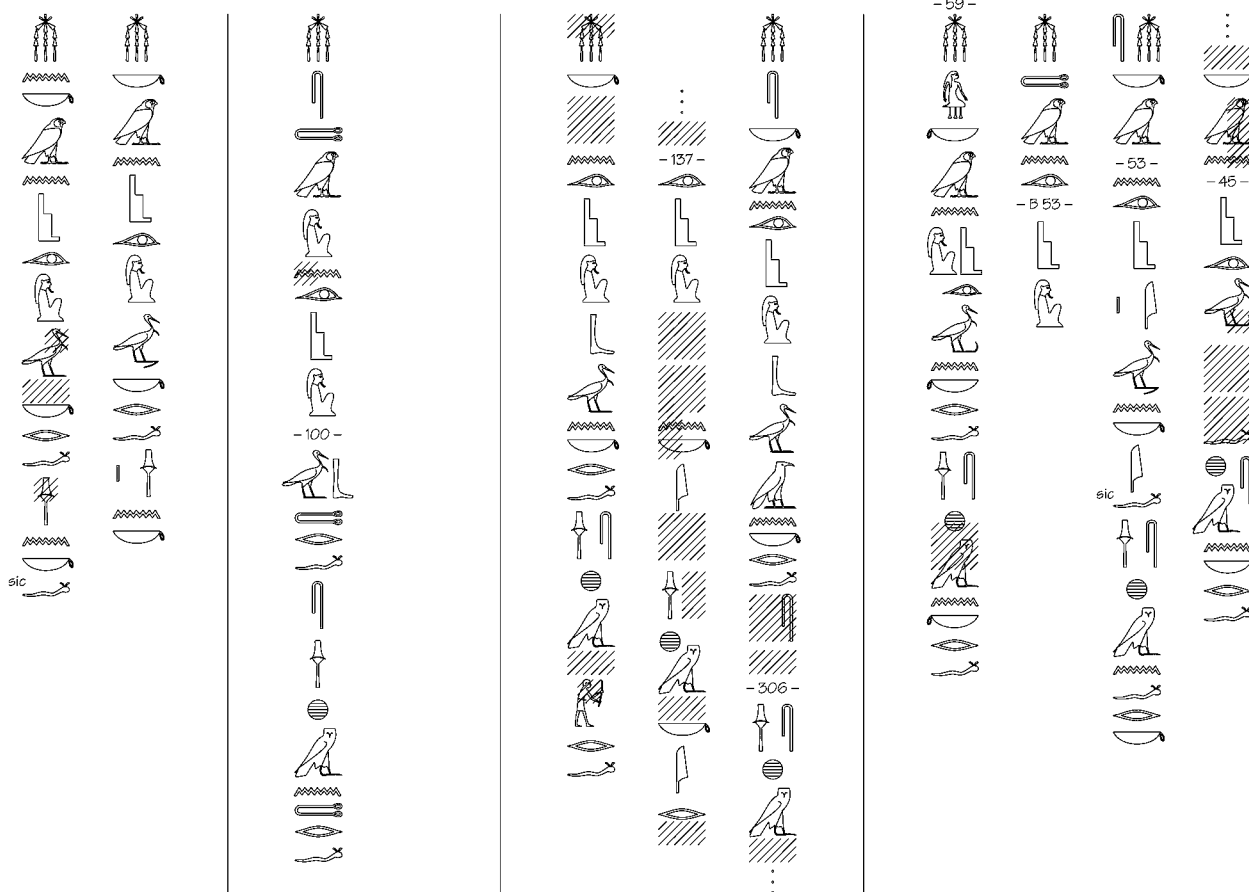

144b

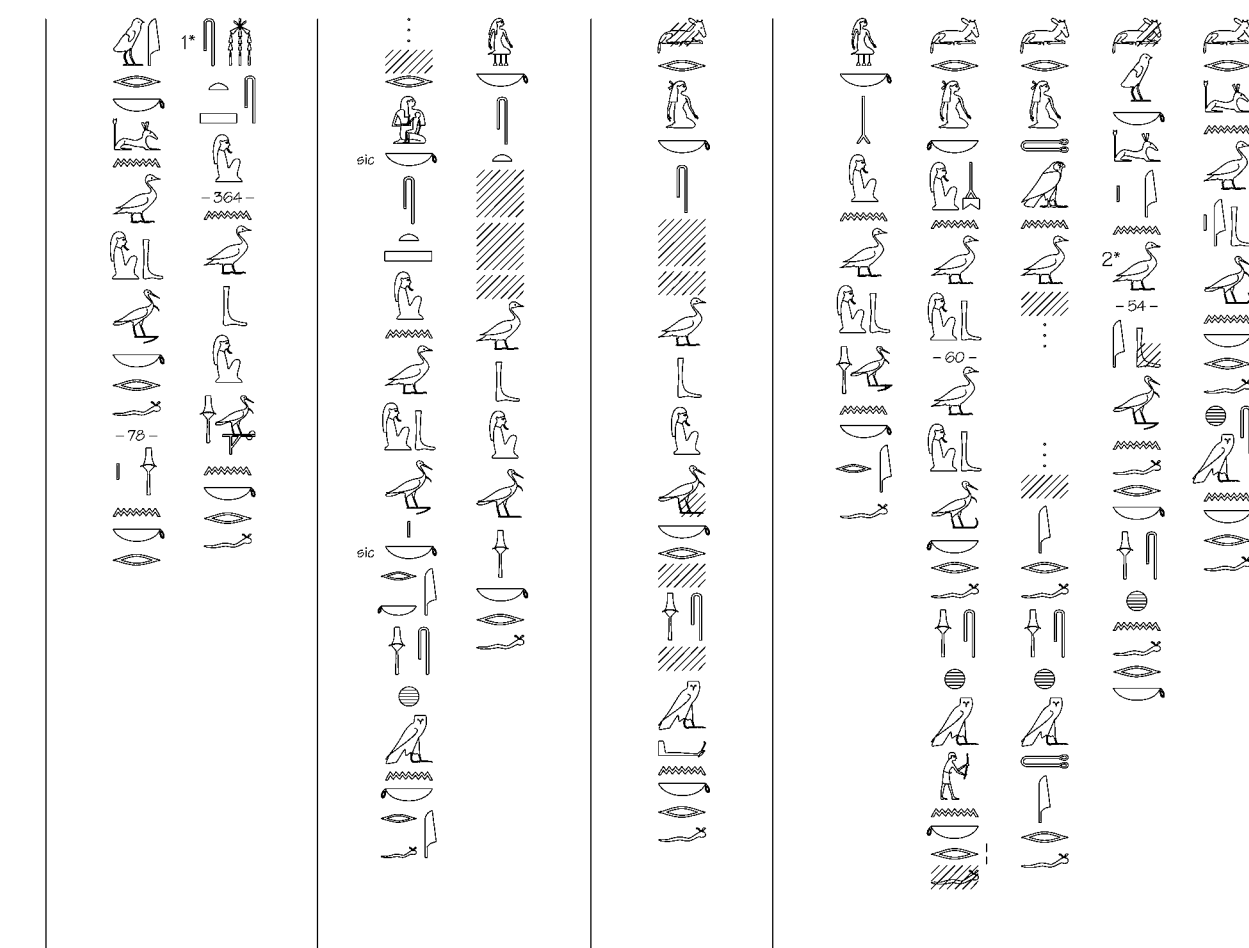

M5C M25C R1X T8C T9C T1L T1NY TT240 TT319

144a

--	--	--	--	--	--	--	--	--

144b

--	--	--	--	--	--	--	--	--

1\*

2\* Hieroglyphic sign.

Ab1Le <sup>a</sup>	Ab1Le <sup>b</sup>	Ab2Le	B4Bo	B6Bo	B4C	B6C	B10C <sup>a</sup>	B10C <sup>b</sup>	B10C <sup>c</sup>	B19C	BH3C	L-A1	M1C	M2C
--------------------	--------------------	-------	------	------	-----	-----	-------------------	-------------------	-------------------	------	------	------	-----	-----

145a

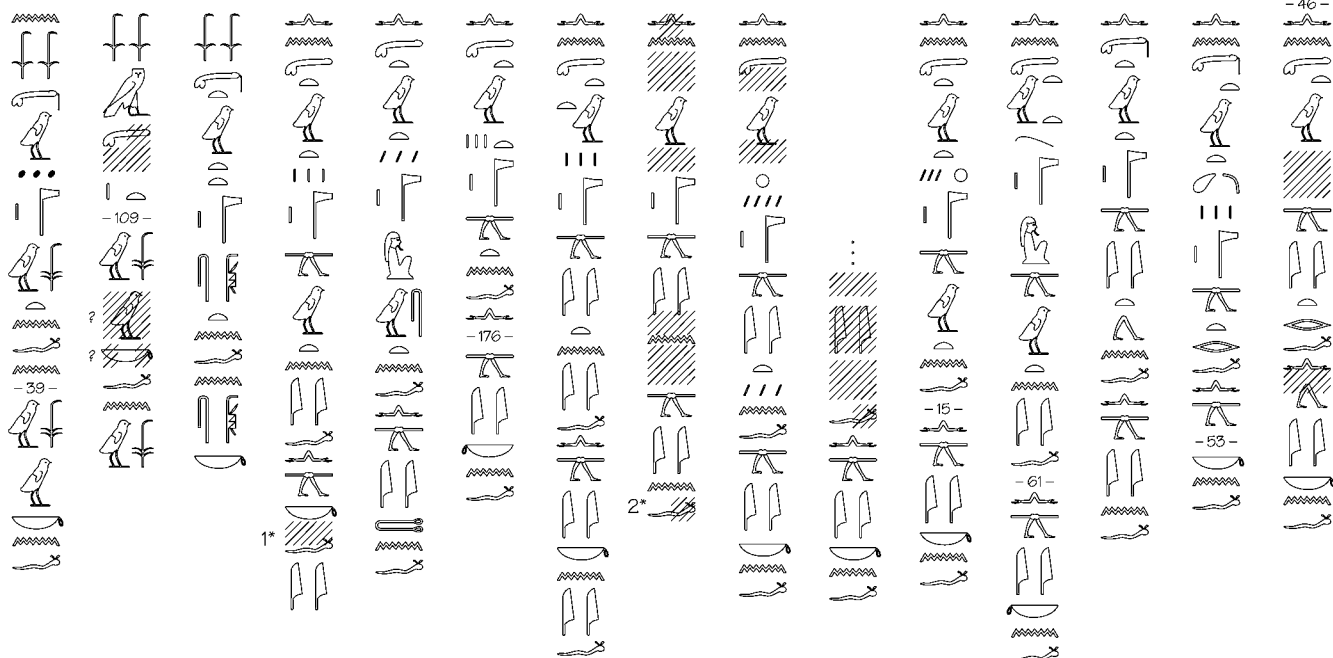

145b

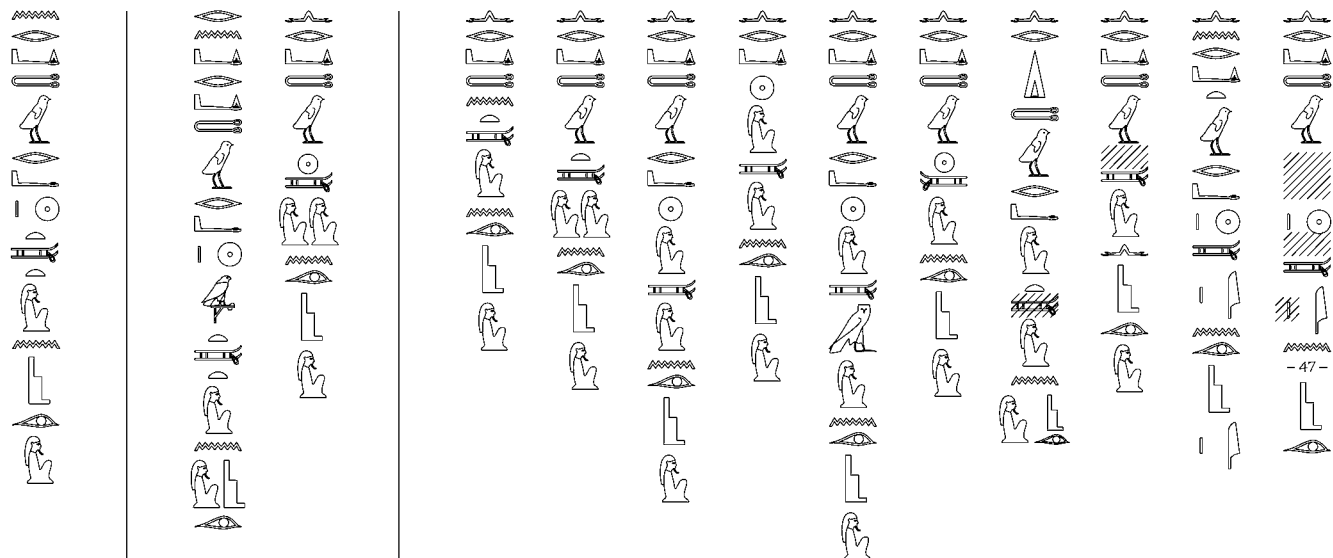



	M5C	M25C	R1X	T8C	T9C	T1L	T1NY	TT240	TT319
145a									
145b									

	M5C
143b	

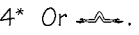
1\* Ligatured  ?  
 2\* Chiselmarks.  
 3\* Text above intervenes before Pyr. 145b.  
 4\* Or .

	Ab1Le <sup>a</sup>	Ab1Le <sup>b</sup>	Ab2Le	B4Bo	B6Bo	B4C	B6C	B10C <sup>a</sup>	B10C <sup>b</sup>	B10C <sup>c</sup>	B19C	BH3C	L-A1	M1C	M2C
--	--------------------	--------------------	-------	------	------	-----	-----	-------------------	-------------------	-------------------	------	------	------	-----	-----

(145b)

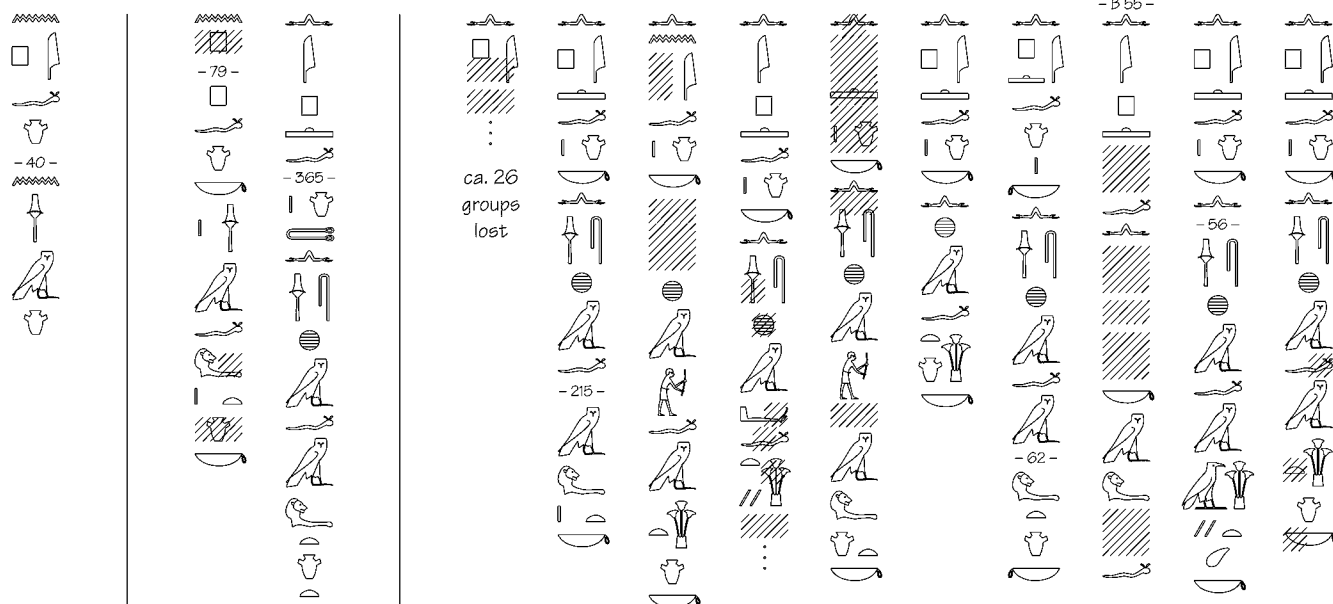

145c

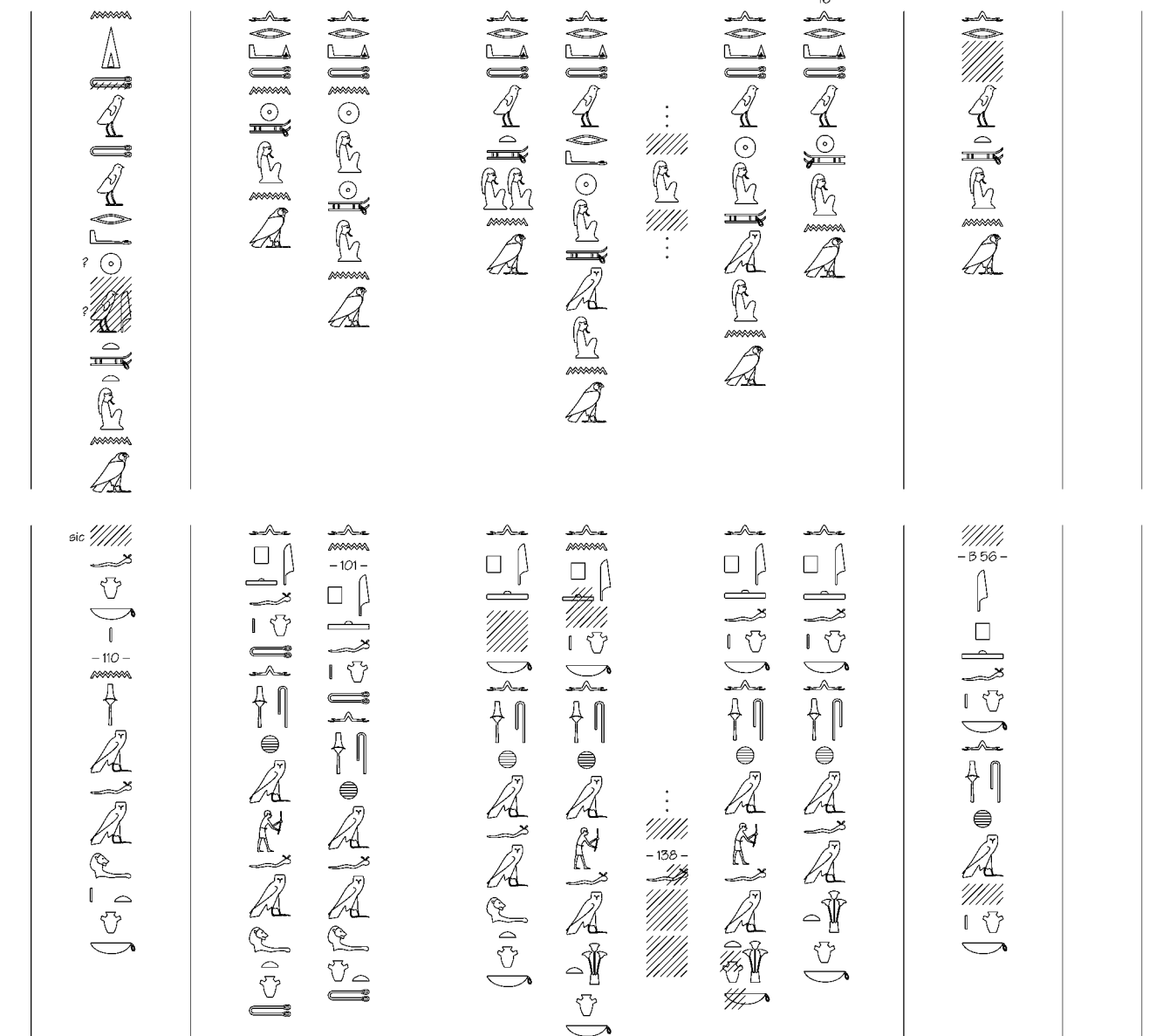

	M5C	M25C	R1X	T8C	T9C	T1L	T1NY	TT240	TT319
(145b)		<p>-25-</p>						<p>-44-</p>	<p>-57-</p>
145c					<p>-202-</p>				
		<p>-65-</p>						<p>-81-</p> <p>-45-</p>	<p>-203-</p>

Ab1Le <sup>a</sup>	Ab1Le <sup>b</sup>	Ab2Le	B4Bo	B6Bo	B4C	B6C	B10C <sup>a</sup>	B10C <sup>b</sup>	B10C <sup>c</sup>	B19C	BH3C	L-A1	M1C	M2C
--------------------	--------------------	-------	------	------	-----	-----	-------------------	-------------------	-------------------	------	------	------	-----	-----

146a

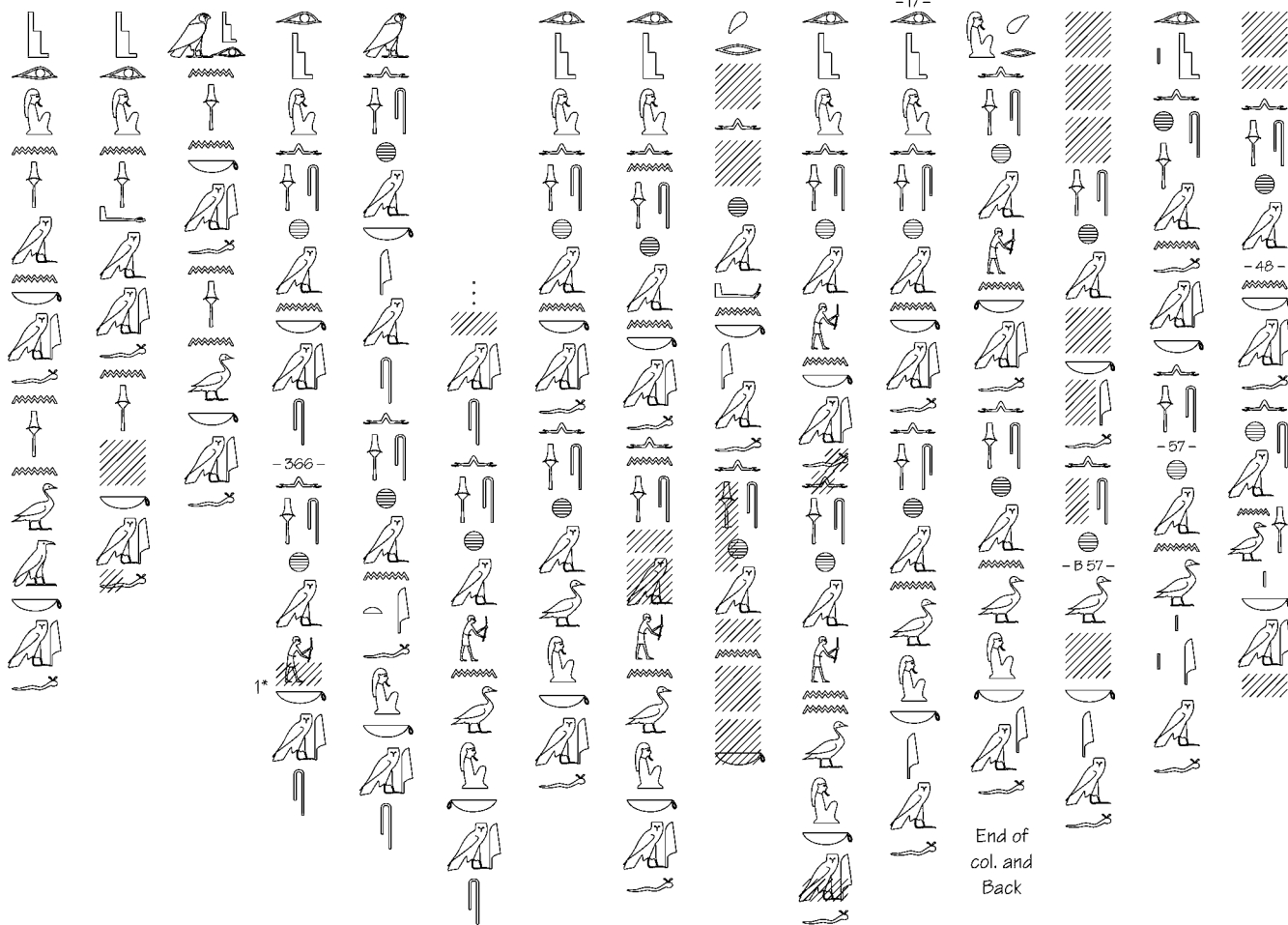

End of col. and Back

146b

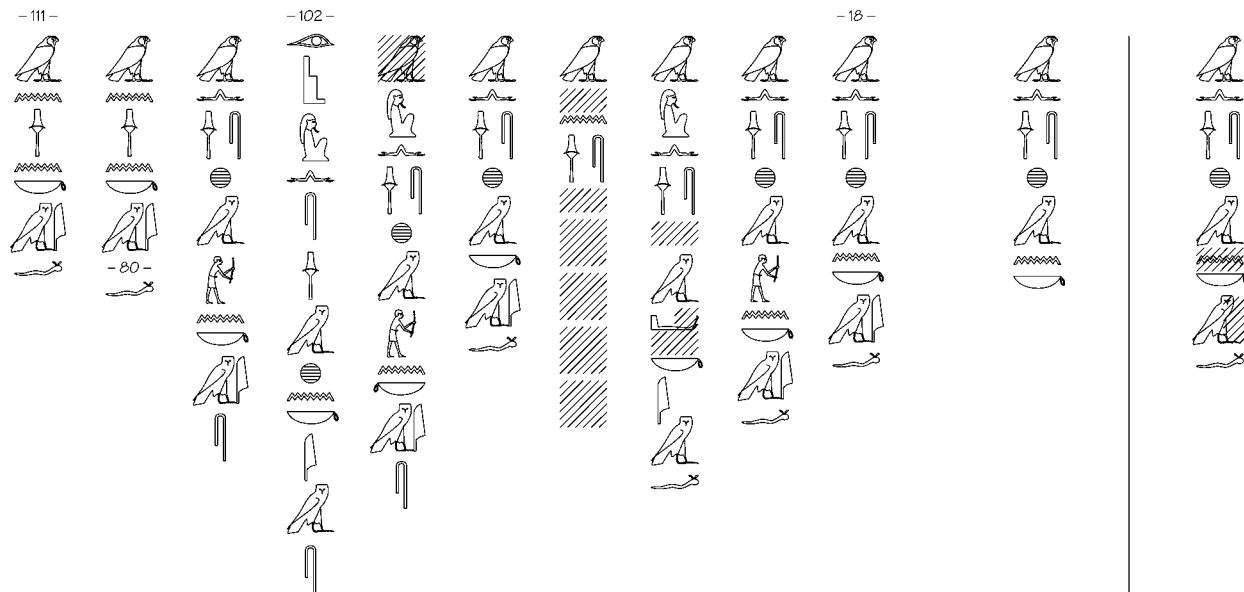

	M5C	M25C	R1X	T8C	T9C	T1L	T1NY	TT240	TT319
146a		<p>-26-</p> <p>...</p> <p>2*</p>				<p>-152-</p>			<p>-58-</p>
146b							<p>-83-</p>		<p>-59-</p>

1\* Not enough space for .  
 2\* Pyr. 147b follows after lacuna.  
 3\* Corrected over .

(146b)

Ab1Le<sup>a</sup> Ab1Le<sup>b</sup> Ab2Le B4Bo B6Bo B4C B6C B10C<sup>a</sup> B10C<sup>b</sup> B10C<sup>c</sup> B19C L-A1 M1C M2C M5C

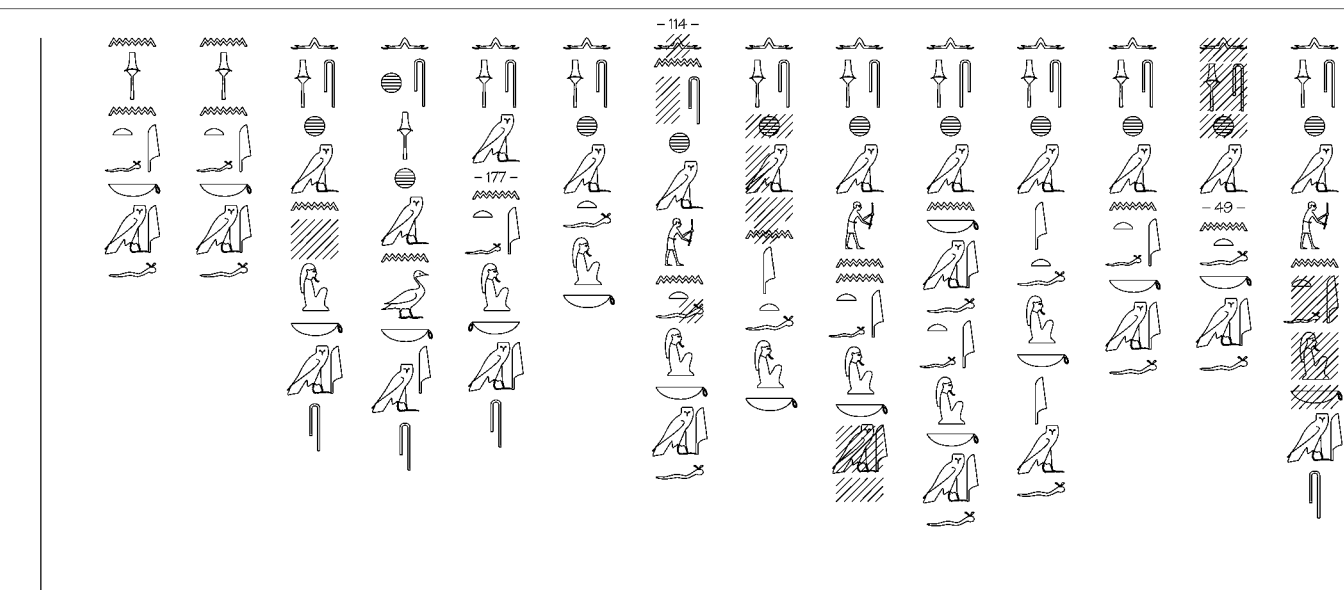

147a

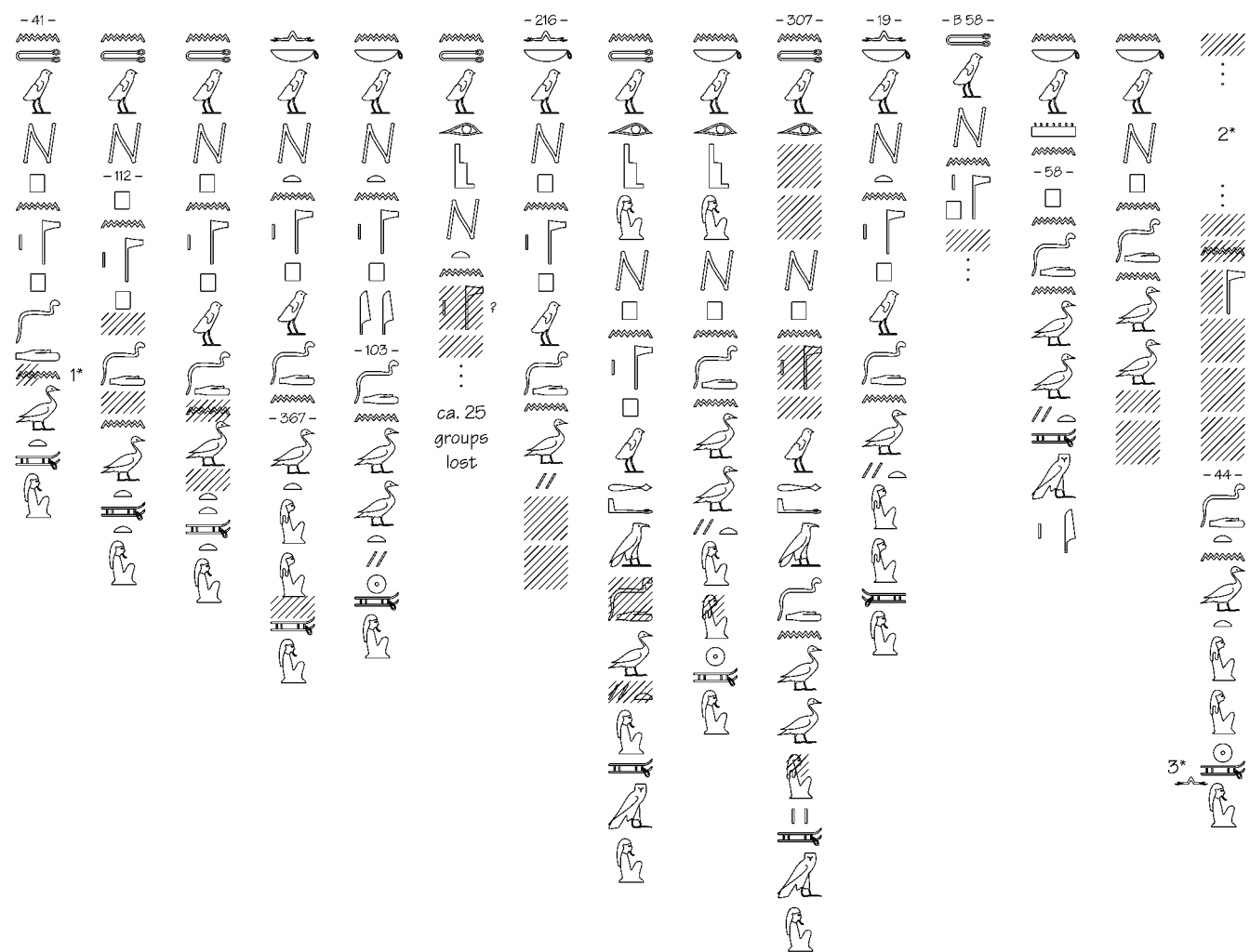

	R1X	T8C	T9C <sup>a</sup>	T9C	T1L	T1NY	TT240	TT319
(146b)								
147a								

1\* Or

2\* 8½ groups lost, of which 3-5 are for N.

3\* added secondarily.

4\* Apparently not N (*jmny*, usurped from *jn-t.f*).

5\* Inserted in PT 219, between Pyr. 186b and Pyr. 167a bis.

6\* Or

7\* Perhaps nothing.

147b

	Ab1Le <sup>a</sup>	Ab1Le <sup>b</sup>	Ab2Le	B4Bo	B6Bo	B4C	B6C	B10C <sup>a</sup>	B10C <sup>b</sup>	B10C <sup>c</sup>	B19C	L-A1	M1C	M2C	M5C

-42-  
-81-  
-50-  
-58-

-113-  
ca. 6 groups lost

-20-  
-58-

-B 59-  
2\*

1  
-50-  
-58-

-45-  
2\*

148a

-43-

ca. 6 groups lost

-104-

3\*

61c

1\*

-139-

-45-

4\*

5\*

-51-



	M25C	R1X	T8C	T9C <sup>a</sup>	T9C	T1L	T1NY	TT240	TT319
147b	-27-	-32-	-139-	-69-			End of col. and Back	-48-	
148a				6*					

1\* Chiselmarks.  
 2\* End of side. CT 520 intervenes before remainder of PT 215 on next side.  
 3\* Or ? (AHG)  
 4\* Pyr. 148c end follows after lacuna.  
 5\* Form like hieroglyphic .  
 6\* Pyr. 167a bis follows: see p. 99 n. 5.

	Ab1Le <sup>a</sup>	Ab1Le <sup>b</sup>	Ab2Le	B4Bo	B6Bo	B4C	B6C	B10C <sup>a</sup>	B10C <sup>b</sup>	B10C <sup>c</sup>	B19C	M1C	M2C	M5C	M25C
148b															
148c															

1\* End of register. PT 219 follows in next register.  
 2\* Chiselmarks—signs uncertain.  
 3\* Additional text on p. 103 intervenes before Pyr. 148d.

	R1X	T8C	T9C	T1L	TT240	TT319
148b						
148c						

	M1C
148d	
149d	
163c	
163d	

	Ab1Le <sup>a</sup>	Ab2Le	B4Bo	B6Bo	B4C	B6C	B10C <sup>a</sup>	B10C <sup>b</sup>	B10C <sup>c</sup>	B19C	L-A1	M1C	M2C	M5C	M25C
(148c)															
148d															

...

...  
-B 60-

1\*  
...  
-46-  
...

...

-369-

-308-

ca. 12 groups lost

	R1X	T8C	T9C	T1L	TT240	TT319
(148c)						
148d						

1\* See also p. 107.  
 2\* See also p. 103.

(148d)

Ab1Le <sup>a</sup>	Ab2Le	B4Bo	B6Bo	B4C	B6C	B10C <sup>a</sup>	B10C <sup>b</sup>	B10C <sup>c</sup>	B19C	L-A1	M1C	M2C	M5C	M25C
	-83-								-48-			-55-		-29-

149a

				-179-	-218-									
				ca. 24 groups lost										

1\* Additional text on p. 107 intervenes before Pyr. 149a.  
 2\* Text at right follows, then Pyr. 149a.

(148d)

	R1X	T8C	T9C	T1L	TT240	TT319
149a						

148c

	M5C	R1X

161a

161b

161c

	B6B0

(149a)

Ab1Le <sup>a</sup>	Ab2Le	B4Bo	B6Bo	B4C	B6C	B10C <sup>a</sup>	B10C <sup>b</sup>	B10C <sup>c</sup>	B19C	L-A1	M1C	M2C	M5C	M25C

149b

--	--	--	--	--	--	--	--	--	--	--	--	--	--	--



	R1X	T8C	T9C	T1L	TT240	TT319
(149a)						
149b						

1\* Group with preceding (𓄏), perhaps added secondarily.  
 2\* Sic—probably pr.t begun in error.  
 3\* Chiselmarks—signs uncertain.

Ab1Le<sup>a</sup> Ab2Le B4Bo B6Bo B4C B6C B10C<sup>a</sup> B10C<sup>b</sup> B10C<sup>c</sup> B19C L-A1 M1C M2C M5C M25C

(149b)

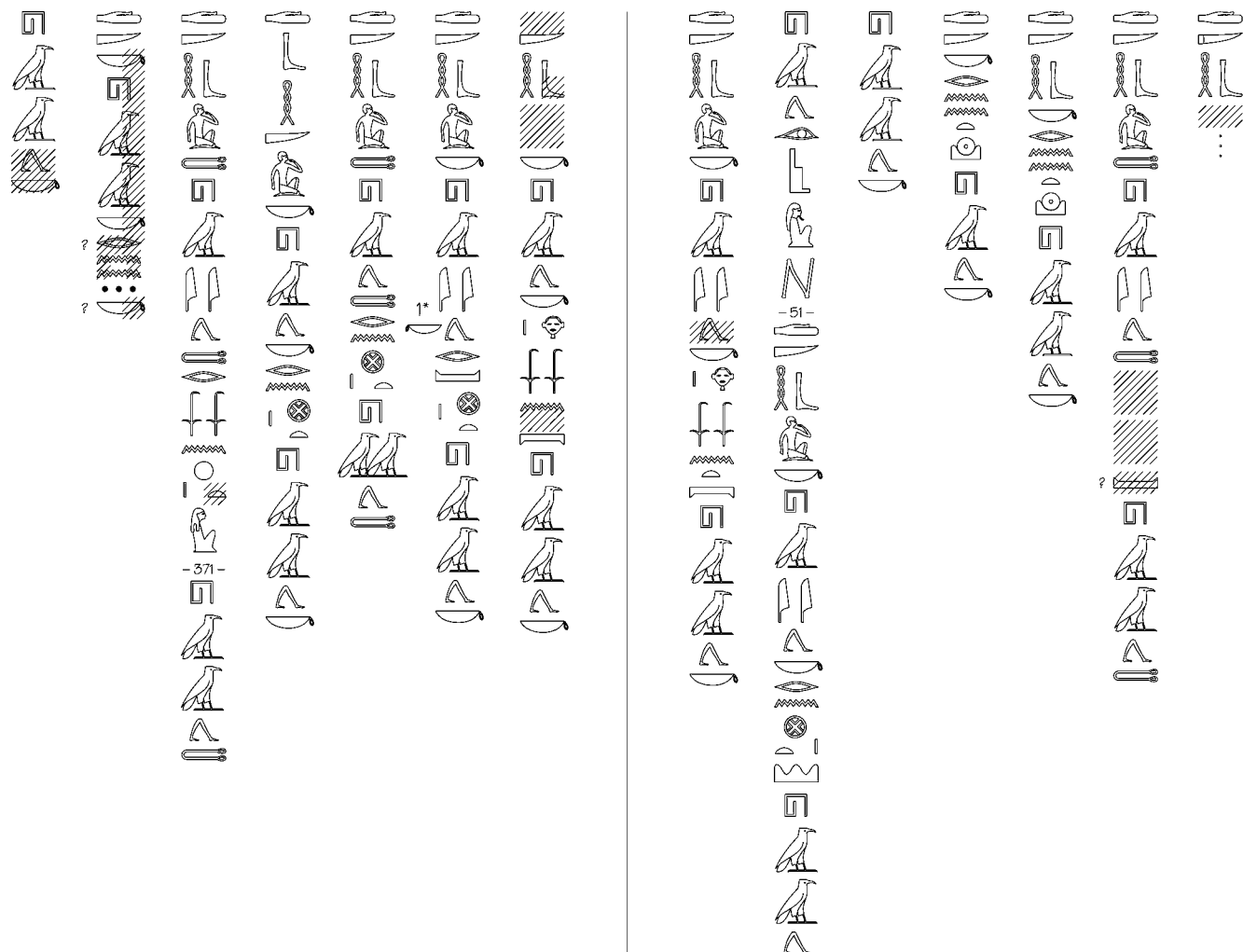

149c

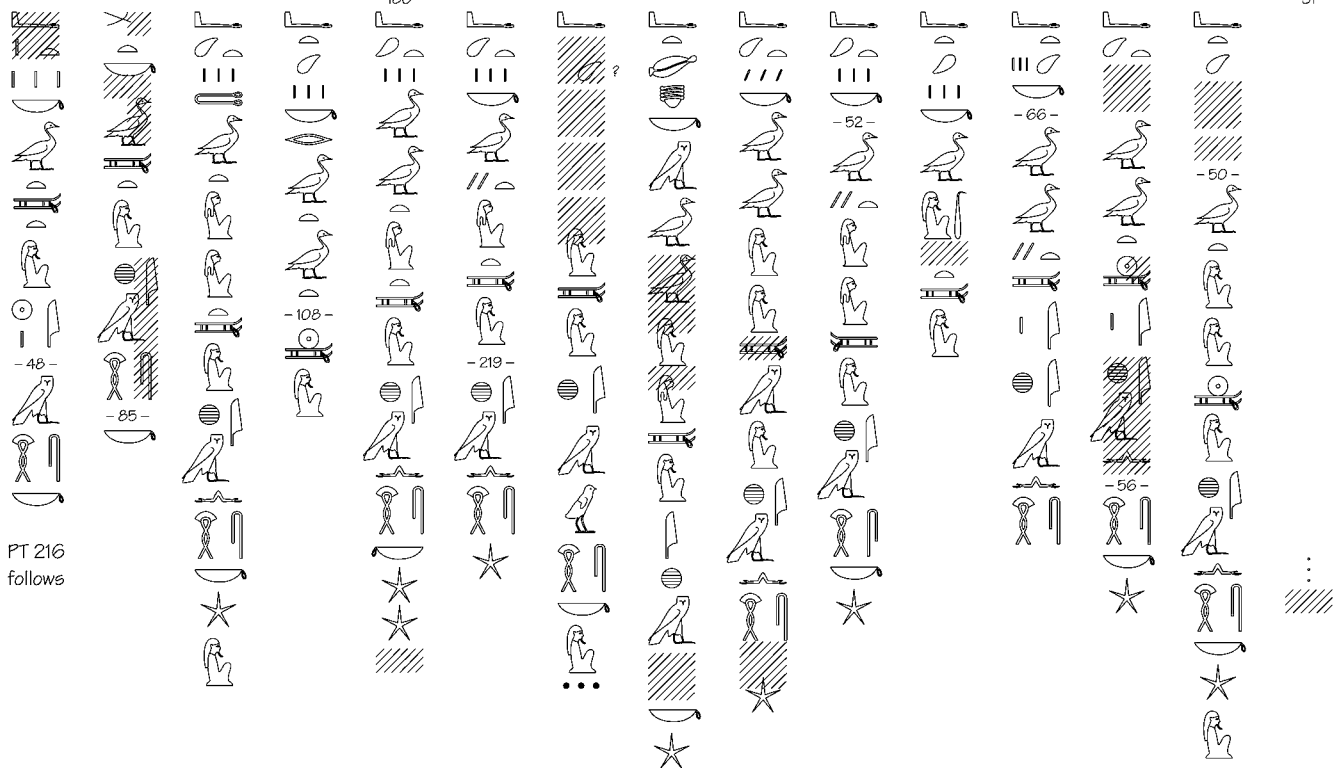

PT 216 follows

- 31 -

	R1X	T8C	T9C	T1L	TT240	TT319
(149b)						
149c						

1\* (sic) added secondarily.



	T8C	T9C	T1L	TT240	TT319
149d	-38- 	-217- 		-55- 	
	PT 216 follows	PT 216 follows	PT 216 follows	PT 216 follows	PT 216 follows

PT 216

	R1X	T8C	T9C	T1L	TT240	TT319
150a	-72- 	-38- 	-217- 	-155- 	-55- 	-66- 
			-218- 			
		-39- 				

1\* See also p. 103.



	R1X	T8C	T9C	T1L	TT240	TT319
150b						
150c						

1\* Chiselmarks—signs uncertain.  
 2\* Or .  
 3\* Or .  
 4\* ½ group blank.

151a

Ab1Le Ab2Le B4Bo B6Bo B4C B6C B10C<sup>a</sup> B10C<sup>b</sup> B10C<sup>c</sup> L-A1 M1C M2C M5C M25C R1X



151b

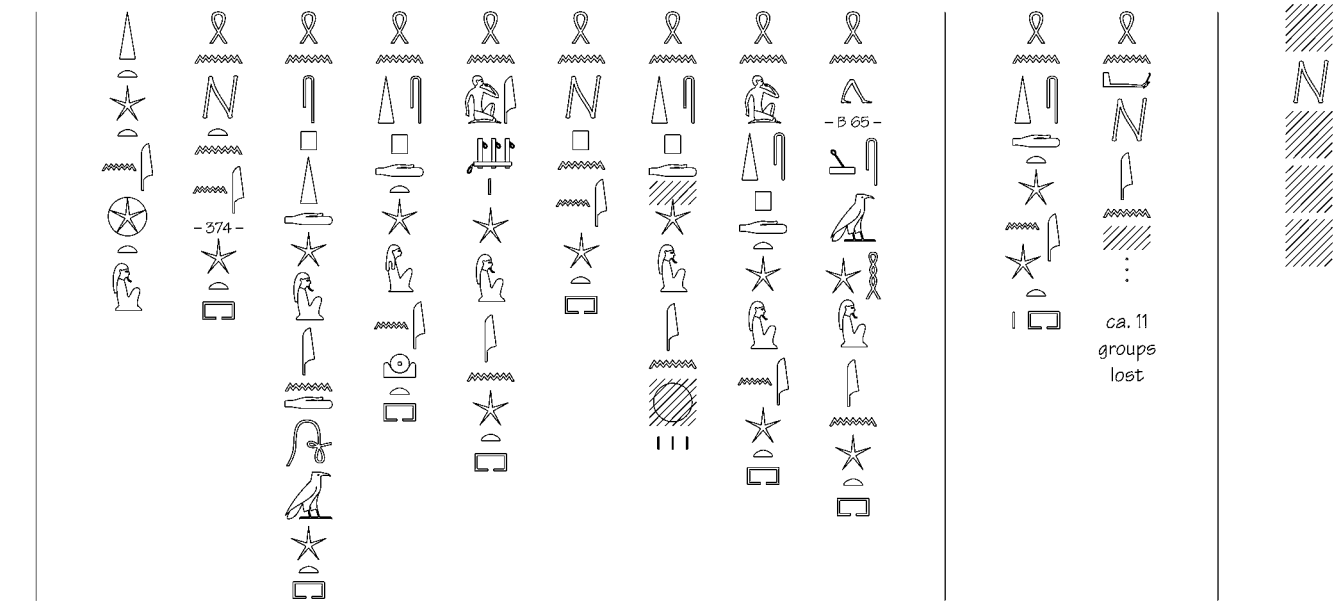



	T8C	T9C	T1L	TT240	TT319
151a		<p>-221-</p> <p>-156-</p> <p>-222-</p>			
151b		<hr/>		<p>-58-</p>	

1\* Chiselmarks—signs uncertain.



	T8C	T9C	T1L	TT240	TT319
(151b)					
151c					
151d					

M5C

1\* Text above intervenes before Pyr. 151d.

(151d)

Ab1Le Ab2Le B4Bo B6Bo B4C B6C B10C<sup>a</sup> B10C<sup>b</sup> B10C<sup>c</sup> L-A1 M1C M2C M5C M25C R1X

-34-

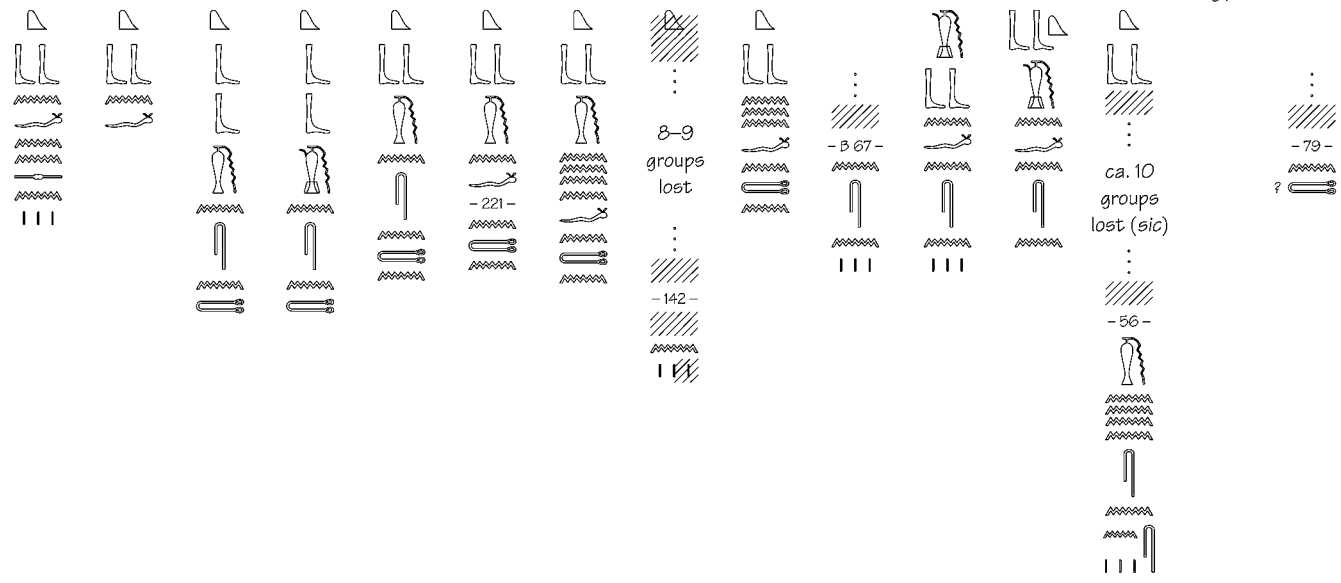

151e



PT 217 follows

PT 217 follows

PT 217 follows

PT 217 follows

PT 217 follows

PT 217 follows

3\*

3\*

PT 217 follows

PT 217 follows

PT 217 follows

3\*

PT 217 follows

3\*





	T8C	T9C	T1L	TT240
152a	-(44)- 	-(225)- 	-(157)- 	-(60)- 
152b				

B4B0	B6C
-(375)- 	-(221)- 

B4B0	B6C

MIC
-75- 

- 1\* Text on p. 123 precedes (= Pyr. 152a beginning + Pyr. 155d).
- 2\* Enough space for .
- 3\* Along left side of Bottom. PT 218 (Pyr. 166d) precedes.
- 4\* inserted secondarily; also corrected over erasure.
- 5\* AHG: "prob nothing"; LSB: "Don't agree unless tr. under is accidental. It seems too far to the left to be top of .
- 6\* End of line. Pyr. 153a follows in new line.
- 7\* Group corrected over erased .
- 8\* Text on p. 123 precedes follows before Pyr. 152c.
- 9\* End of column and Back.





	R1X	T8C	T9C	T1L
152c				
152d				

1\* Pyr. 155-56 follow after lacuna, then Pyr. 153-54.

2\* Text below follows, then only traces in cols. 85-86, then PT 219 in col. 87.

Ab1Le	Ab2Le	B4Bo	B6Bo	B4C	B6C	B10C <sup>a</sup>	B10C <sup>b</sup>	B10C <sup>c</sup>	L-A1	L2Li	M1C	M2C	M5C	M25C
-------	-------	------	------	-----	-----	-------------------	-------------------	-------------------	------	------	-----	-----	-----	------

153a

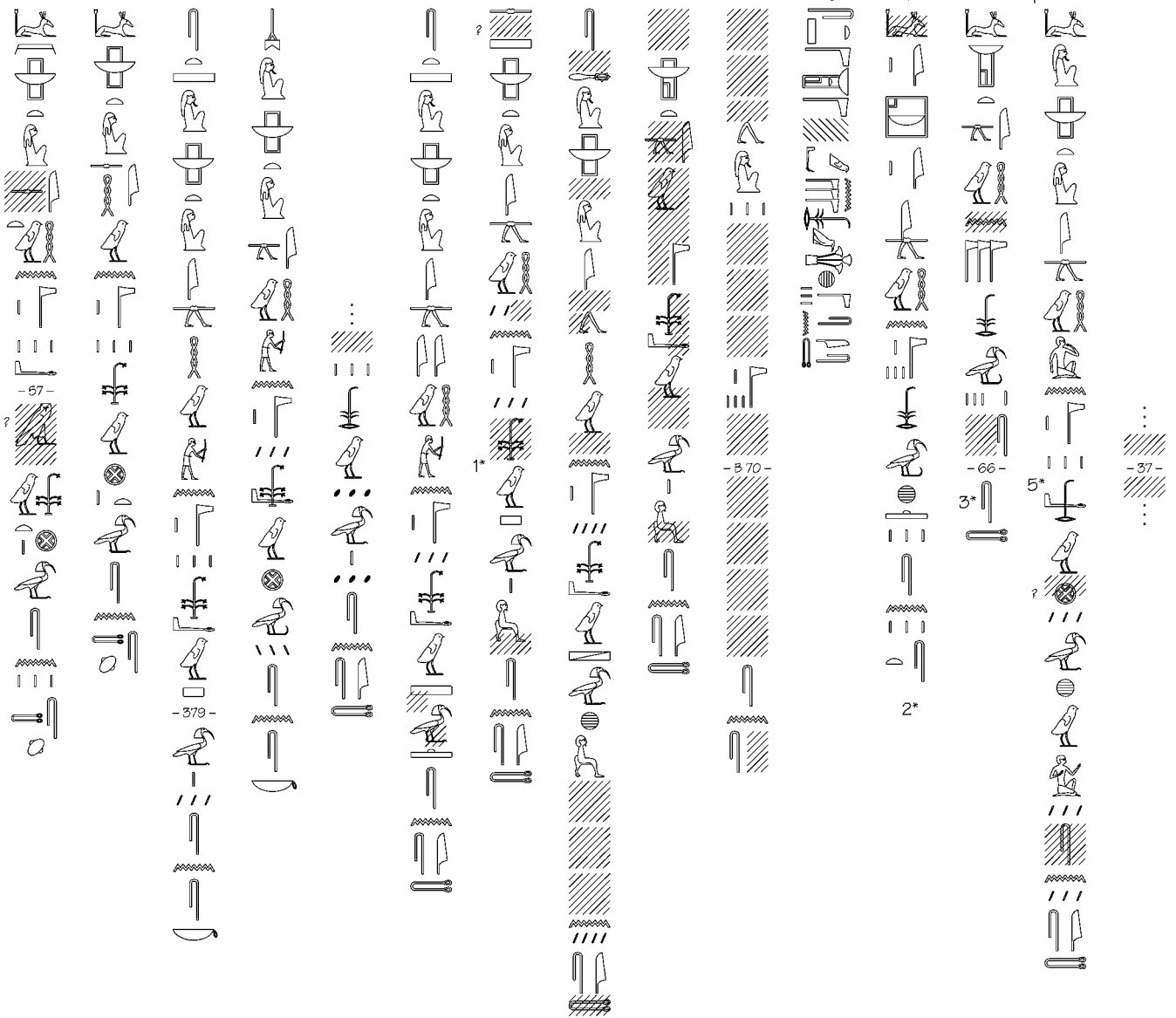

153b

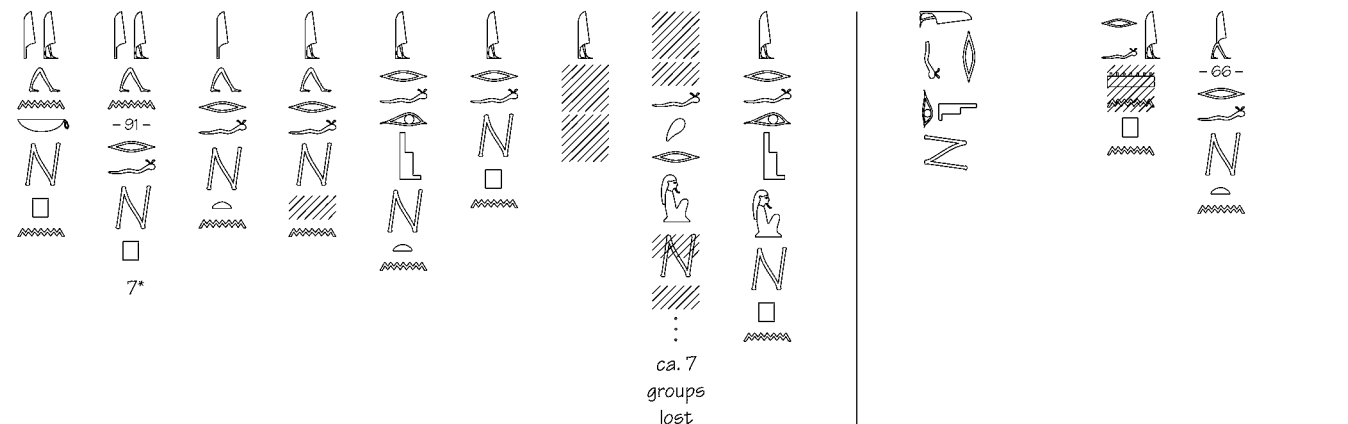

ca. 7 groups lost



Ab1Le Ab2Le B4Bo B6Bo B4C B6C B10C<sup>a</sup> B10C<sup>b</sup> B10C<sup>c</sup> L-A1 L2Li M2C M5C M25C T8C

(153b)

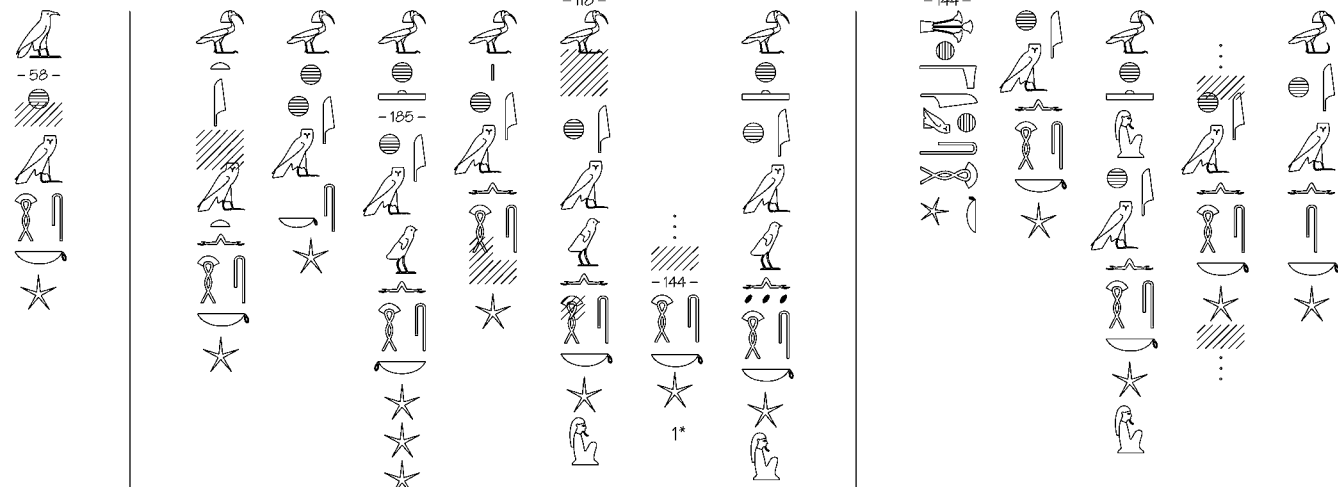

153c

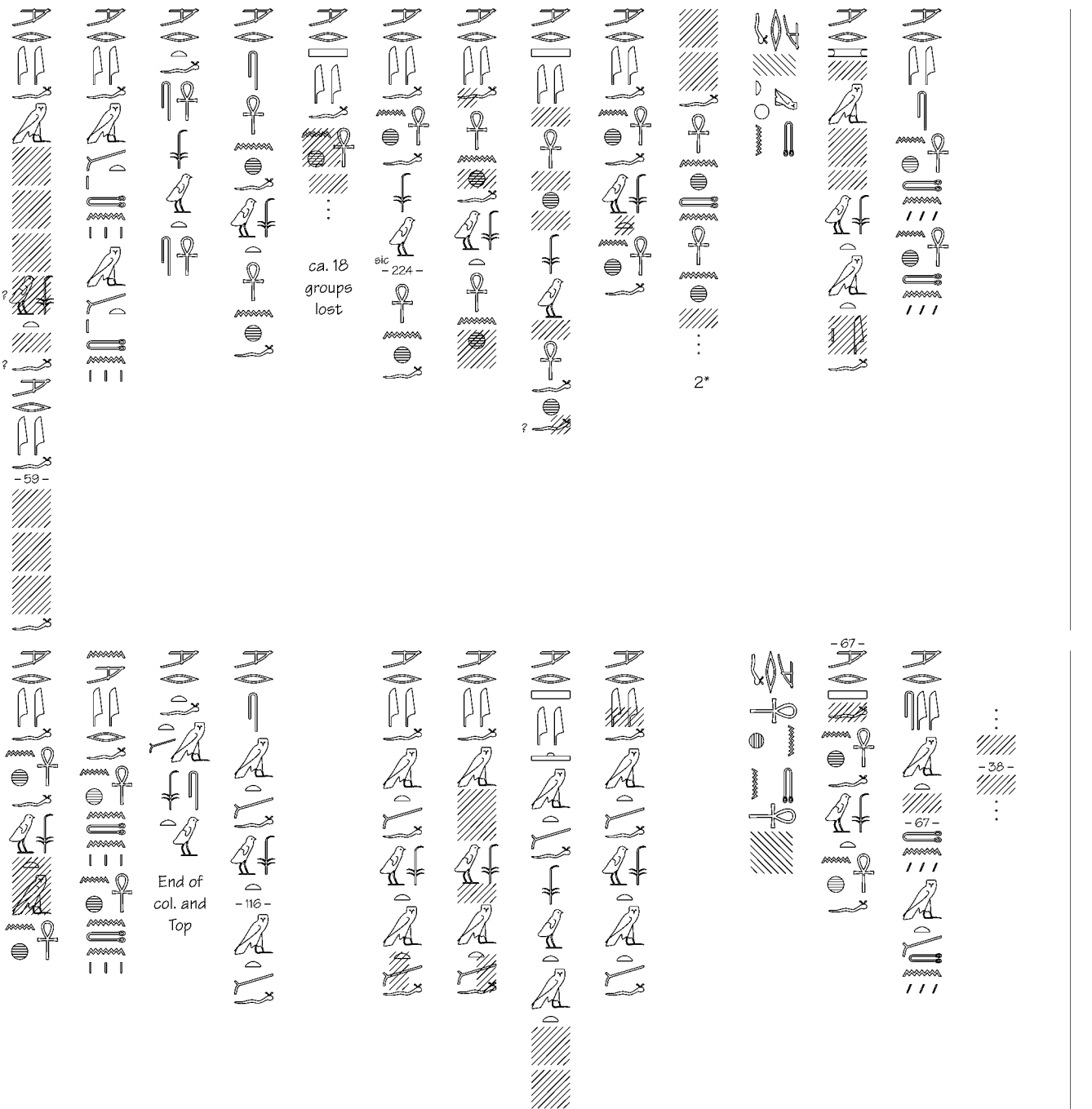

	T9C	T1L
(153b)		
153c		

	B10C <sup>b</sup>
(155b)	
155c	

1\* Text on p. 129 (= Pyr. 161b end-c) intervenes before Pyr. 153c.  
 2\* Pyr. 154b follows after lacuna.

154a

Ab1Le	Ab2Le	B6Bo	B4C	B6C	B10C <sup>a</sup>	B10C <sup>b</sup>	B10C <sup>c</sup>	L2Li	M2C	M5C	M25C	T8C	T9C	T1L

1\* Or

2\* Remainder of col. and cols. 39-44 illegible.  
Pyr. 157b follows after lacuna.

	Ab1Le	Ab2Le	B6Bo	B4C	B6C	B10C <sup>a</sup>	B10C <sup>b</sup>	B10C <sup>c</sup>	L-A1	L2Li	M2C	M5C	T8C	T9C	T1L
154b															
				ca. 18 groups lost											
154c															

1\* Chiselmarks:





(155a)

Ab1Le Ab2Le B4C B6C B10C<sup>b</sup> B10C<sup>c</sup> M2C M5C T9C T1L

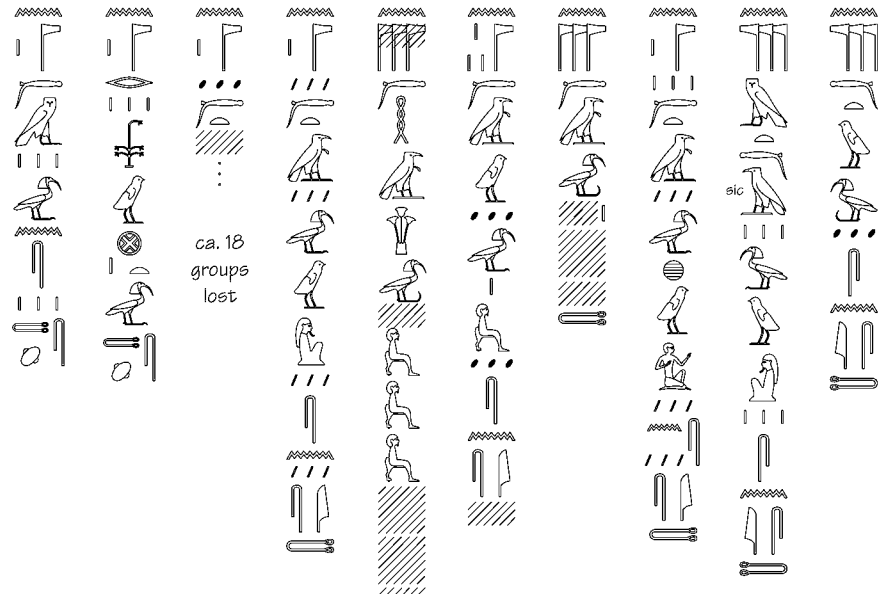

155b



1\* Not tn.  
2\* See p. 129 n. 1.

	Ab1Le	Ab2Le	B4C	B6C	B10C <sup>p</sup>	B10C <sup>c</sup>	B19C	M2C	M5C	T9C	T1L
155c											
155d											

...  
ca. 18  
groups  
lost

1\* See p. 129 n. 1.  
2\* Corrected over

156a

Ab1Le	Ab2Le	B4C	B6C	B10C <sup>b</sup>	B10C <sup>c</sup>	B19C	M2C	M5C	T9C	T1L
	<p>End of col. and Bottom</p>									

1\* Pyr. 157a follows.

	Ab1Le	B4C	B6C	B10C <sup>b</sup>	B10C <sup>c</sup>	B19C	M5C	T9C	T1L
156b								<p>- 245 -</p>	
		End of col. and Back							
156c			<p>- 227 -</p>					<p>- 246 -</p>	

1\* Hieroglyphic sign.  
 2\* Perhaps nothing lost.

	Ab1Le	B6Bo	B6C	B10C <sup>b</sup>	B10C <sup>c</sup>	B19C	M2C	M5C	T9C	T1L
156d										
157a										

-314-

-67-

1\*

2\*

-70-

-148-

ca. 9 groups lost

-249-

-228-

1\* Pyr. 153a follows.  
 2\* Pyr. 154d precedes.

157b

Ab1Le	B6Bo	B6C	B10C <sup>b</sup>	B10C <sup>c</sup>	B19C	M2C	M5C	M25C	T9C	T1L
	<p>-119-</p>							<p>-45-</p>		<p>-162-</p>
								<p>-250-</p>		
								<p>-75-</p>		
								<p>-71-</p>		
								<p>-251-</p>		
								<p>-76-</p>		
								<p>-72-</p>		

End of col. and side

1\* Trace of N before pn.  
 2\* See p. 143.

	Ab1Le	B6Bo	B6C	B10C <sup>b</sup>	B10C <sup>c</sup>	M2C	M5C	M25C	T9C	T1L
157c		-120- 						... -46- ...	-252- 	
157d								... -46- ...	-253- 	
								... -47- ...	-254- 	
		End of col. and Top								

1\* See p. 143.

158a











































































































































































	Ab1Le	B6C	B10C <sup>b</sup>	B10C <sup>c</sup>	M2C	M5C	M25C	T9C	T1L



158b

Ab1Le B6C B10C<sup>b</sup> B10C<sup>c</sup> M2C M5C M25C T9C T1L

158c

ca. 19 groups lost

1\* Traces suit mn pn (AdB).

	Ab1Le	B6C	B10C <sup>b</sup>	B10C <sup>c</sup>	M2C	M5C	M25C	T9C	T1L
158d		<p>ca. 9½ groups lost</p>					<p>-49-</p>	<p>-257-</p>	
159a		<p>ca. 13½ groups lost</p>						<p>-164-</p>	

1\* Probably nothing lost.  
 2\* Along right side of Bottom, beginning lost.

	Ab1Le	B6C	B10C <sup>b</sup>	B10C <sup>c</sup>	L2Li	M2C	M5C	M25C	T9C	T1L
(159a)					-155- 2* 					
159b										
159c										

	B10C <sup>b</sup>
157b	
157c	
	PT 218 follows

1\* Ca. 8½ groups lost. Text above follows.  
 2\* Along right side of Bottom, beginning lost.

	Ab1Le	B6C	B10C <sup>c</sup>	L2Li	M2C	M5C	M25C	T9C	T1L
(159c)									
160a									

	M5C
c	
d	

PT 218 follows

1\* See also p. 121.  
 2\* Text above follows  
 (= Pyn. 152/154/156/158c-d).

	Ab1Le	B6C	B10C <sup>c</sup>	L2Li	M2C	M25C	T9C	T1L
160b ↑*								
	-75-	-232-				-52-	-260-	-165-
160c ↑*								
	-76-			2*				
	PT 218 follows	PT 218 follows	PT 218 follows	PT 218 follows	PT 218 follows	3*	PT 218 follows	PT 218 follows

1\* See also p. 121.

2\* AHG assigns this group to the beginning of PT 218, but traces better suit this reading.

3\* End of col. blank. PT 222 follows in next col.

	Ab1Le	B6Bo	B6C	B10C <sup>a</sup>	B10C <sup>b</sup>	M2C	M5C	T9C	T1L	TT319
161a	<p>-(76)-</p> <p>End of col. and Top</p>	<p>-(232)-</p>	<p>-(150)-</p>	<p>-(316)-</p>	<p>-(83)-</p> <p>-84-</p>	<p>-(80)-</p>	<p>-(261)-</p> <p>-262-</p>	<p>-(165)-</p>	<p>-(72)-</p> <p>-73-</p>	<p>-(72)-</p>
		see p. 105								
161b		see p. 105					<p>-263-</p>			

	B6B0	B6C	B10C <sup>a</sup>	B10C <sup>b</sup>	M2C	M5C	T9C	T1L	TT319
(161b)		-233- 			-85- 				-74- 
		see p. 105							
161c				-317- 		-82- 	-264- 	-166- 	
		see p. 105							
			-151- 						-75- 
			ca. 9½ groups lost						

1\* Over an incomplete

	B6C	B10C <sup>a</sup>	B10C <sup>b</sup>	M2C	M5C	T9C	T1L	TT319
(162a)								
162b								
162c								

-265-

-83-

-87-

-266-

-76-



(162c)

B6C B10C<sup>a</sup> B10C<sup>b</sup> M2C M5C T9C T1L TT319

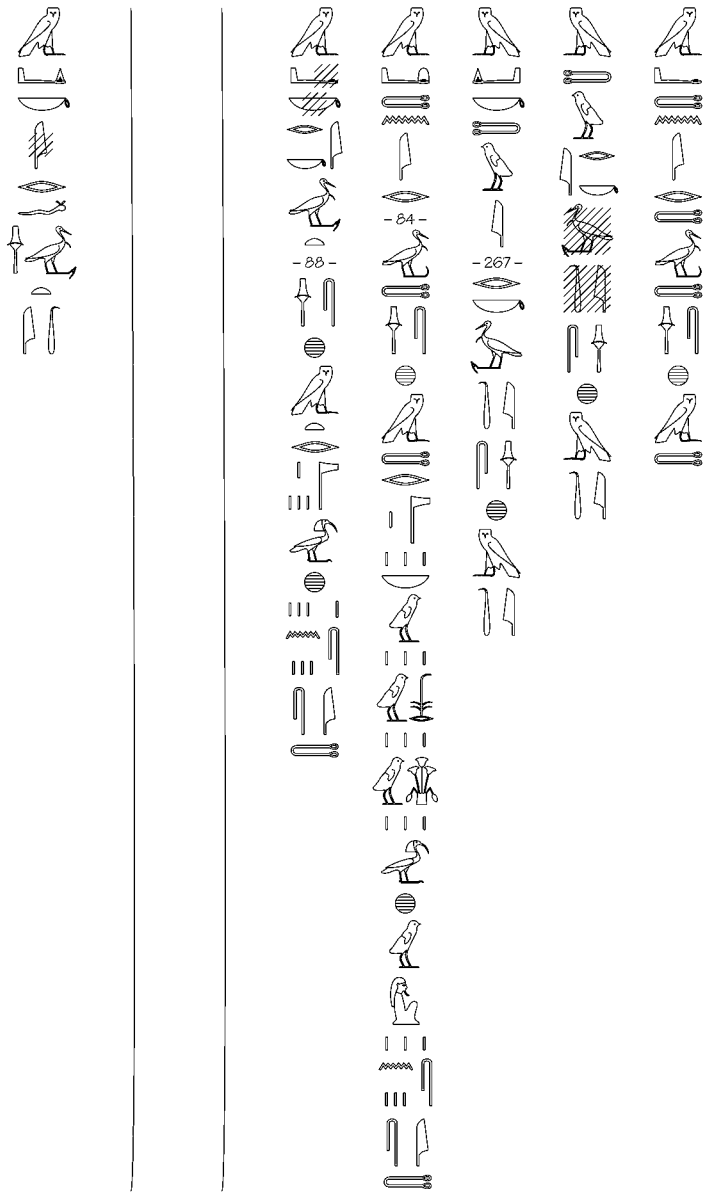

163a





	B6C	B10C <sup>a</sup>	B10C <sup>b</sup>	BH1C	M2C	M5C	T9C	T1L	TT319
163c 1*									
163d 1*									

1\* See also p. 103.  
2\* This group chiselmarks only; signs uncertain.

	B6C	B10C <sup>a</sup>	B10C <sup>b</sup>	BH1C	M2C	M5C	T9C	T1L	TT319
(163d) 1*									
		2*  ca. 16 groups lost							
164a									
				3* End of col. and Back					

1\* See also p. 103.  
 2\* Not enough space for ; perhaps nothing lost.  
 3\* AHG recorded ; AdB suggested .

	B6C	B10C <sup>a</sup>	B10C <sup>b</sup>	BH1C	M5C	T9C	T1L	TT319
(164a)								
		⋮						
164b						—		
		1*			-2-			
		2*						81-
164c				—				
						-273-		

1\* Or .  
 2\* Perhaps nothing lost.

	B6C	B10C <sup>a</sup>	B10C <sup>b</sup>	BH1C	M5C	T9C	T1L	TT319
(164c)			 ca. 7 groups lost					
164d				 End of col. and Lid		 -274-		 -82-
164e	 PT 219 follows	 -153- ca. 8½ groups lost			 -4- -275-	 -169- -276-		

	B6C	B10C <sup>a</sup>	B10C <sup>b</sup>	L2Li	M5C	T9C	T1L	TT319
165a	<p>see 164d</p>		<p>see 164d?</p>	<p>1*</p>				<p>-83-</p>
165b	<p>see 164e</p>		<p>see 164e?</p>					

1\* Along right side of Bottom.  
 PT 217 (Pyr. 160c) precedes.  
 Restore at beginning.

	B10C <sup>a</sup>	B10C <sup>b</sup>	L2Li	M5C	T9C	T1L	TT319
165c			-156- 				
165d							

	B10C <sup>a</sup>	B10C <sup>b</sup>	L2Li	M5C	T9C	T1L	TT319
166a			-147- 				
166b							

1\* PT 217 (Pyr. 154d) precedes.  
2\* End of line. CT 529 follows.



	B10C <sup>a</sup>	B10C <sup>b</sup>	M5C	T9C	T1L	TT319
166c						
166d						
	PT 219 follows	PT 219 follows	PT 219 follows	PT 219 follows	PT 219 follows	PT 219 follows

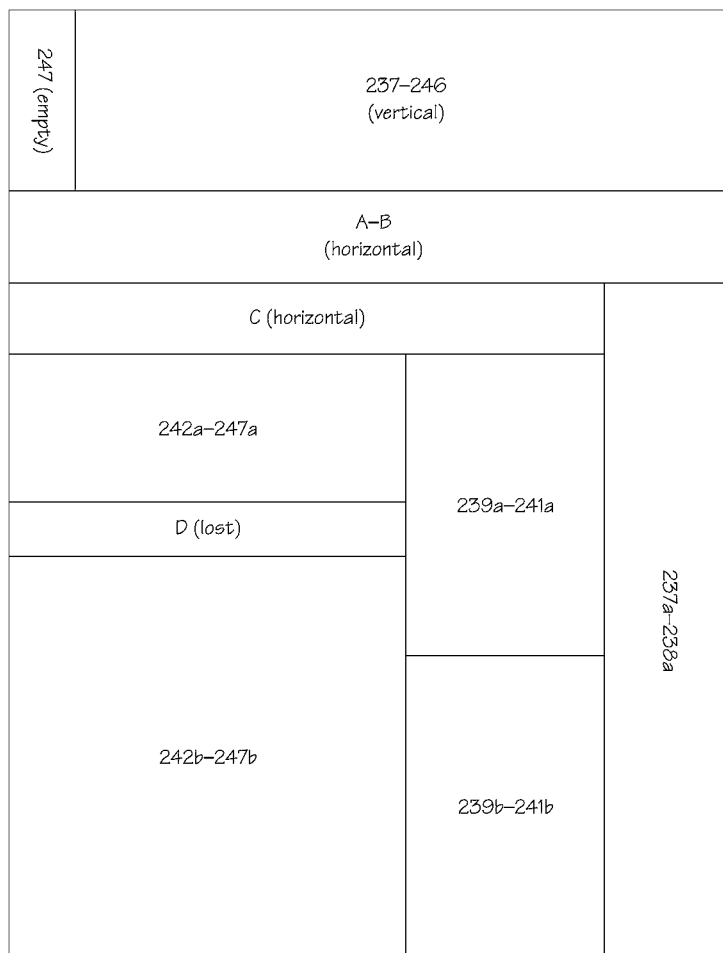

Plan of B6C 237-247 (PT 219)

Notes to p. 158:

- 1\* See the plan on p. 157.
- 2\* In this spell, *N pn* is regularly preceded by except where noted.
- 3\* See p. 183 n. 2.
- 4\* Group with following.
- 5\* No .
- 6\* Cols. 87b-98b, 99c-101c, and 102b-109b are the ends of cols. 87-101, without division lines.

	Ab1Le	Ab2Le	B6C	B10C <sup>a</sup>	B10C <sup>b</sup>	M5C	Sed1Cam	T9C <sup>a</sup>	T9C <sup>b</sup>	T1L	TT319
167a	-114- 	-17- 	-237- 	-156- 	-319- 	-10- 	-(45)- 	-(285)- 	3* -139- 	-171- 	-87a- 
167b											6* -87b- 
			2*	ca. 5 groups lost							4* 5* sic

For notes see p. 157.

	Ab1Le	Ab2Le	B6C	B10C <sup>a</sup>	B10C <sup>b</sup>	M5C	Sed1Cam	T9C <sup>a</sup>	T9C <sup>b</sup>	T1L	TT319
(167b)	 -115-	 -18-	 1*					 -287- -47-	 -141-		 -89b- -90b-
167c	 -19- ca. 1/3 col. lost	 -19-	 -5- ca. 16 groups lost	 156 ca. 16 groups lost		 -12-		 -288-	 -172- -142-		 -91b- -92b-
			 94b				 -289-	 -95b-	 -96b- -97b-	 94b	 -95b- -96b-
				 -143-				 -143-			

1\* Group with preceding.

	Ab1Le	Ab2Le	B6C	B10C <sup>a</sup>	B10C <sup>b</sup>	M5C	R1X	Sed1Cam	T9C <sup>a</sup>	T9C <sup>b</sup>	T1L	TT319
167d												
168a												

1\* Pyr. 185 (T9C<sup>b</sup>) follows.  
 2\* Text at right follows.  
 3\* Illegible traces in the two preceding cols.

	Ab1Le	Ab2Le	B6C	B10C <sup>a</sup>	B10C <sup>b</sup>	M5C	R1X	Sed1Cam	T9C	T1L	TT319
168b			<p>see 167b</p>								<p>see 167b</p>
			<p>see 167b</p>	<p>ca. 9 groups lost</p>		<p>End of col. and Head</p>	<p>End of col. and Back</p>		<p>End of col. and Front</p>		<p>see 167b</p>
168c			<p>see 167c</p>								<p>see 167c</p>

1\* Rest of col. lost. Mere traces in col. 49, which ends the Back.  
 2\* Perhaps nothing lost.  
 3\* PT 219 continues on the Back with Pyr. 181-193.

	Ab1Le	Ab2Le	B6C	B10C <sup>a</sup>	B10C <sup>b</sup>	T1L	TT319
(168c)							
			see 167c				see 167c
				- 321 -			
168d							
			see 167d				see 167d
169a							
			- 239 -				- 89a -
			see 167a				

	Ab1Le	Ab2Le	B6C	B10C <sup>a</sup>	B10C <sup>b</sup>	T1L	TT319
(169a)							
			see 167a				
				- 158 -			
169b							
			see 167b				see 167b
				ca. 14 groups lost			
			see 167b				see 167b
				- 120 -			
169c							
			see 167c				see 167c

1\* Or

	Ab1Le	Ab2Le	B6C	B10C <sup>a</sup>	B10C <sup>b</sup>	T1L	TT319
(169c)							
			see 167c				see 167c
169d							
			see 167d				see 167d
170a			-240-				-90a-
			see 167a				
	ca. 7 groups lost						
			see 167a				

	Ab1Le	Ab2Le	B6C	B10C <sup>a</sup>	B10C <sup>b</sup>	T1L	TT319
(170a)							
			see 167a				
170b							
			see 167b				see 167b
			see 167b				see 167b
170c							
			see 167c				see 167c
					-322-		
			see 167c				see 167c

	Ab1Le	Ab2Le	B6C	B10C <sup>a</sup>	B10C <sup>b</sup>	T1L	TT319
(170c)							
			see 167c				see 167c
170d			see 167d				see 167d
171a			-241-				-91a-
			see 167a				

	Ab1Le	Ab2Le	B6C	B10C <sup>a</sup>	B10C <sup>b</sup>	T1L	TT319
(171a)							
			see 167a				
171b			see 167b				see 167b
171c			see 167c				see 167c



	Ab1Le	Ab2Le	B6C	B10C <sup>a</sup>	B10C <sup>b</sup>	T1L	TT319
(171c)			see 167c				see 167c
171d			see 167d				see 167d
172a			-242- 				-92a- 

	B10C <sup>a</sup>	B10C <sup>b</sup>
a	-161- 	
b		
		see d

	B10C <sup>a</sup>	B10C <sup>b</sup>
c		
d		

1\* Text at right intervenes before Pyr. 172a.  
 2\* ◁ corrected to l, or canceled.

	Ab1Le	Ab2Le	B6C	B10C <sup>a</sup>	B10C <sup>b</sup>	T1L	TT319
(172a)			—				
172b			—				
			—				
			—				
172c			—				

	Ab1Le	Ab2Le	B6C	B10C <sup>a</sup>	B10C <sup>b</sup>	T1L	TT319
(172c)	—	—	—				—
172d			—				—
			—				—

1\* Col. 125 lost. End of Bottom.  
 2\* Pyr. 175 follows (Pyr. 173-74 omitted).

Notes to p. 167:  
 1\* Preceding lines lost.  
 2\* Added secondarily to right of Pyr. 173b

	Ab2Le	B6C	B10C <sup>a</sup>	B10C <sup>b</sup>	L2Li	T1L	TT319
173a		-243- sic			1*		-93a- 
		see 167a			ca. 6 groups lost		
173b		see 167b		... -324- 	... -157- 		see 167b
		see 167b					see 167b

For notes see p. 166.

	Ab2Le	B6C	B10C <sup>a</sup>	B10C <sup>b</sup>	L2Li	T1L	TT319
(173b)		see 167b					see 167b
173c		see 167c					see 167c
		see 167c					see 167c
173d		see 167d					see 167d
		see 167d					see 167d

	Ab2Le	B6C	B10C <sup>a</sup>	B10C <sup>b</sup>	L2Li	T1L	TT319
174a		-244 - - sic				-94a - -	
		see 167a					
174b		see 167b				see 167b -180 - 	see 167b 
		see 167b					see 167b 

	Ab2Le	B6C	B10C <sup>a</sup>	B10C <sup>b</sup>	L2Li	T1L	TT319
(173b)		see 167b					see 167b 
173c		see 167c	-165 - 				see 167c 
		see 167c					see 167c 
		see 167c			... -159 - 		see 167c 
173d		see 167d					see 167d 

	Ab2Le	B6C	B10C <sup>a</sup>	B10C <sup>b</sup>	L2Li	T1L	TT319
175a		-245- 					-95a- 
		<i>see</i> 167a					
175b							
		<i>see</i> 167b					
		<i>see</i> 167b					

	Ab2Le	B6C	B10C <sup>a</sup>	B10C <sup>b</sup>	L2Li	T1L	TT319
(175b)							
		<i>see</i> 167b					<i>see</i> 167b
175c							
		<i>see</i> 167c					<i>see</i> 167c
		<i>see</i> 167c					<i>see</i> 167c
175d							
		<i>see</i> 167d					<i>see</i> 167d

	Ab2Le	B6C	B10C <sup>a</sup>	B10C <sup>b</sup>	L2Li	T1L	TT319
176a	-37- 	-246- 					-96a- 
		see 167a			...		
176b		see 167b		-167- 	...		see 167b
		see 167b					see 167b
	-39- 	see 167b					see 167b

	Ab2Le	B6C	B10C <sup>a</sup>	B10C <sup>b</sup>	L2Li	T1L	TT319
(176b)		see 167b					see 167b
176c		see 167c					see 167c
		see 167c			...		see 167c
176d		see 167d					see 167d
		see 167d			...		see 167d
2*							

1\*  added secondarily?  
 2\* Pyr. 179a follows (Pyr. 177-78 omitted).

	Ab2Le	B6C	B10C <sup>a</sup>	B10C <sup>b</sup>	L2Li	T1L	TT319
177a							 -97a-
177b	 -42- -43-		 sic -168-				 -164- ...
							 see 167b

	Ab2Le	B6C	B10C <sup>a</sup>	B10C <sup>b</sup>	L2Li	T1L	TT319
(177b)							 see 167a
177c	 -44- -45-					 -184-	 see 167c
177d	 -169-		 sic -326-				 see 167d





	Ab2Le	B6C	B10C <sup>a</sup>	B10C <sup>b</sup>	L2Li	T1L	TT319
179a		-237a- 					
179b							

	Ab2Le	B6C	B10C <sup>a</sup>	B10C <sup>b</sup>	L2Li	T1L	TT319
(179b)							
179c							
180a							













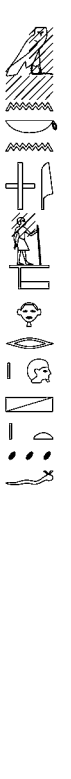

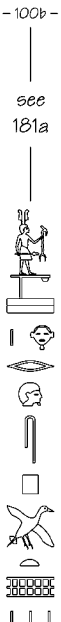
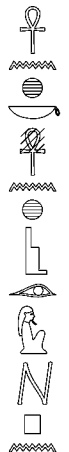

For notes see p. 174.



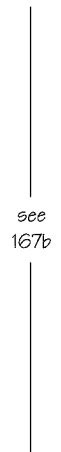





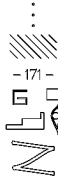

	Ab2Le	B6C	B10C <sup>a</sup>	B10C <sup>b</sup>	L2Li	T9C	T1L	TT319
181a								
181b								

- 1\* See the plan on p. 157.
- 2\* Chiselmarks.
- 3\* Perhaps nothing lost.
- 4\* Uncertain. CTN copy has
- 5\* Cols. 99a-101a are the tops of cols. 99-101, without division lines.
- 6\* This section, completely lost, probably contained Pyr. 181b-d, to be read with Pyr. 181-86: see the plan on p. 157.
- 7\* follows before Pyr. 181c. The scribe apparently began the second couplet of Pyr. 181c before realizing his error and continued without erasing it.

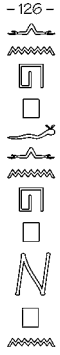

	Ab2Le	B6C	B10C <sup>a</sup>	B10C <sup>b</sup>	L2Li	T9C	T1L	TT319
182a		- 243a - see 181a 			- 170 - 	- 124 - 		- 100b - see 181a 
182b								see 167b
								see 167b

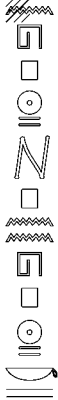
1\* See p. 175 n. 6.

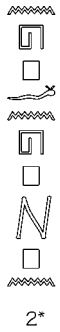
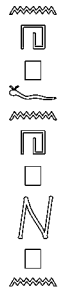
	Ab2Le	B6C	B10C <sup>a</sup>	B10C <sup>b</sup>	L2Li	T9C	T1L	TT319
182c		1*	 <p>ca. 5 groups lost</p>			 <p>-189-</p>	 <p>-189-</p>	<p>see 167c</p>
		1*	 <p>174</p>			 <p>-126-</p>		<p>see 167c</p>
182d		1*				 <p>2*</p>		<p>see 167d</p>

1\* See p. 175 n. 6.  
2\* Pyr. 184 follows.

	Ab2Le	B6C	B10C <sup>a</sup>	B10C <sup>b</sup>	L2Li	T9C	T1L	TT319
183a		<p>- 244a -</p> <p>see 181a</p> <p>sic</p>			<p>...</p>	<p>1*</p>		<p>- 101b -</p> <p>see 181a</p>
183b		<p>2*</p>			<p>...</p> <p>- 172 -</p>			<p>see 167b</p>
		<p>2*</p>			<p>...</p> <p>- 172 -</p>	<p>- 190 -</p>		<p>see 167b</p>
			<p>ca. 6 groups lost</p>					

1\* Pyr. 184 precedes.  
 2\* See p. 175 n. 6.

	Ab2Le	B6C	B10C <sup>a</sup>	B10C <sup>b</sup>	L2Li	T9C	T1L	TT319
183c		<p>1*</p>				<p>-132-</p>		<p>see 167c</p>
		<p>1*</p>			<p>3*</p>	<p>-133-</p>		<p>see 167c</p>
		<p>2*</p>			<p>-175-</p>			
183d	<p>End of col. and Lid</p>	<p>1*</p>						<p>see 167d</p>
		<p>1*</p>						<p>4*</p>

Notes to p. 181:

1\* Traces: .

2\* Pyr. 182 precedes.

3\* .

4\* See p. 175 n. 6.

5\* Pyr. 183 follows.

1\* See p. 175 n. 6.

2\* Perhaps nothing lost.

3\* Group with end of preceding N.

4\* Pyr. 185 follows.



	B6C	B10C <sup>a</sup>	B10C <sup>b</sup>	L2Li	T9C	T1L	TT319
184a	-245a- see 181a 			... -173- 	-127- 2* 		-102a- see 181a 
184b	4* 				3* End of col. and Front 		
184c	4* 						see 167b 
	4* 						see 167b 

	B6C	B10C <sup>a</sup>	B10C <sup>b</sup>	L2Li	T9C	TT319
184d	4* 			... -174- 		see 167c 
	4* 					see 167c 
184e	ca. 7 groups lost ... -176- 				-130- 	5* see 167d 
	4* 					

For notes see p. 180.



	B6C	B10C <sup>a</sup>	B10C <sup>b</sup>	L2Li	T9C <sup>a</sup>	T9C <sup>b</sup>	TT319
186a	-247a- see 181a				-137- 		-104a- 
186b					-146- 		-105a- 
186c					-138- 		

	B10C <sup>a</sup>
186b bis	
186c bis	

1\*

2\* See p. 191.

3\* Pyr. 147a-48a follows (see p. 97 n. 5), then a repeat of Pyr. 167a-d (T9C<sup>b</sup>), then Pyr. 185-86 (T9C<sup>b</sup>) and the remainder of PT 219.

4\* Text at right follows before Pyr. 187a.

	B6C	B10C <sup>a</sup>	B10C <sup>b</sup>	L2Li	T9C	TT319
187a						
	1*					see 167b
	1*					see 167b
187b						
	1*					see 167c

	B6C	B10C <sup>a</sup>	B10C <sup>b</sup>	L2Li	T9C	TT319
(187b)						
	1*	ca. 8 groups lost	sic			see 167c
187c						
	1*					see 167d
188a						
	see 181a					
188b						

1\* See p. 175 n. 6.

	B6C	B10C <sup>a</sup>	B10C <sup>b</sup>	L2Li	T9C	TT319
(188b)						
188c						
188d						













	B6C	B10C <sup>a</sup>	B10C <sup>b</sup>	L2Li	T9C	TT319
(188d)						
188e						
189a						



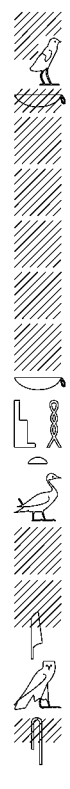

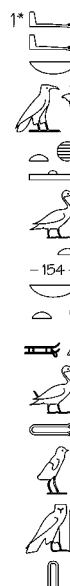







1\* Probably nothing lost.  
 2\* Hieroglyphic sign.

	B6C	B10C <sup>a</sup>	B10C <sup>b</sup>	L2Li	T9C	TT319
189b						
189c						



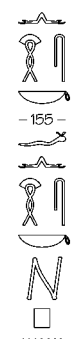

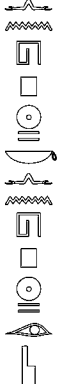
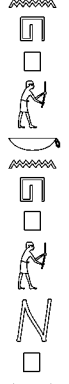

	B6C	B10C <sup>a</sup>	B10C <sup>b</sup>	L2Li	T9C	TT319
189d						
189e						





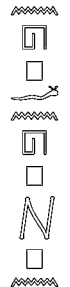



1\* Probably nothing lost.

	B6C	B10C <sup>a</sup>	B10C <sup>b</sup>	L2Li	T9C	TT319
190a	-241a- — see 181a — 					
190b						
190c	—			—		— see 167b

	B6C	B10C <sup>a</sup>	B10C <sup>b</sup>	L2Li	T9C	TT319
(190c)						— see 167b
190d						— see 167c
						— see 167c

1\*   
 2\* Probably nothing lost.

	B6C	B10C <sup>a</sup>	B10C <sup>b</sup>	L2Li	T9C	TT319
190e						
						see 167d
191a						
	see 190a		see 190a			

	B6C	B10C <sup>a</sup>	B10C <sup>b</sup>	L2Li	T9C	TT319
191b						
	see 190b		see 190b			
191c						
	see 190c		see 190c			see 167b
						
	see 190c		see 190c			see 167b



	B6C	B10C <sup>a</sup>	B10C <sup>b</sup>	L2Li	T9C	TT319
191d	— see 190d		— see 190d			— see 167c
	— see 190d		— see 190d			— see 167c
191e	— see 190e		— see 190e			— see 167d

1\* Probably nothing lost.  
 2\*   
 3\* Group with following.  
 4\* added secondarily.

	B6C	B10C <sup>a</sup>	B10C <sup>b</sup>	L2Li	T9C	TT319
192a				—		
192b						

	B6C	B10C <sup>a</sup>	L2Li	T9C	TT319
192c					
					see 167b
					see 167b
					see 167c
					see 167c

	B6C	B10C <sup>a</sup>	L2Li	T9C	TT319
192e					
					see 167d
193a					
193b					

For note see p. 191.





Sed2 Cop	Sed1 Sed	Sq2Be	Sq5C	Sq9C	Sq10C	Sq1Ch	Sq1Cop	T4Be	T1C	T9C	TT240	TT319
-1- 	-(211)-	-10-	-14-	-1-	-(133)-	-1- 	-1-	-18-	-213-	-(163)-	-1-	-114-
194a												

1\* Under B 2-15 (PT 220-221 beginning).

2\* Group with following.

194b

194c

	B2Bo	B3Bo	B4Bo	B6Bo	B10Ca	B10Cb	BH1C	BH3C	BH5C	BH20x	L-A1	L1NY	M1Ca	M1Cb	Sed1 Cop
194b						 1* ca. 15 groups lost				 -37- 4*		 -E2- 5*	 -79- -226-		 -15- -16-
				—		 ca. 5½ groups lost				 -46- -56-					 -17-
194c			—									 -E3-		—	 -18- -19-
										 -58- -39-	 -B4-		 -80- -227-		 -20-

For notes see p. 199.

194b

Sed2 Cop	Sed1 Sed	Sq2Be	Sq5C	Sq9C	Sq10C	Sq1Ch	Sq1Cop	Sq1Sq	T4Be	T1C	T9C	TT240	TT319
	-212- 		-15- 						-19- 				

194c



	B2B0	B3B0	B4B0	B6B0	B10C <sup>a</sup>	B10C <sup>b</sup>	BH1C	BH5C	BH20x	L-A1	L1NY	M1C <sup>a</sup>	M1C <sup>b</sup>	Sed1 Cop	Sed2 Cop
194d				 sic	 ... ca. 33 groups lost		-51- 	-49- 	2* 					-21- 	-6- 
							 sic	 sic						-22- 	 sic
195a						-387- 		-50- 			-E4- 				
								-40- 							
									4* 						
195b															
														-25- 	



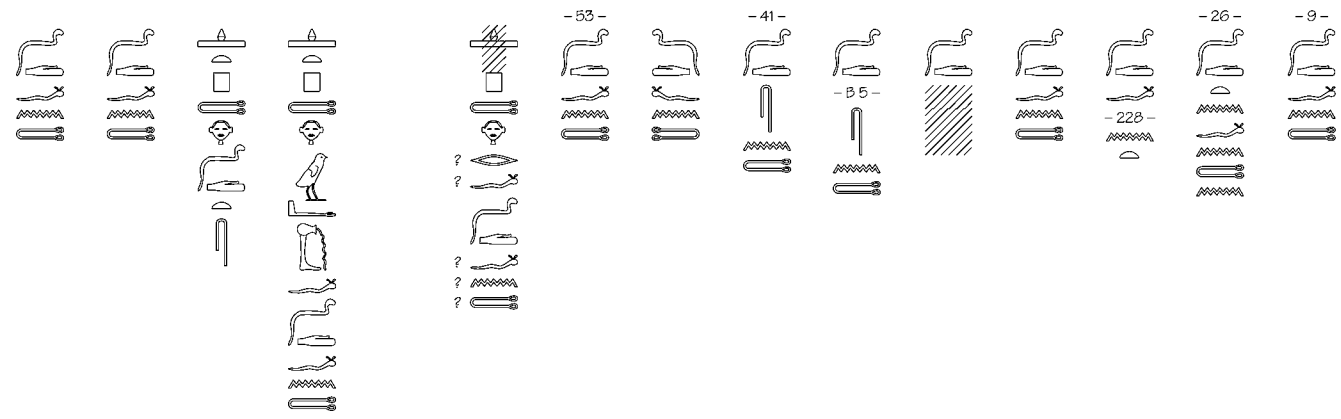

(195b)

B2Bo B3Bo B4Bo B6Bo B10Ca B10Cb BH1C BH5C BH20x L-A1 L1NY MICa MICb Sed1 Cop Sed2 Cop



195c

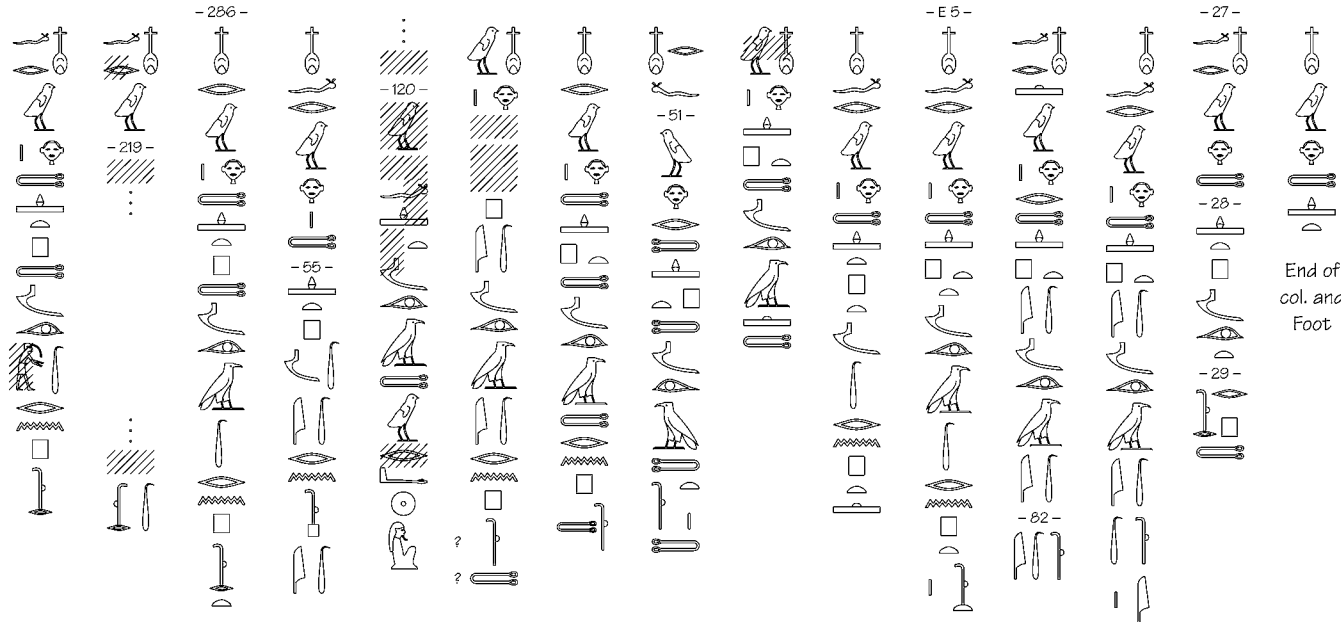

End of col. and Foot

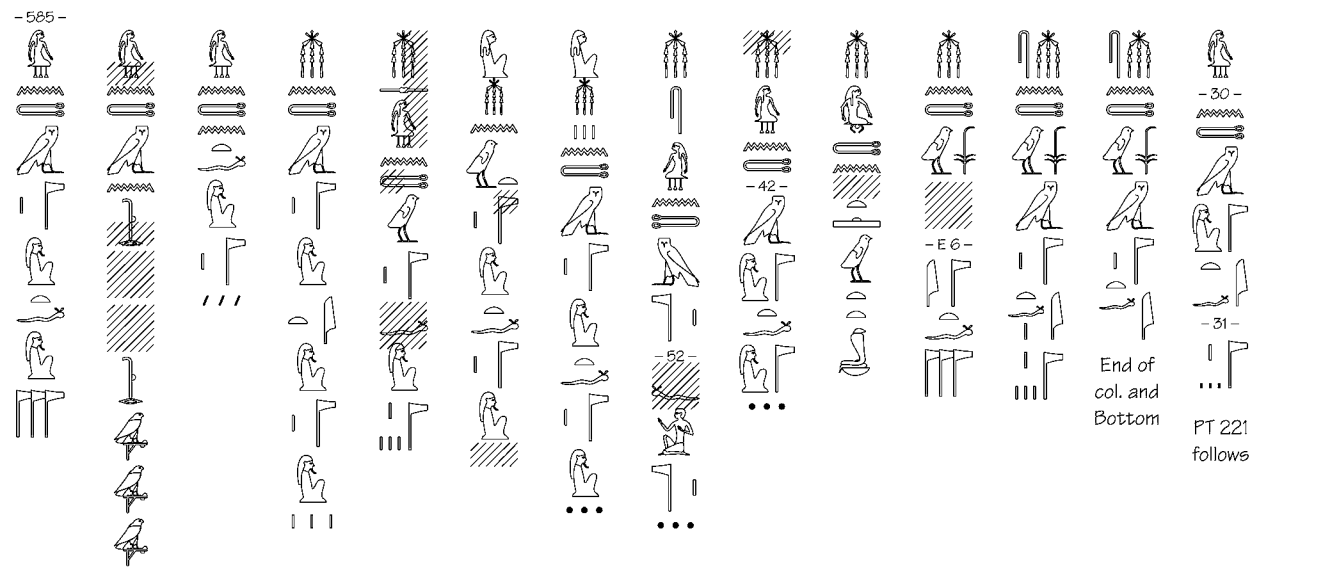

End of col. and Bottom

PT 221 follows

Sq2Be Sq5C Sq9C Sq10C Sq1Ch Sq1Sq T4Be T1C T9C TT240

(195b)

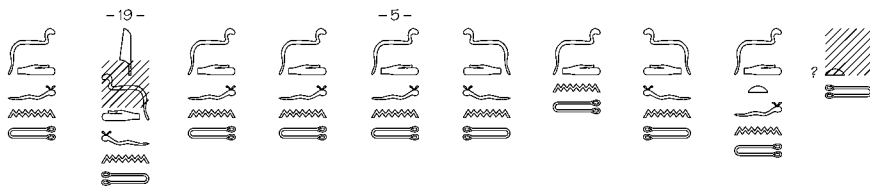

195c

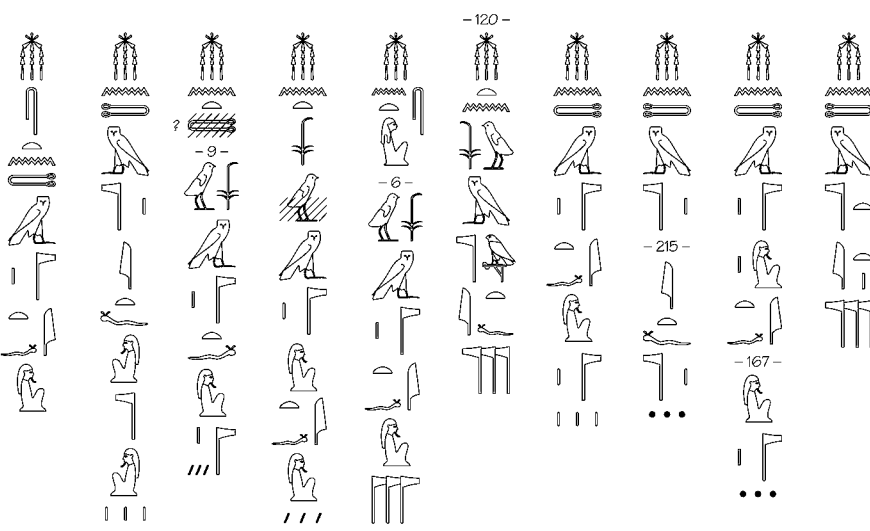
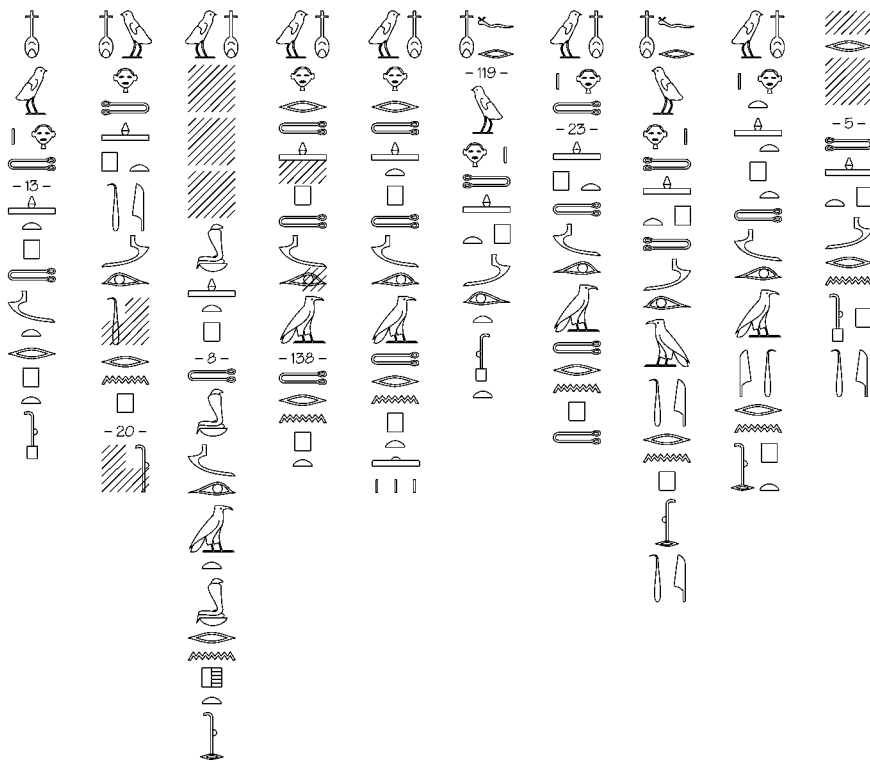

PT 222 follows

Notes to pp. 194-95:

- 1\* Corrected over
- 2\* added secondarily.
- 3\* Reed-leaf corrected next to an erasure (probably ).
- 4\* 3 groups left blank (for N).
- 5\* Group with preceding.
- 6\* Group with following.
- 7\* Text on p. 197 follows before Pyr. 194d.
- 8\* nj added secondarily.
- 9\* Pyr. 195e follows.



Sq2Be Sq5C Sq9C Sq1Ch Sq1Cop Sq1Sq T4Be T1C T9C TT240

195d

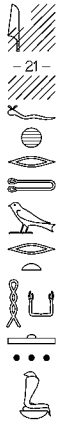
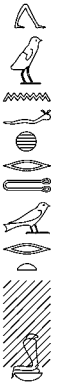

PT 221 follows

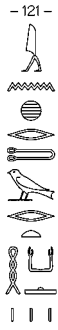

-121-



-24-



195e

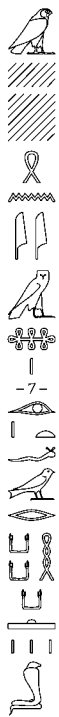
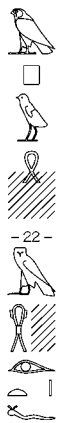

-122-

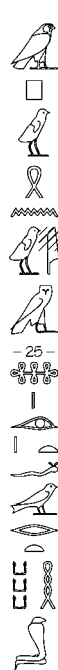

-25-



-123-



-7-



-25-

PT 221 follows

PT 221 follows

PT 221 follows

PT 221 follows

PT 221 follows

PT 221 follows

PT 221 follows

PT 221 follows

PT 221 follows



	Sed1 Cop	Sed1 Sed	Sq2Be	Sq5C	Sq9C	Sq1Cop	Sq1Sq	T4Be	T1C	T9C	TT240
196a	- (31) - 	- (213) - 	- (14) - 	- (22) - 	- (11) - 	- (123) - 	- (25) - 	- (215) - 	- 168 - 	- (6) - 	- (6) - 
196b	- 33 - 	- 33 - 	- 15 - 	- 23 - 	- 9 - 	- 125 - 	- 126 - 	- 9 - 	- 9 - 	- 9 - 	- 9 - 

1\* Pyr. 198a precedes.  
 2\* Pyr. 198b follows.  
 3\* Chiselmarks:

4\* Chiselmarks:

5\* Chiselmarks:

6\* Chiselmark:

7\* Remainder of col. lost.  
 Pyr. 197c follows in col. 33.

8\* Corrected over

9\* Second canceled by 2 strokes.

10\* Remainder lost. PT 222 (Pyr. 202b) continues after a gap of 13 cols.















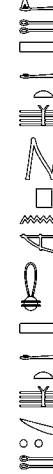
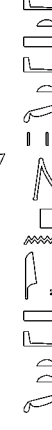
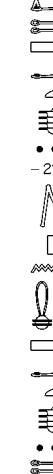

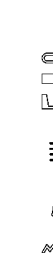
	B2Bo	B3Bo	B4Bo	B6Bo	B10C <sup>a</sup>	B10C <sup>b</sup>	BH1C	BH3C	BH5C	L-A1	L3Li	L1NY	M1C	Sed1 Cop	Sq2Be
197a															
197b															
197c															

ca. 16 groups lost

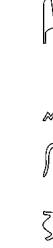
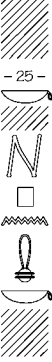
2\*  
-(33)-  
...

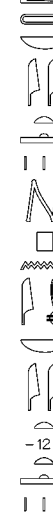
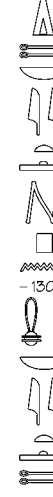
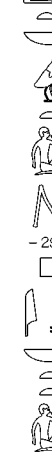
sic



	Sq5C	Sq9C	Sq1Ch	Sq1Cop	Sq1Sq	T4Be	T1C	TT240	TT319
197a	 -24-	 -13-	 -7-		 -127-	 -27-	 -216-		
197b		—	—	—	 -128- sic	 -28-	—	 -8-	
197c	 -25-	 -14- -15-	 -8-	 -11-	 -130-	 -29-	 -129-		 -118-

1\* št added to right of N pn.  
2\* PT 356 precedes.

197d

197e

	B2Bo	B3Bo	B4Bo	B6Bo	B10C <sup>a</sup>	B10C <sup>b</sup>	BH1C	BH3C	BH5C	L-A1	L3Li	L1NY	M1C	Sed1 Cop	Sq2Be
197d															
197e															

ca. 10½ groups lost

ca. 13 groups lost

-34-

-35-

-E 12-

-42-

-44-

-46-

sic

-45-

-47-

-588-

-221-

-588-

-56-

-56-

-589-

-60-

-59-

-59-

3\*

-104-

-57-

-58-

-B 10-

-59-

-E 11-

	Sq5C	Sq9C	Sq1Ch	Sq1Cop	Sq1Sq	T4Be	T1C	TT240	TT319
197d	<p>6 groups lost</p>								
197e	<p>7 groups lost</p>								
	<p>-27-</p>	<p>-17-</p>	<p>-10-</p>	<p>-15-</p>	<p>-133-</p>	<p>-31-</p>			<p>-119-</p>

1\* Suffix *f* and *mj kyt* to left of and following, apparently added secondarily.

2\* Chiselmarks:

3\* Added secondarily to left of preceding plural dots.



	Sq5C	Sq9C	Sq1Ch	Sq1Cop	Sq1Sq	T4Be	T1C	TT240	TT319
197f	<p>...</p> <p>-36-</p> <p>...</p> <p>...</p>						<p>-217-</p>		<p>End of col. and Back</p>
198a	<p>?</p>	<p>-19-</p> <p>4*</p> <p>PT 222 follows</p>	<p>5*</p> <p>-11-</p>	<p>-16-</p> <p>6*</p>				<p>-11-</p>	

1\*  $\triangle$  added secondarily.

2\* wr apparently intentional:

3\* jm crowded in at end of col. Title on p. 202 follows in col. 19 before Pyr. 198b.

4\*  $\triangle$  added secondarily.

5\* Sic: 1/2 group left blank.

6\* Traces to the right of , not

	B2B <sub>0</sub>	B3B <sub>0</sub>	B4B <sub>0</sub>	B6B <sub>0</sub>	B10C <sup>a</sup>	B10C <sup>b</sup>	BH1C	BH3C	BH5C	L-A1	L3Li	L1NY	M1C	Sed1 Cop	Sq2Be
198b															
					PT 222 follows										9-10 groups lost
198c															



	B2Bo	B3Bo	B4Bo	B6Bo	B10C <sup>b</sup>	BH1C	BH3C	BH5C	L-A1	L3Li	L1NY	M1C	Sed1 Cop	Sq2Be	Sq1Ch
198d															
	PT 222 follows	PT 222 follows	PT 222 follows	PT 222 follows	PT 222 follows	PT 222 follows	PT 222 follows	PT 222 follows	PT 222 follows	PT 222 follows	PT 222 follows	PT 222 follows	End of col. and Back	PT 222 follows	PT 222 follows

PT 222

	B2Bo	B3Bo	B4Bo	B6Bo	B10C <sup>a</sup>	B10C <sup>b</sup>	BH1C	BH3C	BH5C	BH20x	L-A1	L3Li	L1NY	M1C	M25C
199a															
	- (589) -	- (222) -	- (291) -	- (60) -	- (122) -	- (390) -	- (65) -	- (106) -	- 62 -	- (43) -	- B 16 -	- (40) -	- (E 15) -	- 91 -	- 53 -



	Sq1Cop	Sq1Sq	T4Be	T1C	TT240
198d					
	PT 222 follows	PT 222 follows	PT 222 follows	PT 222 follows	PT 222 follows

PT 222

	Sq2Be	Sq9C	Sq10C	Sq1Ch	Sq1Cop	Sq1Sq	T4Be	T1C	TT240
199a	- (20) -	- (19) -	- 139 -	- (14) -	- (20) -	- (136) -	- 34 -	- (217) -	- (13) -

1\* added secondarily.  
 2\* added secondarily.  
 3\* Under cols. B 17-29.

B2B0 B3B0 B4B0 B6B0 B10C<sup>a</sup> B10C<sup>b</sup> BH1C BH3C BH5C BH20x L-A1 L3Li L1NY MIC M25C

(199a)

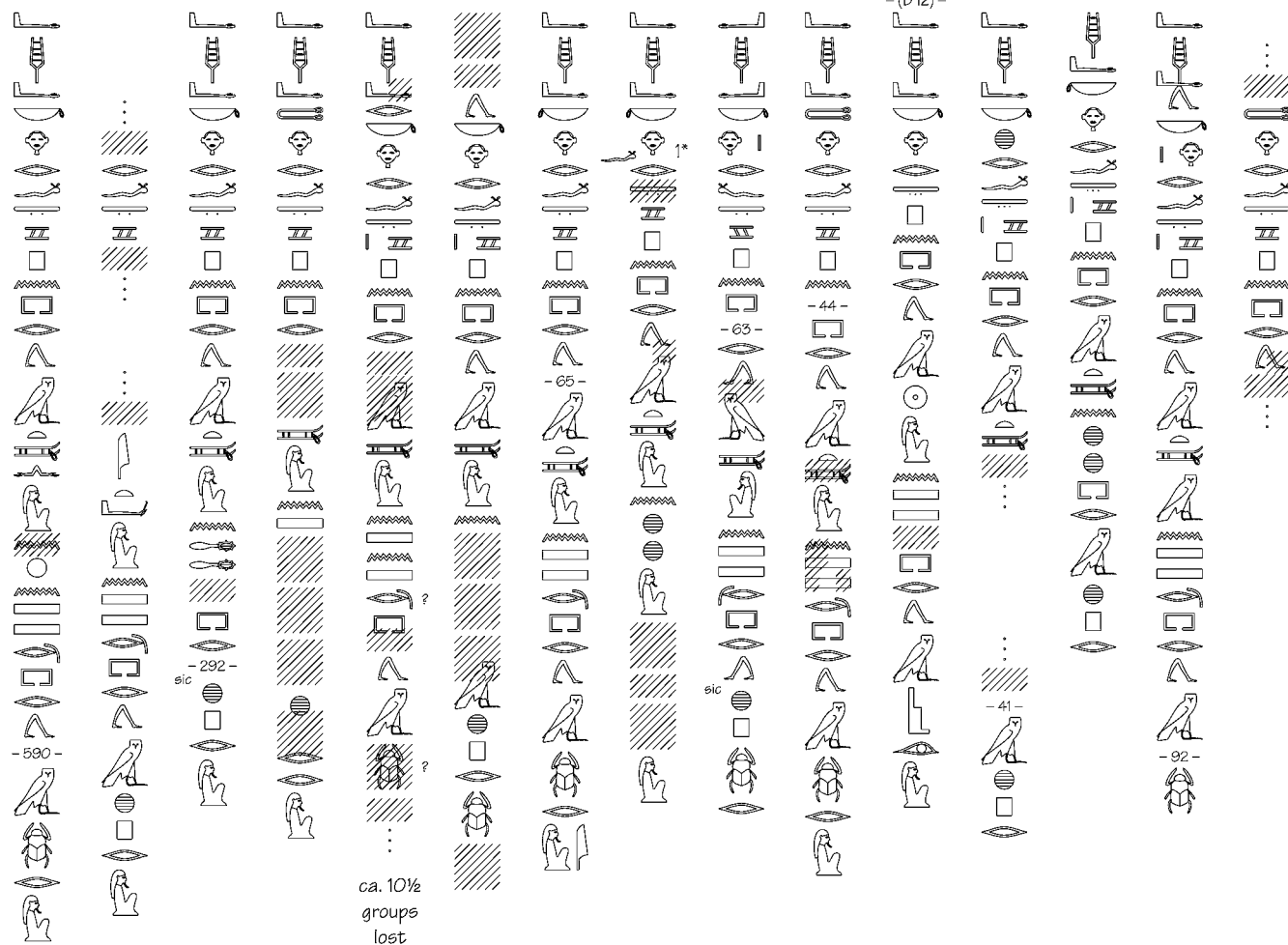

199b

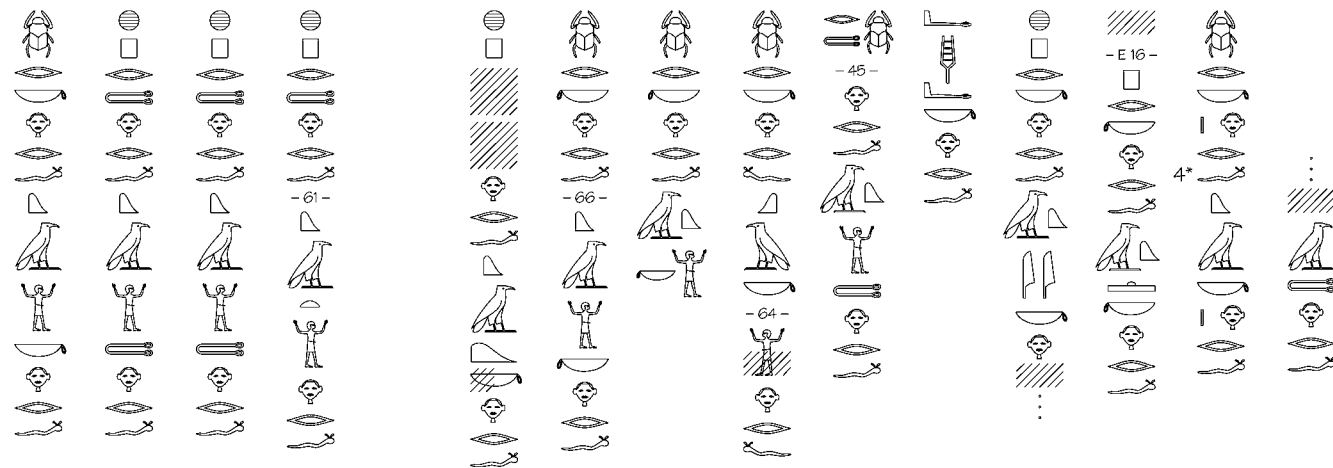

Sq2Be Sq9C Sq10C Sq1Ch Sq1Cop Sq1Sq T4Be T1C TT240

(199a)

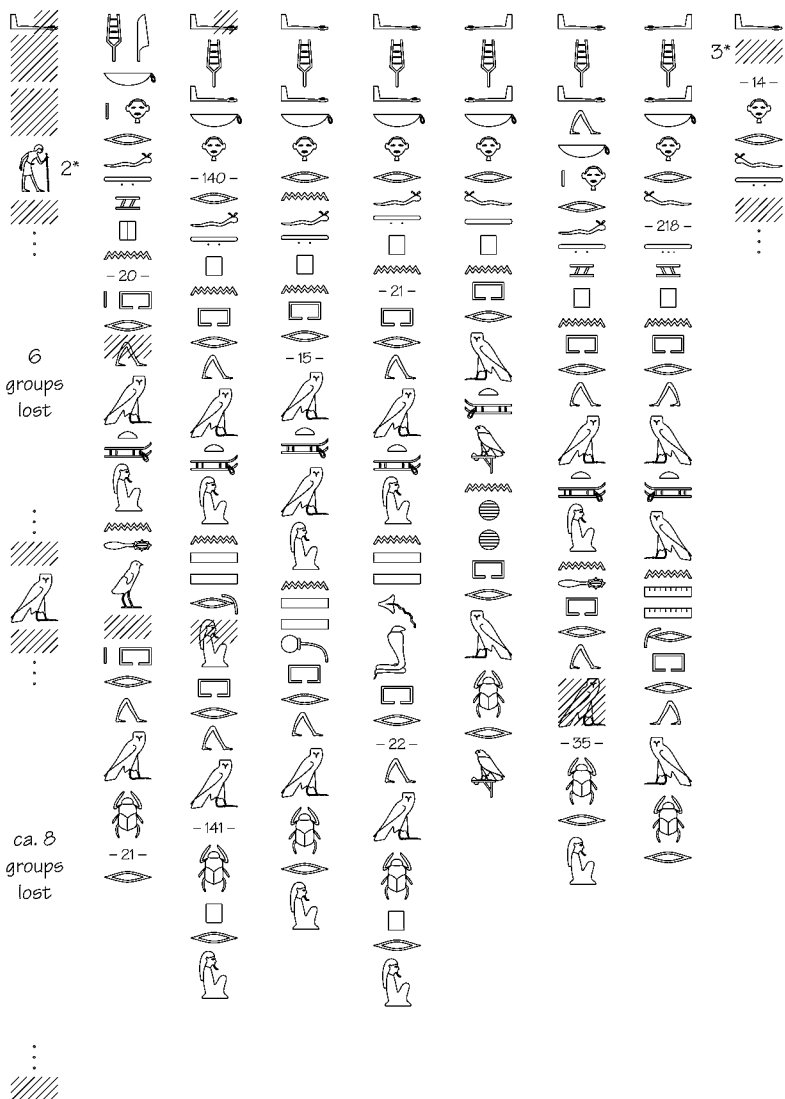

199b

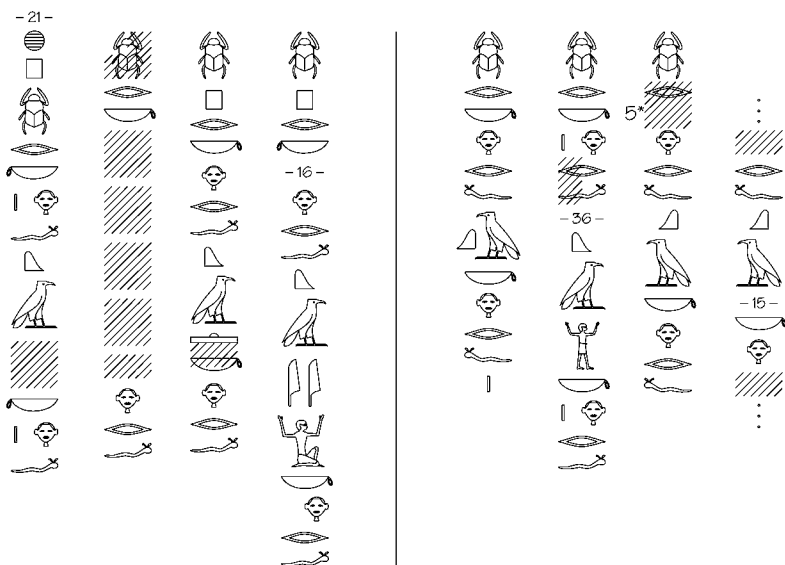

- 1\* added secondarily.
- 2\* Part of N [pn]?
- 3\* Sic: "no more space" (AdB).
- 4\* corrected over erased .
- 5\* recorded by Maspero, with no , but there is just enough room for .

199c

B2B0	B3B0	B4B0	B6B0	B10C <sup>a</sup>	B10C <sup>b</sup>	BH1C	BH3C	BH5C	BH20x	L-A1	L3Li	L1NY	MIC	M25C

ca. 5 groups lost

200a

--	--	--	--	--	--	--	--	--	--	--	--	--	--	--

3\*

123

391

4\*

55

47

B14

43

E18a

3\*

95

5\*

94

2\*

54

107

46

42

93

E17

Sq2Be Sq9C Sq10C Sq1Ch Sq1Cop Sq1Sq T4Be T1C TT240

199c



200a

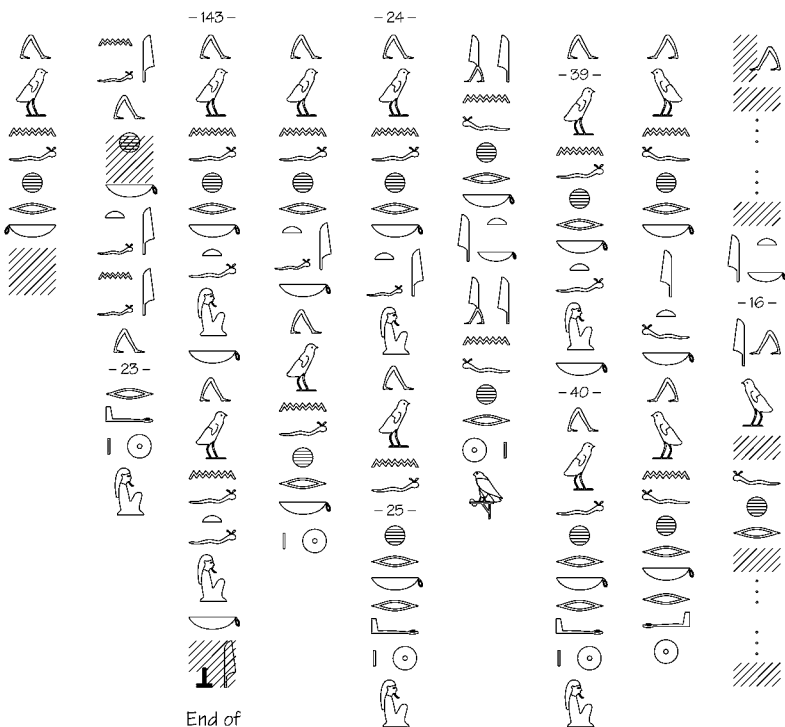

End of col. and Lid

Plan of B6Bo 62-78

62							
63	64	65	66	67	68	69	70
71	72	73	74	75	76	77	78

Plan of L1NY E 18a-25b

18a	19a	20a	21a	22a	23a	24a	25a
18b	19b	20b	21b	22b	23b	24b	25b

Plan of M1C 94-102a

94							
102	101	100	99	98	97	96	95
102a	101a	100a	99a	98a	97a	96a	95a

- 1\* *jm3[hw/y]t m3[<sup>c</sup>]t hrw N.*
- 2\* Ca. 1/2 col. blank to end of col.
- 3\* See plan above.
- 4\* Corrected over
- 5\* End of frag. c. Cols. 55-60 on frag. b, beginning with Pyr. 200d.





200a

B2B0 B3B0 B4B0 B6B0 B10C<sup>a</sup> B10C<sup>b</sup> BH1C BH3C BH5C BH20x L-A1 L3Li L1NY MIC M25C

--	--	--	--	--	--	--	--	--	--	--	--	--	--	--

201a

--	--	--	--	--	--	--	--	--	--	--	--	--	--	--





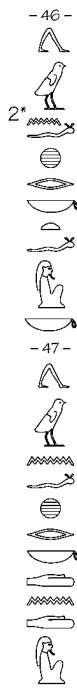

Sq2Be Sq9C Sq1Ch Sq1Cop Sq1Sq T4Be T1C TT240

200d

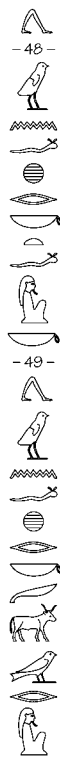
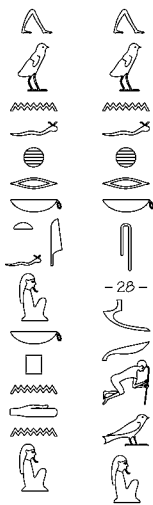

201a



1\*  corrected over .  
2\*  added secondarily.

	B2B <sub>0</sub>	B3B <sub>0</sub>	B4B <sub>0</sub>	B6B <sub>0</sub>	B10C <sup>a</sup>	B10C <sup>b</sup>	BH1C	BH3C	BH5C	BH20x	L-A1	L3Li	L1NY	M1C	M25C
201b				 see 200a 							 - B 18 -	 - 46 -	 see 200a 	 see 200a 	 - 57 -
201c		 - 224 -		 see 200a 								 - 47 -	 see 200a 	 see 200a 	 - 101 -

Sq2Be Sq9C Sq1Ch Sq1Cop Sq1Sq T4Be T1C TT240

201b

		 -21-  -29- 	 -29- 	 -50-  -51- 	 -220- 	 
--	--	--------------------------	--------------	--------------------------	---------------	------

201c

 	 -25- 	  -22-  -30- 	 	 -52-  -53- 	 	 -18-   ...
------	--------------	------------------------------	------	--------------------------	------	-------------------------

End of col. and Foot

1\*  $\beta$  added secondarily.  
2\* (j)t.k added secondarily.

	B2B <sub>0</sub>	B3B <sub>0</sub>	B4B <sub>0</sub>	B6B <sub>0</sub>	B10C <sup>a</sup>	B10C <sup>b</sup>	BH1C	BH3C	BH5C	BH20x	L-A1	L3Li	L1NY	M1C	M25C
201d			 -295-	 see 200a	 ca. 11 groups lost		 -73-		 -69-			 -48- see 200a	 -E 25a- see 200a	 -102- see 200a	 -58- sic
202a					 ca. 11½ groups lost		 -74-		 -70-	 -52- 2*	 -B 19- 3*	 -49- -E 18- 3*	 -95a- -96a- -97a-		 -59-

Sq2Be	Sq9C	Sq1Ch	Sq1Cop	Sq1Sq	T4Be	T1C
-------	------	-------	--------	-------	------	-----

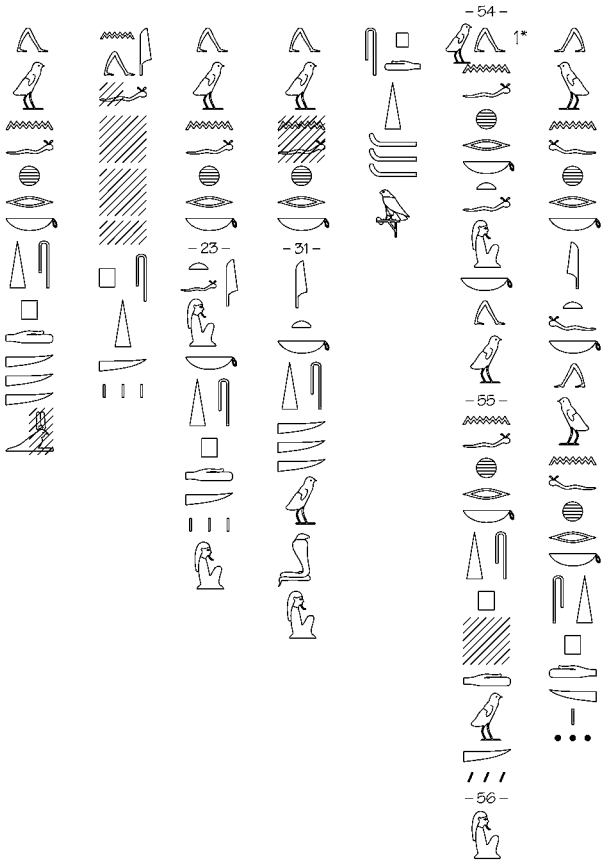

201d

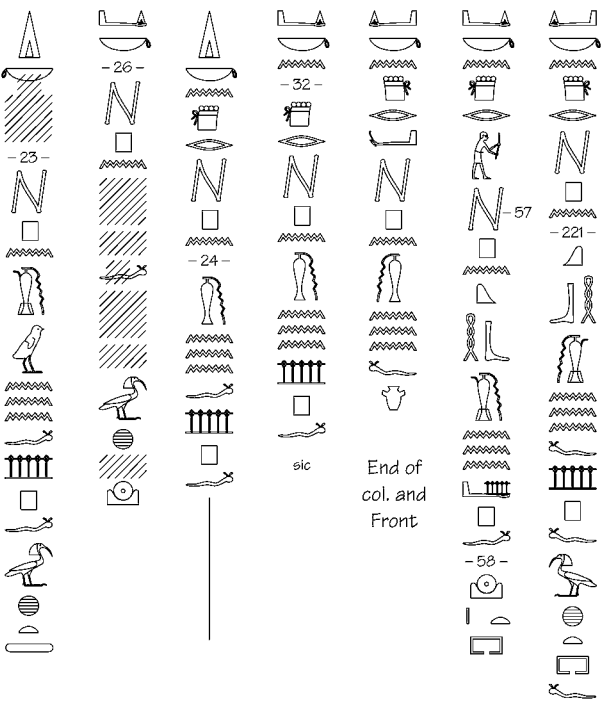

202a



sic  
End of  
col. and  
Front

1\*  added secondarily.  
 2\* 2½ groups left blank (for N).  
 3\* Publication has  for .



	Sed1Sed	Sq2Be	Sq9C	Sq1Ch	Sq1Cop	T4Be	T1C
202b	<p>1*</p> <p>-228-</p>				<p>-33-</p>	<p>-59-</p>	
202c	<p>6 groups lost</p>	<p>5* -27-</p> <p>-24-</p>	<p>5* -27-</p>		<p>-60-</p>	<p>-35-</p>	

1\* Preceding 13 cols. lost.  
 2\* m<sup>c</sup> added secondarily.  
 3\* 2½ groups left blank (for N).  
 4\* End of frag. c; remainder lost.  
 5\* Perhaps ½ group lost at end of col. 26 and beginning of col. 27.

B2Bo B3Bo B4Bo B6Bo B10C<sup>a</sup> B10C<sup>b</sup> BH1C BH3C BH5C BH20x L-A1 L3Li L1NY MIC Sed1Sed

(202c)

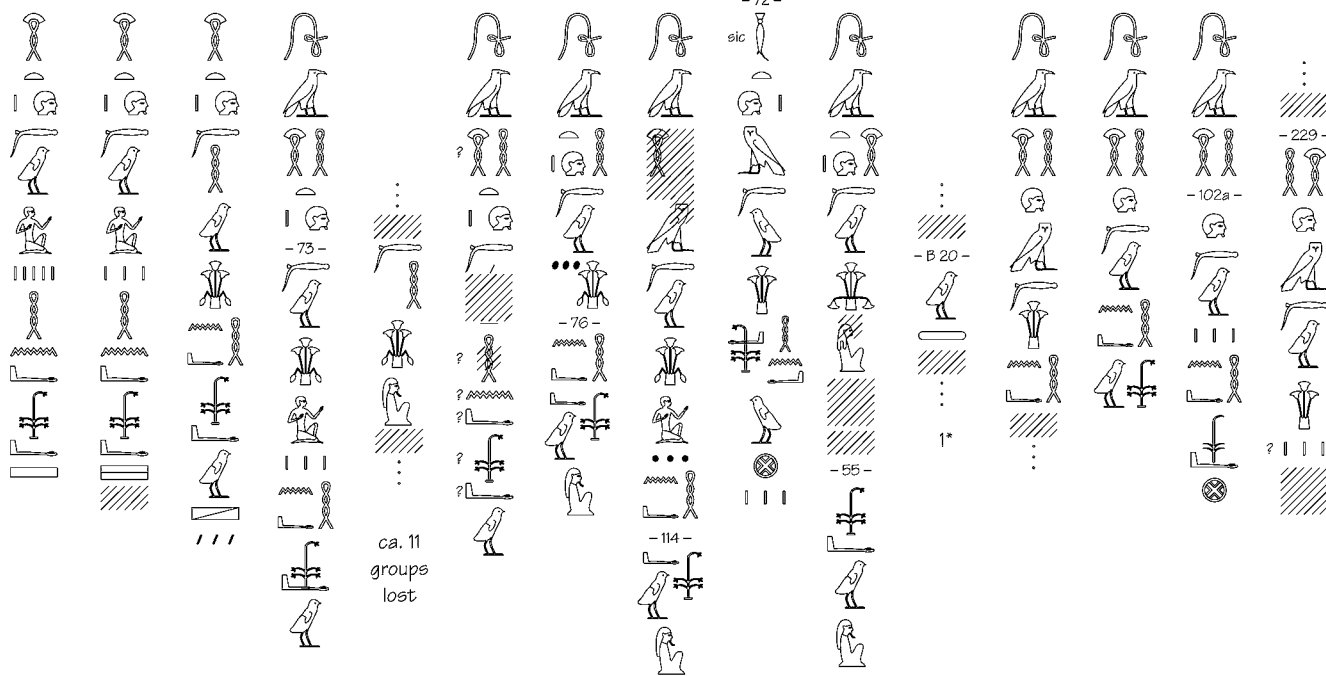

203a

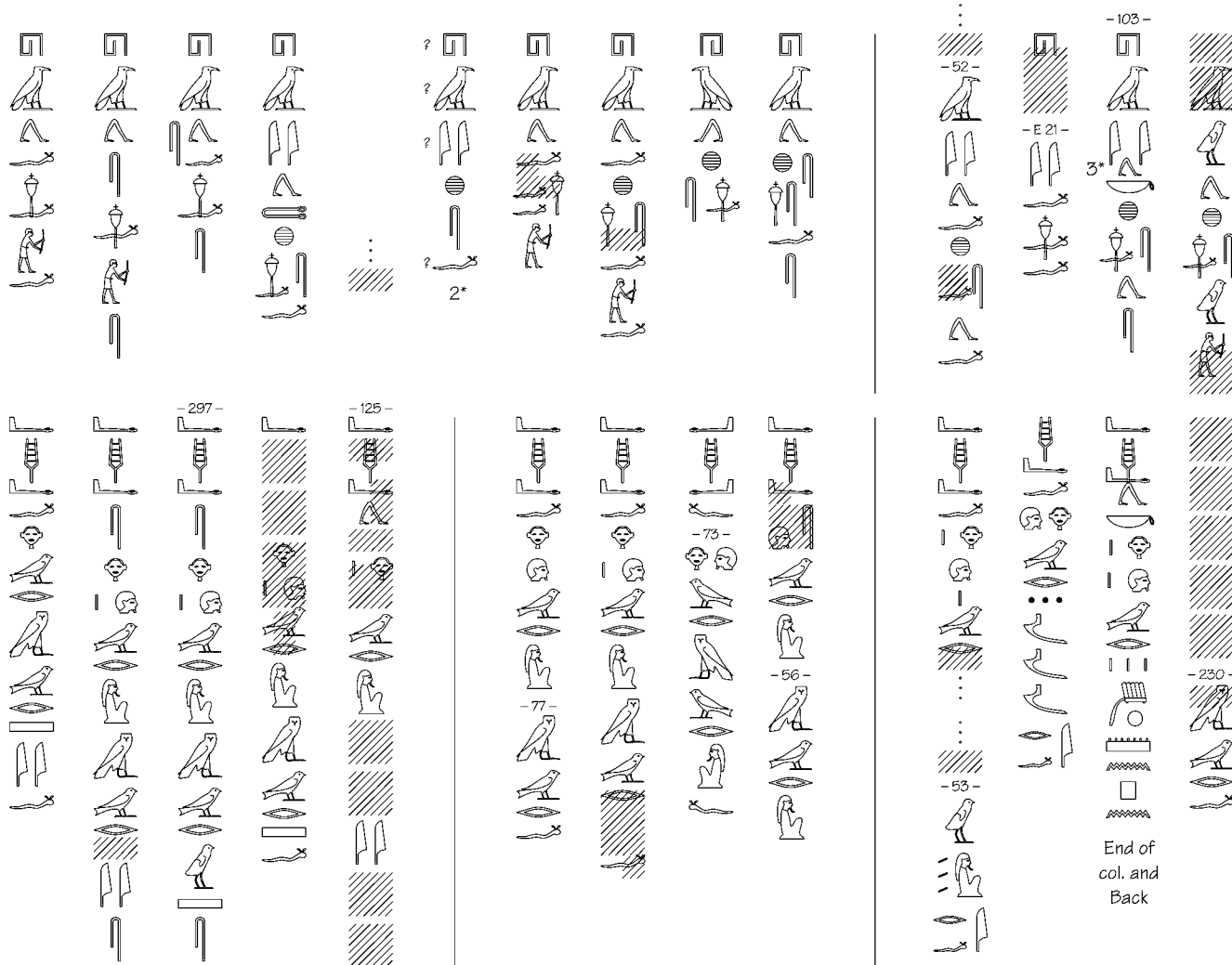



	Sq2Be	Sq9C	Sq1Ch	Sq1Cop	T4Be	T1C
(202c)						
203a	 4 groups lost	 -28- 4½ groups lost	 -26- 4*		 -63- 5*	 -222- 5*

Sq1Ch
207c

1\* Pyr. 204b follows.  
 2\* Pyr. 205b follows.  
 3\* added secondarily.  
 4\* From Pyr. 207b. Text above follows before Pyr. 203b.  
 5\* Maspero copy , but photo suggests as in Sq2Be.

B2Bo B3Bo B4Bo B6Bo B10C<sup>a</sup> B10C<sup>b</sup> BH1C BH3C BH5C BH20x L-A1 L3Li L1NY Sed1Sed Sq2Be

203b

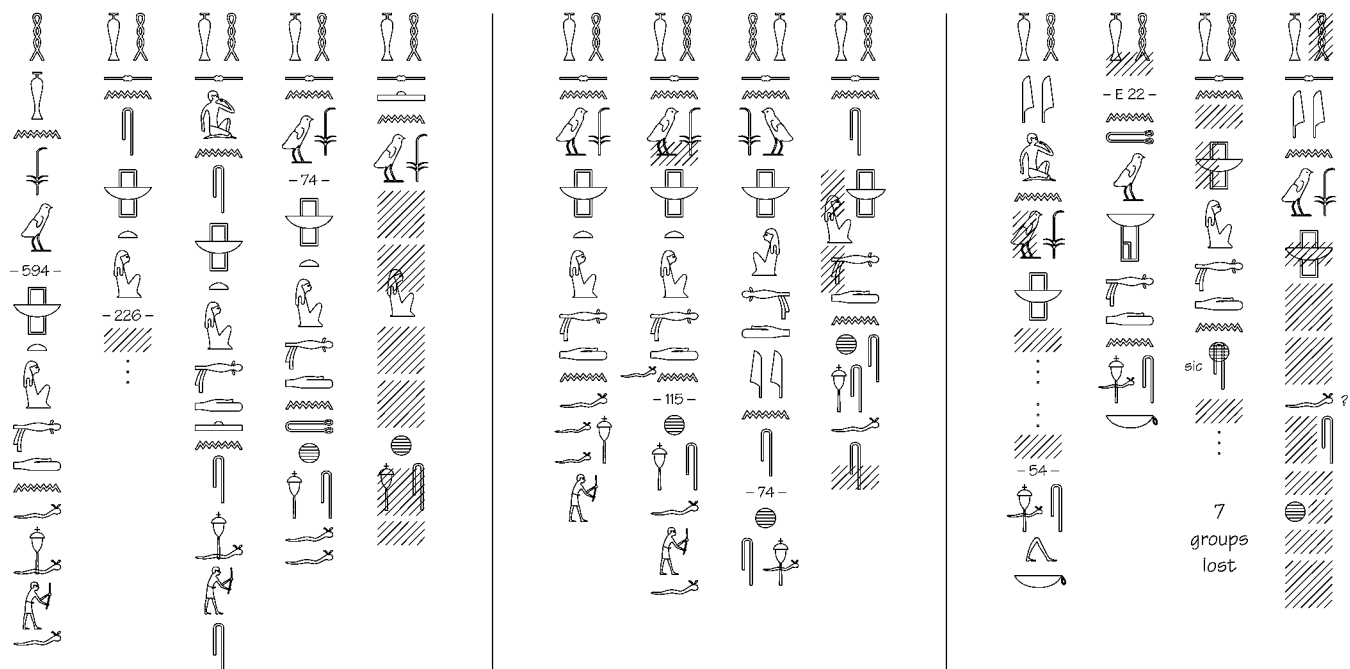

204a



	Sq9C	Sq1Ch	Sq1Cop	T4Be	T1C
203b					
204a					
	<p>6½ groups lost</p>				

1\* Publication : "must be " (AdB).  
 2\* Publication .  
 3\* corrected over .  
 4\* Group with following.

B2Bo B3Bo B4Bo B6Bo B10C<sup>a</sup> B10C<sup>b</sup> BH1C BH3C BH5C BH20x L-A1 L3Li L1NY Sed1Sed Sq2Be

204b

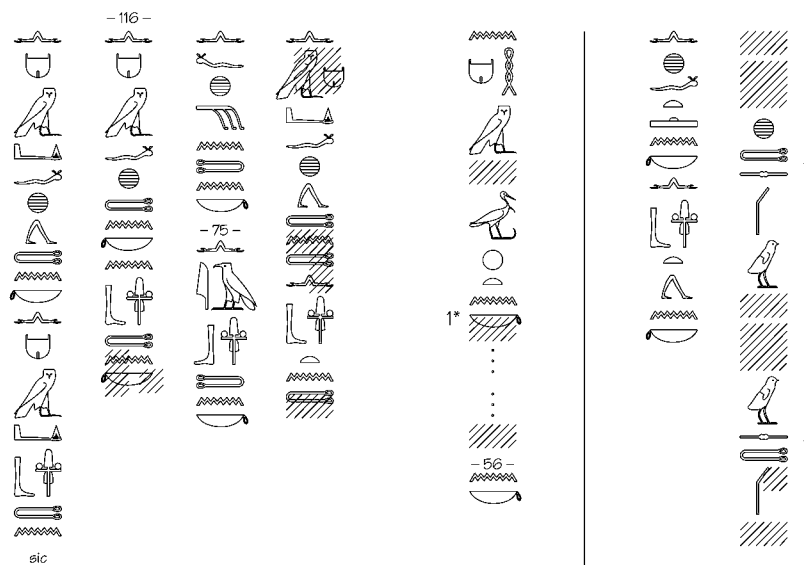
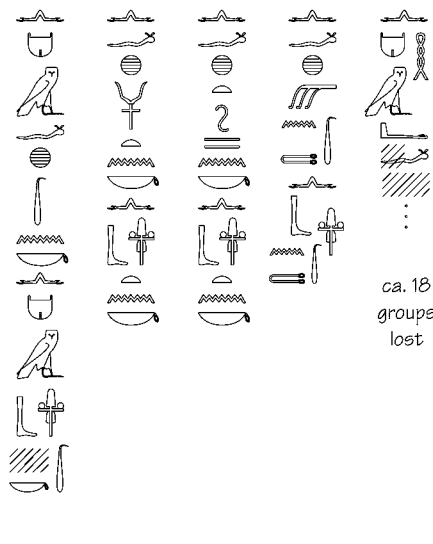

204c

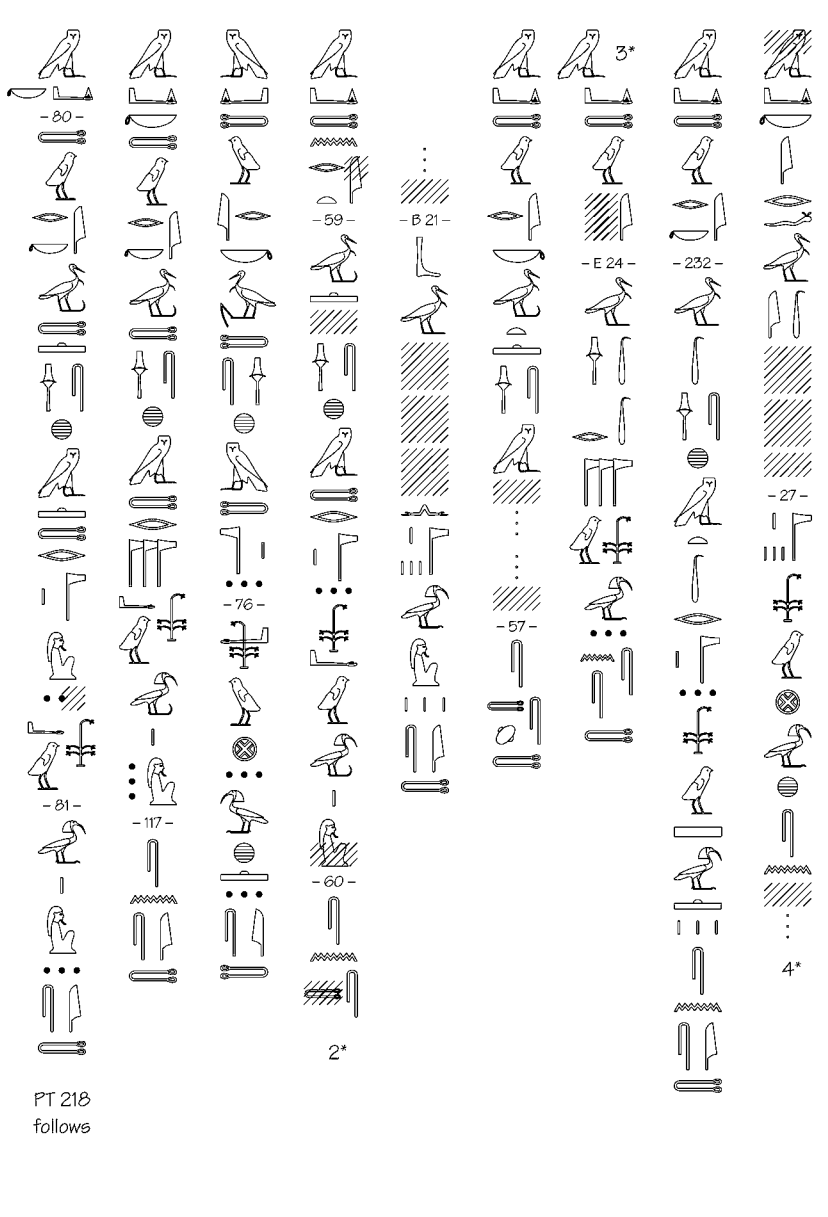
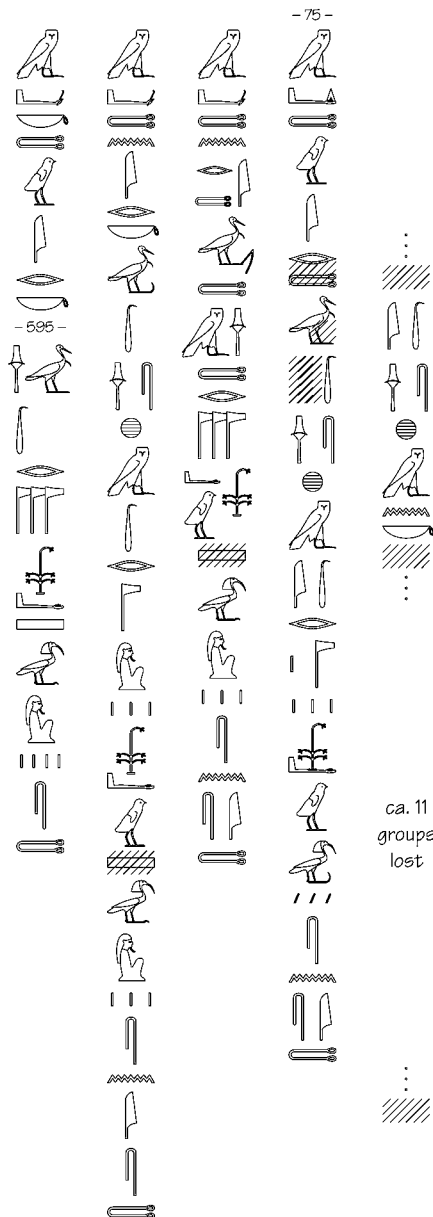



	B2Bo	B3Bo	B4Bo	B6Bo	B10C <sup>a</sup>	B10C <sup>b</sup>	BH3C	BH5C	BH20x	L-A1	L3Li	L1NY	Sed1Sed	Sq9C	Sq1Ch
205a															
205b															

	T4Be	T1C
205a	-72-	
205b		
	-74-	

1\* So CTN—read ?  
 2\* added secondarily.

B2B0 B3B0 B4B0 B6B0 B10C<sup>a</sup> B10C<sup>b</sup> BH3C BH5C BH20x L-A1 L3Li L1NY Sed1Sed Sq9C Sq1Ch

206a

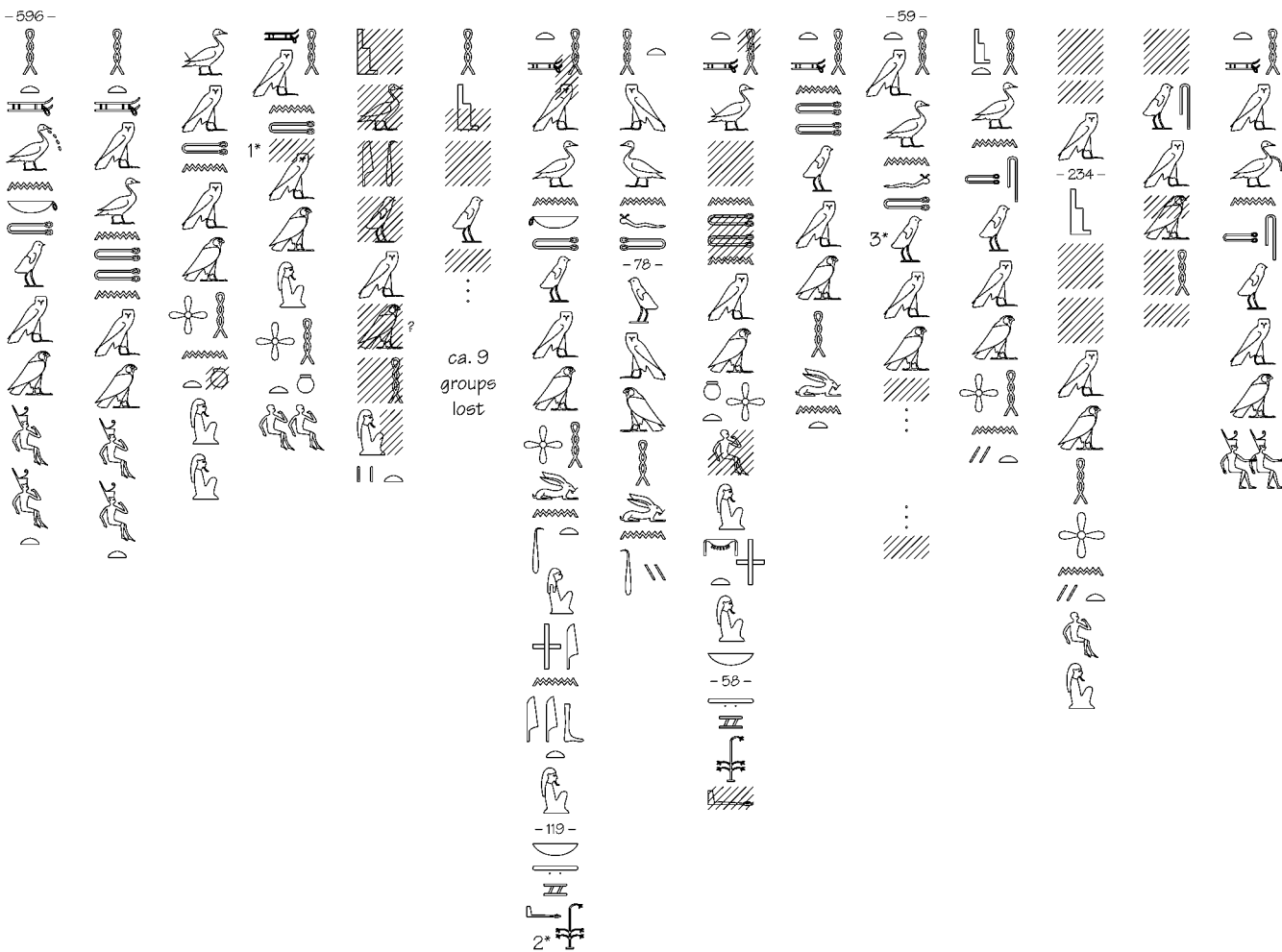



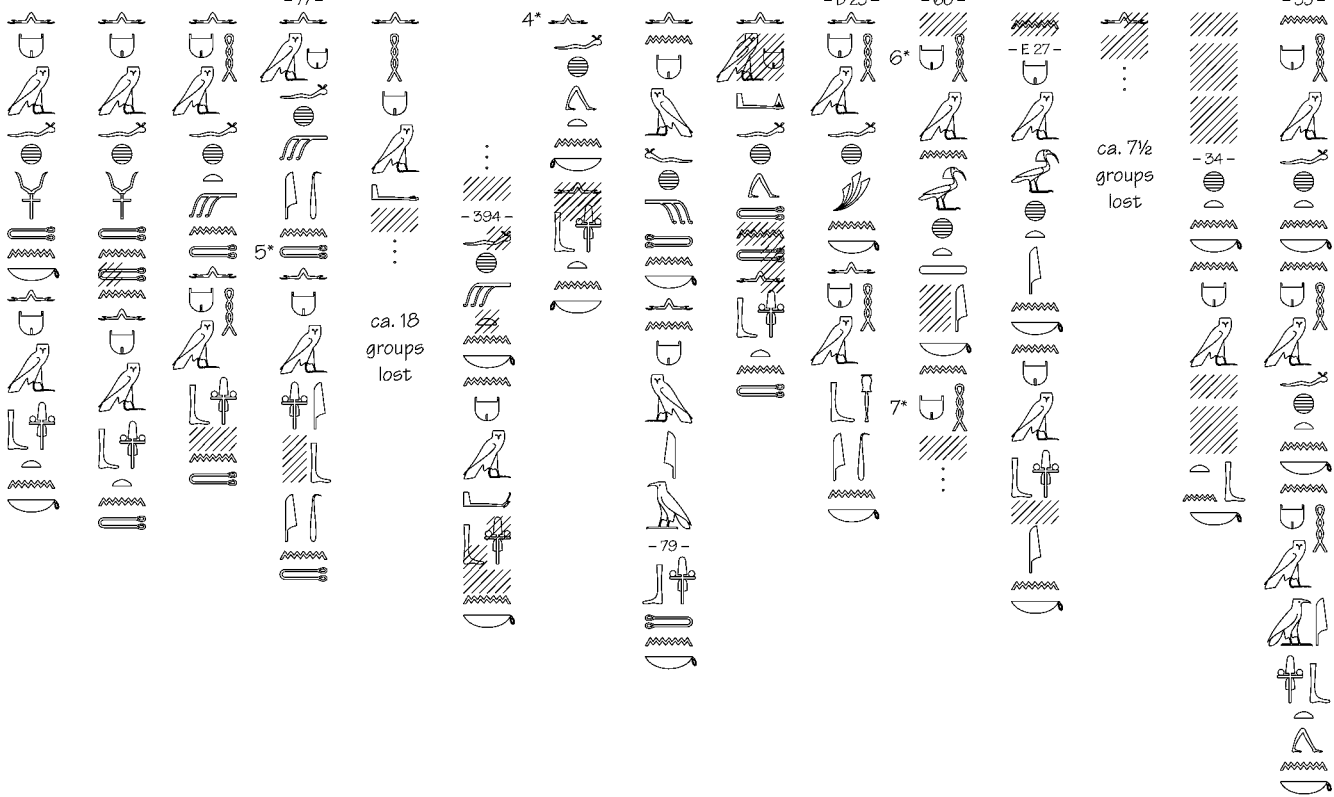



206b







































































	T4Be	T1C
206a		
206b		

- 1\* Just enough space for .
- 2\* Group with following.
- 3\* Publication shows  in front of : spurious?
- 4\* Group with preceding.
- 5\* Corrected from .
- 6\* Publication .
- 7\* Publication .

206c

B2Bo B3Bo B4Bo B6Bo B10C<sup>a</sup> B10C<sup>b</sup> BH3C BH5C BH20x L-A1 L3Li L1NY Sed1Sed Sq9C Sq1Ch

The grid displays hieroglyphs from various groups. The columns are labeled as follows: B2Bo, B3Bo, B4Bo, B6Bo, B10C<sup>a</sup>, B10C<sup>b</sup>, BH3C, BH5C, BH20x, L-A1, L3Li, L1NY, Sed1Sed, Sq9C, and Sq1Ch. The rows contain hieroglyphs, some with numerical labels: -300-, -228-, -59-, -61-, -E 28-, -35-, -34-, -597-, -78-, -120-, -80-, -62-, and -35-. Some groups are marked as 'ca. 11 groups lost'.

	T4Be	T1C
206c		
		
		
		
		
		
		
		
		
		
		
		
		
		
		
		
		
		
		
		
		
		
		
		
		
		
		
		
		
		
		
		
		

207a

B2Bo B3Bo B4Bo B6Bo B10Ca B10Cb BH3C BH5C BH20x L-A1 L3Li L1NY Sed1Sed Sq9C Sq1Ch

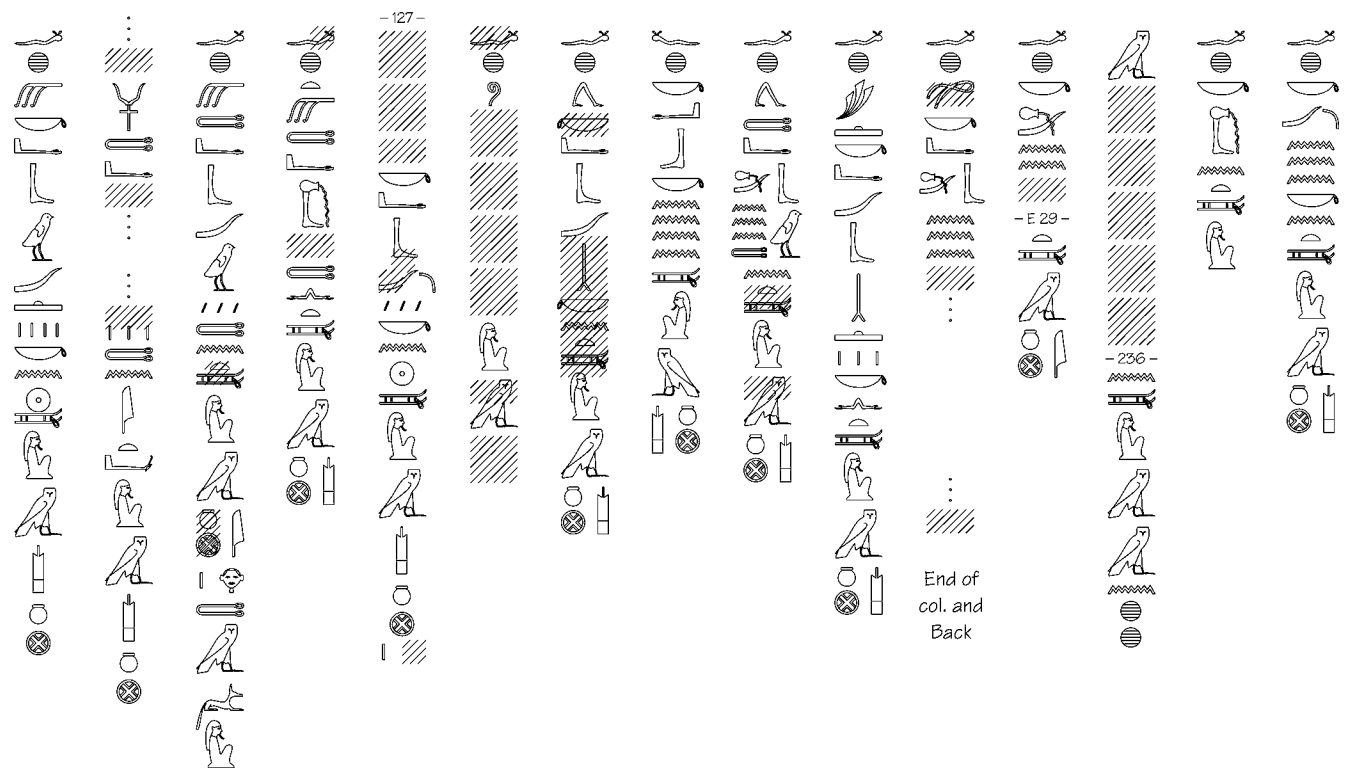

207b

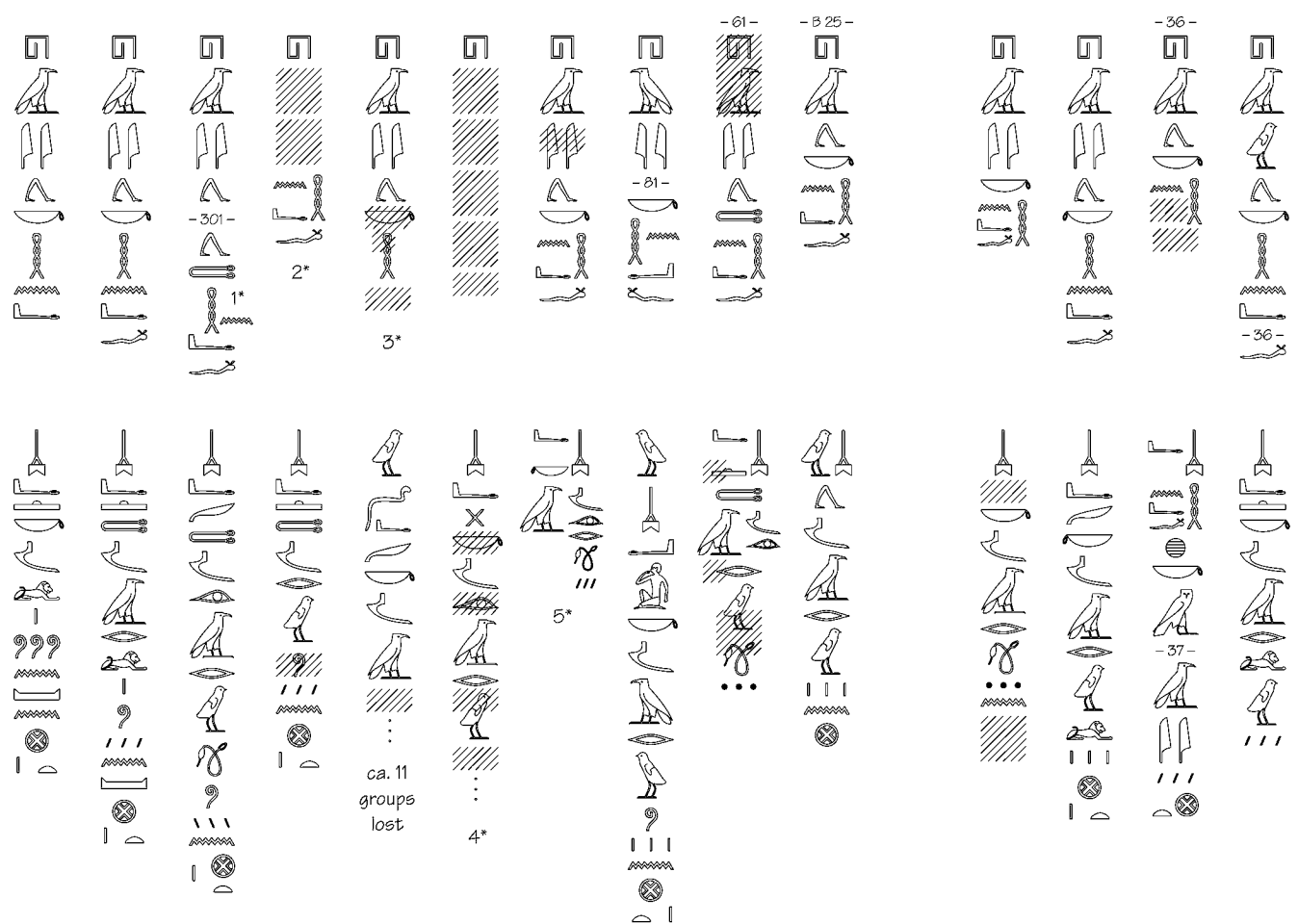

	T4Be	T1C
207a		
207b		

B6B0

1\* added secondarily.  
 2\* Text above follows before Pyr. 207b.  
 3\* Pyr. 207d end-208c intervenes.  
 4\* Ca. 13 groups lost to end of col. and Front.  
 5\* End of col. and section. CT 579 follows.



207d

	B2Bo	B3Bo	B4Bo	B6Bo	B10C <sup>a</sup>	BH5C	BH20x	L-A1	L1NY	Sq9C	Sq1Ch	T4Be	T1C

207e

208a

For notes see p. 242.

End of col. and Front

End of col. and Front

End of col. and Lid

3\*

- E 31 -

1\*

2\*

- 84 -

- 599 -

- 62 -

End of col. and Front

?

- 90 -

- 38 -

- 37 -

- 91 -

- 227 -

- 302 -

	B2Bo	B3Bo	B4Bo	B6Bo	B10C <sup>a</sup>	L-A1	Sq9C	Sq1Ch	T4Be	T1C
(208a)										
208b										
208c										

1\* Ca. 15 groups lost. After lacuna Pyr. 207b-c intervenes before Pyr. 209.



	B2Bo	B3Bo	B4Bo	B6Bo	B10C <sup>a</sup>	L-A1	Sq9C	Sq1Ch	T4Be	T1C
(208c)	-600- 				...					
209a										
209b										

	B2B <sub>0</sub>	B3B <sub>0</sub>	B4B <sub>0</sub>	B6B <sub>0</sub>	B10C <sup>a</sup>	L-A1	Sq1Ch	T1C
(209b)								
209c								
210a								

	B2Bo	B3Bo	B4Bo	B6Bo	B10C <sup>a</sup>	L-A1	Sq1Ch	T1C
(210a)				—				
210b								
210c								

	B2Bo	B3Bo	B4Bo	B6Bo	B10C <sup>a</sup>	L-A1	Sq1Ch	T1C
211a								
			-306-				-44-	-230-
211b								
		-232-					-45-	
						...		
						-B 29-		
						...		
211c					ca. 13 groups lost			

	B2B <sub>0</sub>	B3B <sub>0</sub>	B4B <sub>0</sub>	B6B <sub>0</sub>	B10C <sup>a</sup>	L-A1	Sq1Ch	T1C
211c								
	-603-				...	...	-46-	-230-
					ca. 10 groups lost	1*		
212a								
2* 2*					...			-307-
								-231-
212b								
2* 2*								

1\* End of col. and section. PT 213 follows in next section.  
 2\* For Pyr. 212-213 see also p. 77.

(212b)  
1\*

213a  
1\*

B2Bo	B3Bo	B4Bo	B6Bo	B10C <sup>a</sup>	Sq1Ch	T1C

(213a)  
1\*

213b  
1\*

B2Bo	B3Bo	B4Bo	B6Bo	B10C <sup>a</sup>	Sq1Ch	T1C

CT 1 follows    CT 1 follows    PT 213 follows    PT 368 follows    PT 25 follows

1\* For Pyr. 212-213 see also p. 77.  
 2\* Remainder of col. blank. CT 25 follows in col. 605.  
 3\* Probably not enough space for 𓆎.  
 4\* Ca. 13 groups lost. PT 213 follows.

	B2B0	L-MH1A	M2C	TT240
214a	- (566) - 	- E 1 - 	- (96) - 	- 62 - 
214b	 567			
214c	 - 568 - 			
	 - 569 - 			

	B2B0	L-MH1A	M2C	TT240
(214c)				
215a	 - 570 - 	 - E 3 - 	 - 99 - 	
215b	 - 571 - 	 - E 4 - 	 - 100 - 	

	B2B0	L-MH1A	M2C	TT240
(215b)	 - 572 - 			
215c	 - 573 - 			
216a	 - 573 - 	 E 5 		

End of col. and Front

CT 834 follows

1\* CTN copy unclear:

(PT 223)

<p>216b</p> <p>B2Bo L-MH1A</p>	<p>216c</p> <p>B2Bo L-MH1A</p>	<p>(216c)</p> <p>B2Bo L-MH1A</p>	<p>217b</p> <p>B2Bo L-MH1A</p>
--------------------------------	--------------------------------	----------------------------------	--------------------------------





























For notes see p. 253.

PT 224

<p>218c</p> <p>L-MH1A S5C</p>	<p>218f</p> <p>L-MH1A S5C</p>	<p>(219a)</p> <p>L-MH1A S5C</p>	<p>(219b)</p> <p>L-MH1A S5C</p>	<p>220a</p> <p>L-MH1A S5C</p>
-------------------------------	-------------------------------	---------------------------------	---------------------------------	-------------------------------

For notes see p. 253.













































	L-MH1A	S5C
(220b)	 	-51-  
	ca. 4½ groups lost	    
220c	    -E 8-     1*	-52-            CT 897 follows

Notes to p. 252:

- 1\* Group with following.
- 2\* Group with preceding.
- 3\* Remainder of col. blank. CT 751 follows in col. 576.
- 4\* Pyr. 220b follows.
- 5\* Pyr. 220c precedes.
- 6\* Remainder of col. lost. End of Front.
- 7\* Pyr. 219a precedes.

PT 226

L-MH1A	L1NY	Sq1C	Sq2C	T1Be	T3Be
-B 72-	-L1-	-27-	-18-	-258-	-34-
					
					
					
					
					
					
					
					
					
					
					

1\* Pyr. 219b follows.

	L-MH1A	L-Wsr1	L1NY	M7C	Sq1C	Sq2C	Sq1Sq	T1Be	T3Be
225a									
225b									
225c									

1\* Second seen only by Maspero.  
 "I see no trace of second n, but  
 there is a break here" (AdB).  
 2\* Group with following.  
 3\* CT 349 follows.

	L-MH1A	L-Wsr1	L1NY	M7C	Sq1C	Sq2C	Sq1Sq	T1Be
(225c)								
226a								
226b								
	PT 227 follows	PT 227 follows	PT 227 follows	PT 227 follows	PT 227 follows	PT 227 follows	PT 227 follows	PT 227 follows

1\* Group with preceding.  
 2\* Group with following.  
 3\* End of line. PT 300 follows in W 2.

256

PT 227

	L-MH1A	L1NY	M7C	Sq1C	Sq2C	Sq1Sq	T1Be
227a	(B 75)	(L 4)	(69)	(31)	(23)	(32)	(260)
227b	(B 76)	(L 5)	(71)	(33)	(25)	(34)	(261)

	L-MH1A	L1NY	M7C	Sq1C	Sq2C	Sq1Sq	T1Be
227c							
	PT 228 follows	PT 228 follows	PT 228 follows	PT 228 follows	PT 228 follows	PT 228 follows	PT 228 follows

1\* Probably nothing lost.

PT 228

	L-MH1A	L1NY	M7C	Sq1C	Sq2C	Sq1Sq	T1Be
228a	(B 76)	(L 6)	(73)	(34)	(26)	(34)	(261)

	L-MH1A	L1NY	M7C	Sq1C	Sq2C	Sq1Sq	T1Be
227c	(B 77)		(74)		(27)	(35)	

228b

L-MH1A	L1NY	M7C	Sq1C	Sq2C	Sq1Sq	T1Be

(228b)

L-MH1A	L1NY	M7C	Sq1C	Sq2C	Sq1Sq	T1Be
End of col. and Bottom	PT 229 follows	PT 229 follows	PT 229 follows	PT 229 follows	PT 229 follows	PT 229 follows

PT 229

229a

L1NY	M7C	Sq1C	Sq2C	Sq1Sq	T1Be

229b

L1NY	M7C	Sq1C	Sq2C	Sq1Sq	T1Be

(229b)

L1NY	M7C	Sq1C	Sq2C	Sq1Sq	T1Be
PT 230 follows	PT 230 follows	PT 230 follows	PT 230 follows	PT 230 follows	PT 230 follows





229c

L1NY	M7C	Sq1C	Sq2C	Sq1Sq	T1Be

1\* Seen only by Maspero.

	L-PWIA	L1NY	M7C	Sq1C	Sq2C	Sq1Sq	T1Be
230a	- (W 39) - ... - W 40 - ...	- (L 9) - ...	- (80) - ...	- 38 - ...	- (31) - ...	- (37) - ...	- 263 - ...
230b	...	- 10 - ...	- 83 - ...	- 34 - ...	...	...	...
230c	...	...	- 84 - ...	...	...	- 39 - ...	...

	L-PWIA	L1NY	M7C	Sq1C	Sq2C	Sq1Sq	T1Be
(230c)	...	...	...	...	...	...	- 264 - ...
230d	...	...	- 85 - ...	...	...	...	...

- 1\* There is a tiny trace like a second  to the left (erased?). Maspero saw  here.
- 2\* Dashed lines mark signs seen only by Passalacqua.
- 3\* Group with following.
- 4\* Corrected over .
- 5\* Group with preceding.
- 6\* Maspero saw only  here, but traces suggest this reading.

	L-PW1A	L1NY	M7C	Sq1C	Sq2C	Sq1Sq	T1Be
231a							
231b							
231c							

End of col. and Back

	L-PW1A	L1NY	Sq1C	Sq2C	Sq1Sq	T1Be
(231c)						
232a						
232b						

1\* 1/2 group blank.  
 2\* added secondarily.









PT 233

263

237a

L-PW1A	L1NY	Sq1C	Sq2C	Sq1Sq
-(W 55)-	-(L 23)-	-(59)-	-(55)-	-(50)-
...			ca. 5 groups lost	
...			...	
-W 56-			-56-	



241a

L-PW1A	L1NY	Sq1C	Sq2C	Sq1Sq
- (W 62) -	- (L 28) -	- 67 -	- (65) -	- (54) -
- W 63 -			- 66 -	- 55 -

(241a)

L-PW1A	L1NY	Sq1C	Sq2C	Sq1Sq
	- L 29 -	- 68 -		
			- 67 -	
PT 238 follows	PT 238 follows	PT 238 follows	PT 238 follows	PT 238 follows

PT 238

242a

L-PW1A	L1NY	Sq1C	Sq2C	Sq1Sq
- (W 63) -	- (L 29) -	- (68) -	- (67) -	- (55) -
- W 64 -		- 69 -		- 56 -

242b

L-PW1A	L1NY	Sq1C	Sq2C	Sq1Sq
	- L 30 -			3*
		2*		
		- 70 -		
242c	- W 65 -			
			- 66 -	
				- 57 -

1\* Group with following.

2\* Somewhat different from the usual form of :

2\* Group with preceding.

(PT 238)

	L-PW1A	L1NY	Sq1C	Sq2C	Sq1Sq
(242c)					
	PT 450 follows	PT 239 follows	PT 239 follows	PT 239 follows	PT 239 follows



PT 239

	L1NY	Sq1C	Sq2C	Sq1Sq
243a				

	L1NY	Sq1C	Sq2C	Sq1Sq
243b				
	PT 240 follows	PT 240 follows	PT 240 follows	PT 240 follows

	L1NY	Sq1C	Sq2C	Sq1Sq
244a	-L 32- 	-(75)- 	-(71)-  ca. 6 groups lost	-(58)- 
244b		 2* -74-	-72-  ca. 4 groups lost	
244c	 -L 34-	 -75-	-73-  ca. 7 groups lost	-60-  ca. 9 groups lost

	L1NY	Sq1C	Sq2C	Sq1Sq
245a			 -75- ca. 9 groups lost	
245b	 PT 241 follows	 CT 272 follows	 -76- 3*	 PT 241 follows

- 1\* Like  below but without foot line.
- 2\* Like  above but with foot line.
- 3\* Col. 76 lost. CT 397 follows in col. 77.

PT 241

PT 242

246a

L1NY	Sq1Sq
-(L 35)-	-(62)-
-L 36-	



257a L-Wsr1 -E1-  
 (257b) L-Wsr1  
 258a L-Wsr1  
 (258b) L-Wsr1  
 258c L-Wsr1 -E2-  
 258f L-Wsr1  
 259a L-Wsr1 1\*  
 259b L-Wsr1  
 End of line and Wall

257b

257c

258b

1\* N is

PT 249-250

PT 249

PT 250

266a T7C -E1-  
 (266a) T7C  
 (266b) T7C  
 267c T7C -(E1)-  
 PT 250 follows  
 End of col. and Front



276a  
L-JMH1  
-W 20-  
276b  
276c  
-W 21-  
277a

This column contains hieroglyphs from lines 276a to 277a. It starts with a vertical bar and a small circle, followed by various symbols including birds, lotus flowers, and geometric shapes. The column is labeled 'L-JMH1' at the top and includes line numbers 276a, 276b, 276c, and 277a. It also contains two width markers: '-W 20-' at the top and '-W 21-' in the middle.

277b  
L-JMH1  
277c  
278a

This column contains hieroglyphs from lines 277b to 278a. It features symbols such as birds, lotus flowers, and geometric shapes. The column is labeled 'L-JMH1' at the top and includes line numbers 277b, 277c, and 278a. It also contains two width markers: '-W 22-' in the middle and '-W 23-' at the bottom.

(278a)  
L-JMH1  
278b  
-W 23-  
278c

This column contains hieroglyphs from lines (278a) to 278c. It includes symbols like lotus flowers, birds, and geometric shapes. The column is labeled 'L-JMH1' at the top and includes line numbers (278a), 278b, and 278c. It also contains two width markers: '-W 23-' in the middle and '-W 24-' at the bottom.

279a  
L-JMH1  
279b  
279c  
279d

This column contains hieroglyphs from lines 279a to 279d. It features symbols such as birds, lotus flowers, and geometric shapes. The column is labeled 'L-JMH1' at the top and includes line numbers 279a, 279b, 279c, and 279d. It also contains two width markers: '-W 24-' in the middle and '-W 25-' at the bottom.

(279d)  
L-JMH1  
280a  
-W 25-  
280b  
408

This column contains hieroglyphs from lines (279d) to 280b. It includes symbols like birds, lotus flowers, and geometric shapes. The column is labeled 'L-JMH1' at the top and includes line numbers (279d), 280a, 280b, and 408. It also contains two width markers: '-W 25-' in the middle and '-W 26-' at the bottom.

280c  
L-JMH1  
281a  
282c  
1\*  
-W 26-  
-W 27-

This column contains hieroglyphs from lines 280c to 282c. It features symbols such as birds, lotus flowers, and geometric shapes. The column is labeled 'L-JMH1' at the top and includes line numbers 280c, 281a, and 282c. It also contains three width markers: '-W 26-' in the middle, '-W 27-' at the bottom, and '1\*' above the bottom section.

283a  
L-JMH1  
283b  
284a

This column contains hieroglyphs from lines 283a to 284a. It includes symbols like birds, lotus flowers, and geometric shapes. The column is labeled 'L-JMH1' at the top and includes line numbers 283a, 283b, and 284a. It also contains a width marker: '-W 27-' at the bottom.

284b  
L-JMH1  
284c  
285a

This column contains hieroglyphs from lines 284b to 285a. It features symbols such as birds, lotus flowers, and geometric shapes. The column is labeled 'L-JMH1' at the top and includes line numbers 284b, 284c, and 285a.

1\* Pyr. 281a end-282b omitted probably through homoioarcton (cf. this passage in Unis cols. 420-421).

285b	L-JMH1		286b	L-JMH1		286e	L-JMH1		287c	L-JMH1		(288b)	L-JMH1		289b	L-JMH1		290b	L-JMH1		(291a)	L-JMH1	
285c	L-JMH1		286c	L-JMH1		287a	L-JMH1		288a	L-JMH1		288c	L-JMH1		289c	L-JMH1		290c	L-JMH1		291b	L-JMH1	
285d	L-JMH1		286d	L-JMH1		287b	L-JMH1		288b	L-JMH1		289a	L-JMH1		290a	L-JMH1		290d	L-JMH1		291c	L-JMH1	
286a	L-JMH1		286e	L-JMH1		287c	L-JMH1		288c	L-JMH1		289b	L-JMH1		290b	L-JMH1		290e	L-JMH1		291d	L-JMH1	

1\* Group with following.  
2\* Group with preceding.

(PT 254)

291d L-JMH1

292a L-JMH1

292b L-JMH1

(292b) L-JMH1

292d L-JMH1

293a L-JMH1

293c L-JMH1

294 L-JMH1

PT 255 follows

PT 255

295b L-JMH1

(295c) L-JMH1

296a L-JMH1

296b L-JMH1

(297a) L-JMH1

(297b) L-JMH1

(297c) L-JMH1

298a L-JMH1

295d L-JMH1

297a L-JMH1

297b L-JMH1

297c L-JMH1

297d L-JMH1

297e L-JMH1

- W 38 -

- W 39 -

- W 40 -

- W 41 -

274

(PT 255)

298b L-JMH1

298c L-JMH1

299a L-JMH1

299b L-JMH1

(299b) L-JMH1

300a L-JMH1

300b L-JMH1

300c L-JMH1

PT 256 follows

1\* Group with following.  
 2\* Group with preceding.  
 3\*  of col. top.

PT 256

301a L-JMH1

301b L-JMH1

301c L-JMH1

302a L-JMH1

302c L-JMH1

(302d) L-JMH1

303a L-JMH1

303b L-JMH1

(303c) L-JMH1

303d L-JMH1

PT 257 follows

# PT 257

	L-JMH1	L-JMH1	L-JMH1	L-JMH1	L-JMH1	L-JMH1	L-JMH1
304a	(-W 46-)	304c	304e	(305a)	(306a)	306c	307b
304b		304d	305a	305b	306b	306d	307c
				306a			
							PT 258 follows

# PT 258

	L-JMH1	L-JMH1	L-JMH1	L-JMH1	L-JMH1	L-JMH1	L-JMH1
308a	(-W 50-)	308b	308c	(308d)	(308e)	308f	309a
				308e			

276

(PT 258)

<p>309c</p> <p>L-JMH1</p> <p>-W53-</p> <p>309d</p>	<p>309e</p> <p>L-JMH1</p>	<p>310a</p> <p>L-JMH1</p> <p>310b</p> <p>-W54-</p>	<p>310c</p> <p>L-JMH1</p> <p>310d</p>	<p>310e</p> <p>L-JMH1</p> <p>311a</p>	<p>(311a)</p> <p>L-JMH1</p> <p>311b</p> <p>-W55-</p>	<p>311c</p> <p>L-JMH1</p>	<p>311d</p> <p>L-JMH1</p> <p>PT 260 follows</p>
--	---------------------------	--	---------------------------------------	---------------------------------------	--	---------------------------	---

PT 260

<p>316a</p> <p>L-JMH1</p> <p>-W55-</p> <p>-W56-</p>	<p>316b</p> <p>L-JMH1</p>	<p>316c</p> <p>L-JMH1</p> <p>-W57-</p>	<p>316d</p> <p>L-JMH1</p>	<p>317a</p> <p>L-JMH1</p> <p>1*</p>	<p>317b</p> <p>L-JMH1</p> <p>-W58-</p>	<p>317c</p> <p>L-JMH1</p>	<p>318a</p> <p>L-JMH1</p>
---	---------------------------	--	---------------------------	-------------------------------------	--	---------------------------	---------------------------

1\* Group with following.  
2\* Group with preceding.



318b

L-JMH1

319b

L-JMH1

-W 60-

320b

L-JMH1

321c

L-JMH1

-S1-

322b

L-JMH1

-S2-

323c

L-JMH1

-S3-

318c

319c

320a

321a

322a

323a

323d

PT 261 follows

319a

320a

321b

322a

323b

1\*

2\*

3\*

-W 59-

1\* ♀

2\*

-W 61-

1\* Group with following.  
 2\* Group with preceding.  
 3\* End of West wall.



L-JMH1

330b

330c

331a

-s 11-

-s 12-

L-JMH1

331b

331c

332a

-s 12-

L-JMH1

332b

332c

333a

-s 13-

333b

L-JMH1

333c

334a

334b

-s 14-

L-JMH1

334c

335a

335b

-s 15-

L-JMH1

335b

335c

336a

-s 16-

L-JMH1

336a

336b

PT 263 follows

337a L-JMH1 - (516) -  
 337b L-JMH1 - 517 -  
 337c L-JMH1 - 518 -  
 337d L-JMH1 - 519 -  
 338a L-JMH1 - 520 -  
 338b L-JMH1 - 521 -  
 338c L-JMH1 - 522 -  
 339a L-JMH1  
 339b L-JMH1  
 339c L-JMH1  
 340a L-JMH1  
 340b L-JMH1  
 340c L-JMH1  
 340d L-JMH1  
 341a L-JMH1  
 341b L-JMH1  
 341c L-JMH1  
 PT 267 follows

Note to p. 281:  
 1\* Group with first sign of N (𓂏).

1\* Group with first sign of N (𓂏).



372d L-JMH1 - E 33 -

(372e) L-JMH1

373c L-JMH1

374a L-JMH1 - E 35 -

374b L-JMH1

374c L-JMH1 - E 36 -

(374c) L-JMH1

375b L-JMH1

372e

373a

373b

375a

ca. 8½ groups lost

PT 269 follows

PT 269

376a L-JMH1 L-SS1A - (E 37) - -1-

(376a) L-JMH1 L-SS1A

376b L-JMH1 L-SS1A

(376b) L-JMH1 L-SS1A

376c L-JMH1 L-SS1A -2-

ca. 5 groups lost

ca. 9 groups lost

L-JMH1 L-SS1A

(376c)

377a

ca. 6 groups lost

ca. 8 groups lost

377b

L-JMH1 L-SS1A

377c

378a

378b

L-JMH1

379a

379b

ca. 10 groups lost

379c

ca. 10 1/2 groups lost

L-JMH1

380a

380b

ca. 13 groups lost

L-JMH1

381a

381b

381c

381d

L-JMH1

382a

382b

PT 270 follows

1\* Ca. 8 groups lost, then traces of N, then remainder lost.

383a

L- JMH1<sup>a</sup> L- JMH1<sup>b</sup>

-(E 45)- -S 27-

1\*

ca. 8½ groups lost

383b

383c

ca. 11½ groups lost

(383c)

384a

384b

385a

ca. 9½ groups lost

3\*

sic

385c

L- JMH1<sup>a</sup> L- JMH1<sup>b</sup>

-S 29-

-E 48-

386a

386b

-E 49-

(386b)

L- JMH1<sup>a</sup> L- JMH1<sup>b</sup>

387a

387b

ca. 12½ groups lost



387c

L- JMH1<sup>a</sup> L- JMH1<sup>b</sup>

-E 50-

PT 271 follows

End of col. and South wall

- 1\*  of col. top.
- 2\* Group with following. Original , centered in col., erased between these two signs.
- 3\* Group with preceding.



# PT 271

285

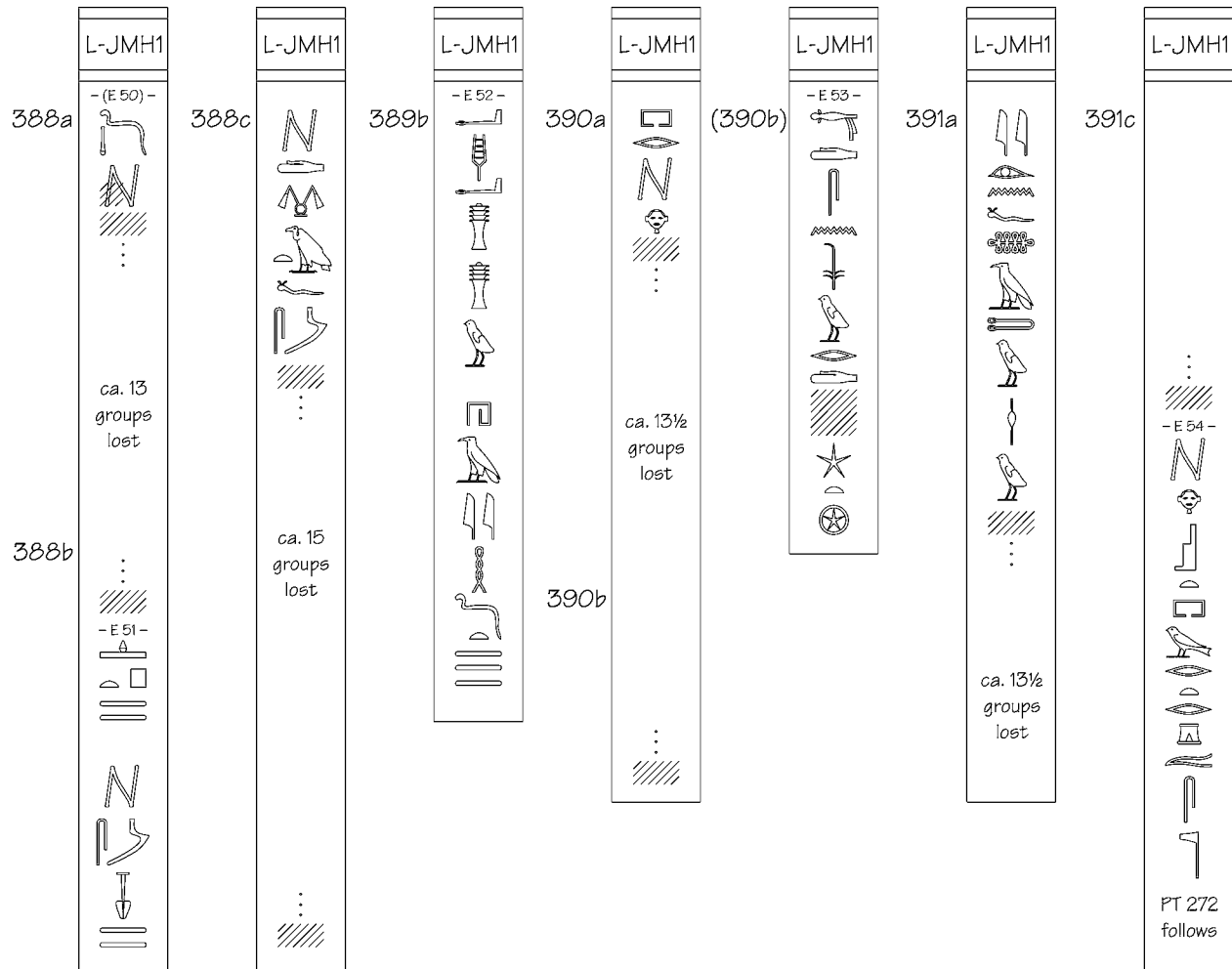

# PT 272

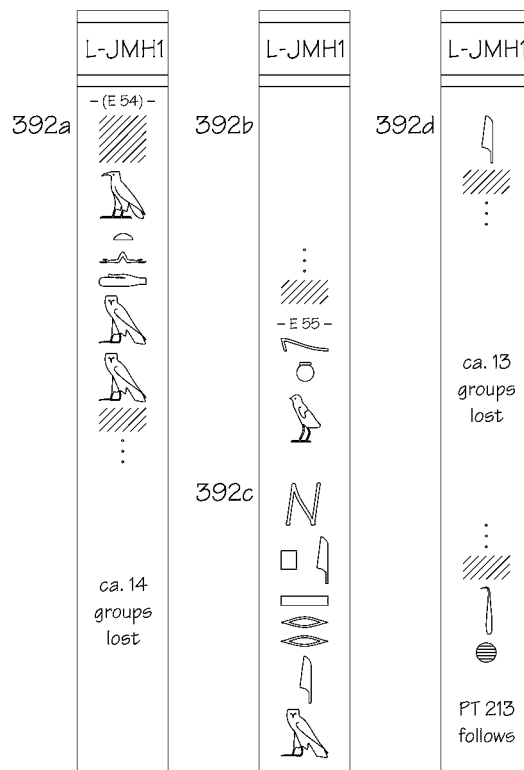

PT 300

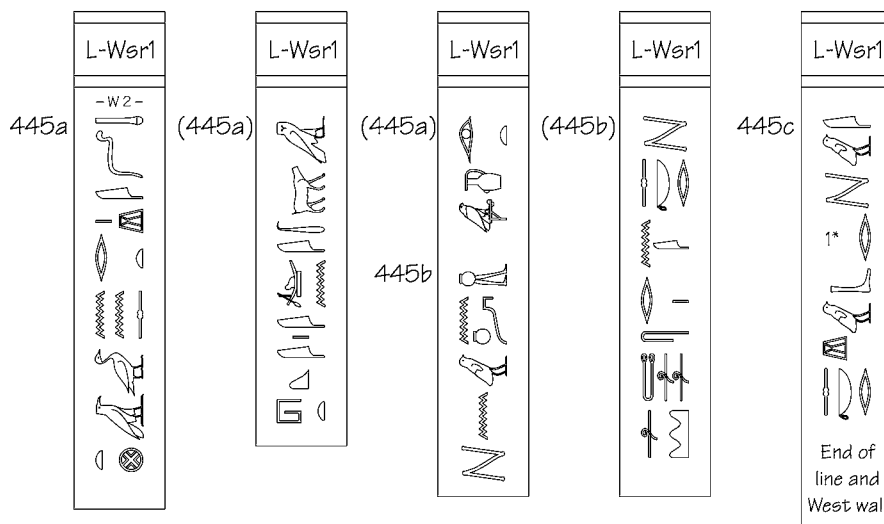

PT 304

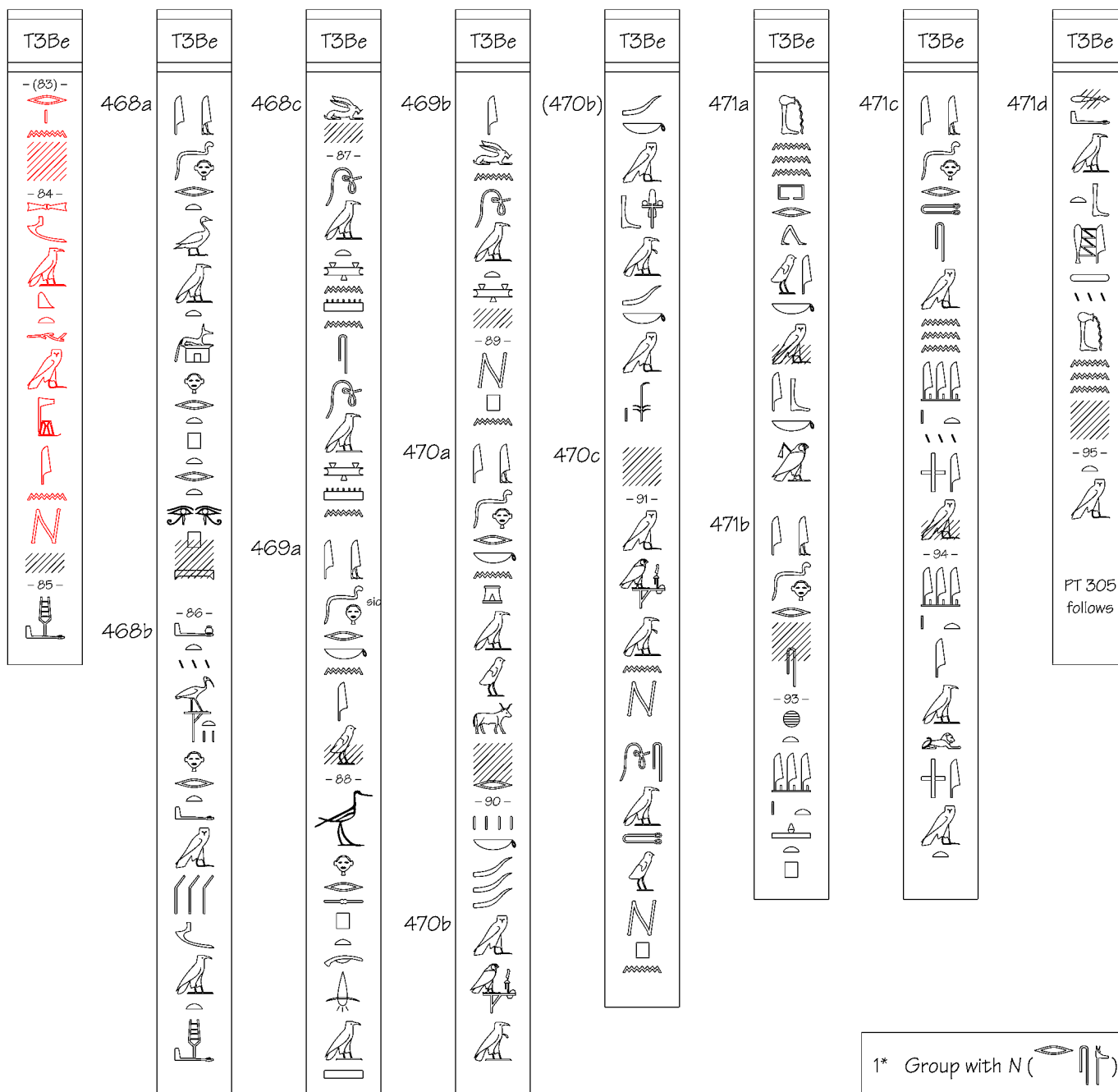

# PT 305

472a	T3Be -(95)- 	472b	T3Be 	472c	T3Be -97- 	(472d)	T3Be -98- 	473a	T3Be 	474b	T3Be 	(474b)	T3Be 	475a	T3Be 
				472d				474a		474c			475b		
														CT 830 follows	

# PT 306

476a	L-JMH1 R1X -N1- -11- 	(476a)	L-JMH1 R1X 	476b	L-JMH1 	477a	L-JMH1 	477c	L-JMH1 	478a	L-JMH1 	478b	L-JMH1 
						477b						479a	
<p>1* Corrected from </p> <p>2* Publication </p> <p>3*  of col. top.</p> <p>4* End of col. and Head. Spell may have continued on Foot (only traces).</p>													

(479a) L-JMH1

(479b) L-JMH1

480b L-JMH1

(480c) L-JMH1

481a L-JMH1

481b L-JMH1

481c L-JMH1

(481d) L-JMH1

479b

480a

480c

480d

481d

PT 307 follows

PT 307

482a L-JMH1

(482b) L-JMH1

483a L-JMH1

483b L-JMH1

(483c) L-JMH1

(484b) L-JMH1

(484c) L-JMH1

485a L-JMH1

482b

482c

483c

484a

484c

484d

(PT 307)

485b (485b) 485c (485c) 486a (486b) 486c 486d

L-JMH1 L-JMH1 L-JMH1 L-JMH1 L-JMH1 L-JMH1 L-JMH1 L-JMH1

PT 308 follows

PT 308

487a (487b) (487c) (488a) 489a 489b 489c 489d

L-JMH1 L-JMH1 L-JMH1 L-JMH1 L-JMH1 L-JMH1 L-JMH1 L-JMH1

PT 309 follows

1\* Group with following.  
2\* Group with preceding.

290

PT 309

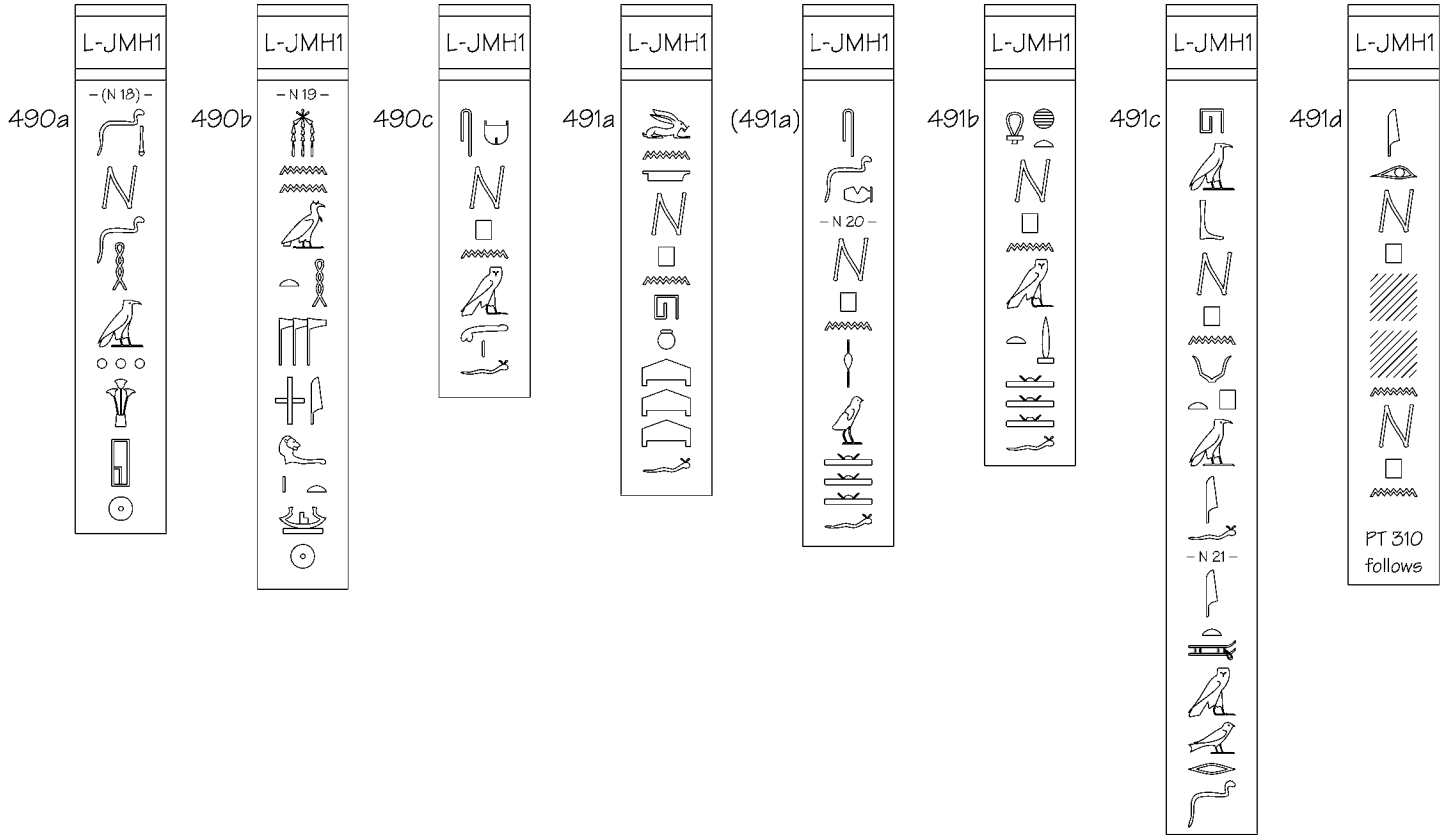

PT 310

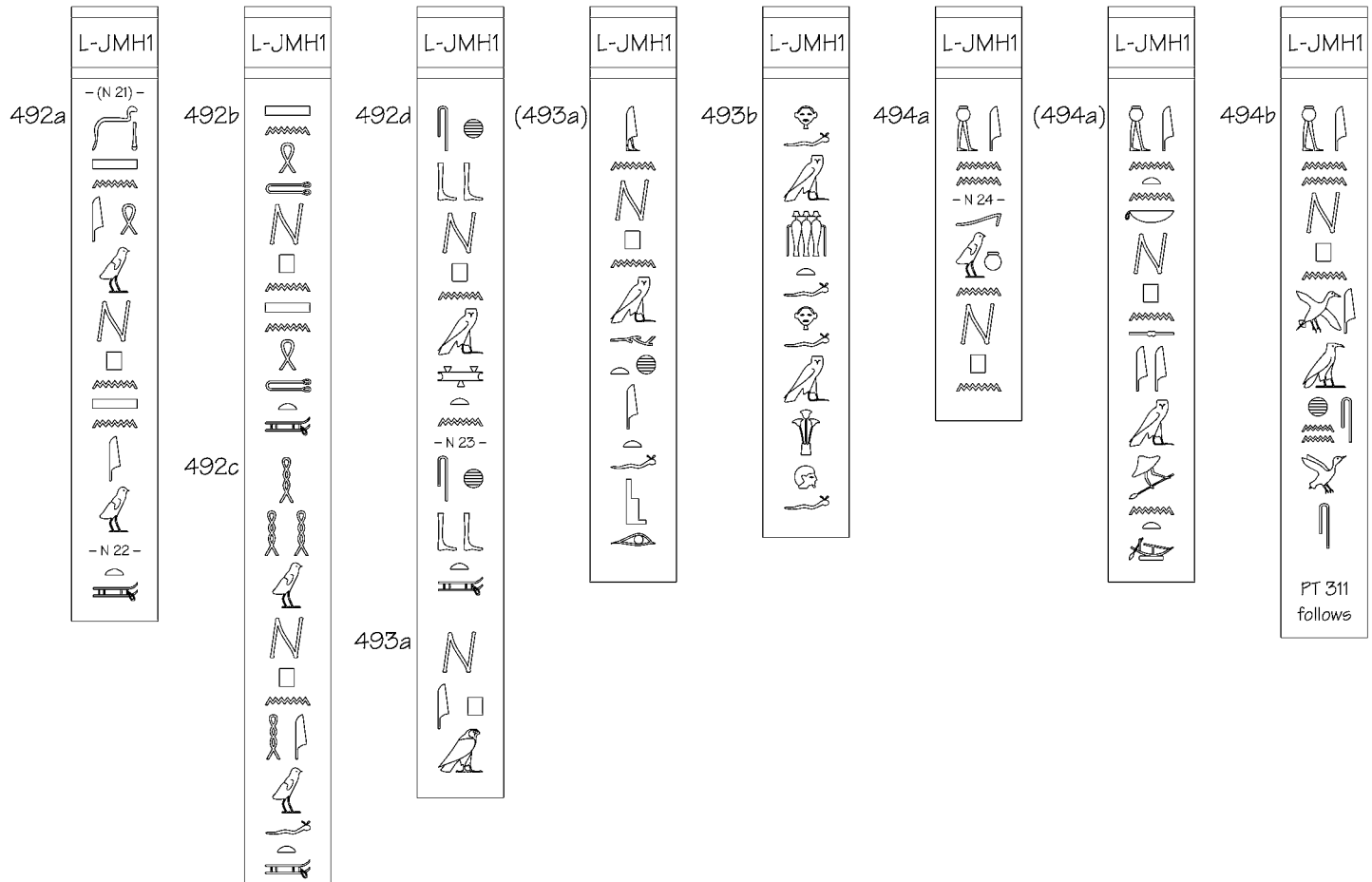

# PT 311

495a	L-JMH1 - N 25 - 1*	495c	L-JMH1	496b	L-JMH1	497a	L-JMH1 - N 27 -	497c	L-JMH1 - N 28 -	498b	L-JMH1	(499a)	L-JMH1	500b	L-JMH1
495b		496a	L-JMH1 - N 26 -			497b		498a		499a		499b		500c	
												499c			
												500a			
														500d	

PT 312 follows

# PT 312

501

L-JMH1
- (N 30) -
2*

1\* of col. top.  
 2\* End of col. and North wall.

292

PT 313

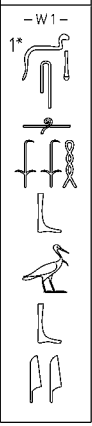
502a <sup>L-JMH1</sup> <sup>-w1-</sup> 1\* 

(502a) <sup>L-JMH1</sup> 

502b <sup>L-JMH1</sup> 

(502b) <sup>L-JMH1</sup> 

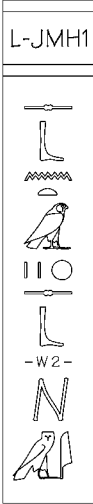
503a <sup>L-JMH1</sup> 

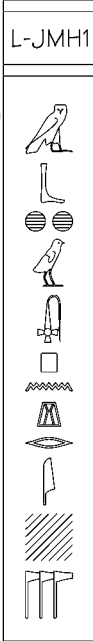
(503a) <sup>L-JMH1</sup> 

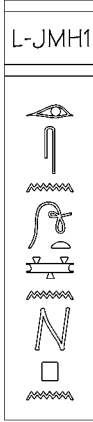
503b <sup>L-JMH1</sup> 

(503b) <sup>L-JMH1</sup>   
PT 314 follows

PT 314

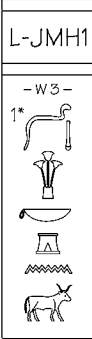
504a <sup>L-JMH1</sup> <sup>-w3-</sup> 1\* 

(504a) <sup>L-JMH1</sup> 

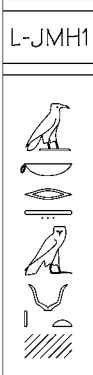
(504a) <sup>L-JMH1</sup> 

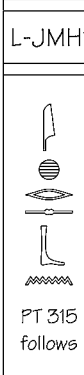
504b <sup>L-JMH1</sup>   
PT 315 follows

PT 315

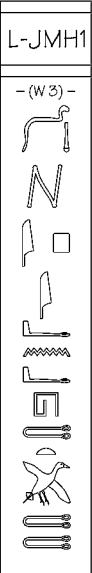
505a <sup>L-JMH1</sup> <sup>-(w3)-</sup> 

505b <sup>L-JMH1</sup>   
<sup>-w4-</sup>

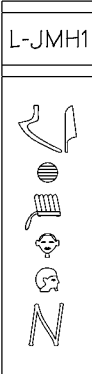
(505b) <sup>L-JMH1</sup> 

505c <sup>L-JMH1</sup> 

(505c) <sup>L-JMH1</sup>   
PT 316 follows

1\*  of col. top.

2\* Group with first sign of N ().



# PT 316

L-JMH1	L-JMH1	L-JMH1	L-JMH1	L-JMH1
-W4-	-W5-			
506a	(506a)	506b	(506b)	506c
				PT 317 follows

# PT 317

L-JMH1	L-JMH1	L-JMH1	L-JMH1	L-JMH1	L-JMH1	L-JMH1	L-JMH1
-W5-							
507a	(507b)	508a	508b	509b	510a	510b	(510c)
	507c		-W6-	1*	-W9-		510d
507b	-W7-			509c		510c	
				sic			PT 318 follows

1\* Pyr. 509a omitted probably through homoioteleuton with Pyr. 508b.

294

PT 318

511a

L-JMH1

-W10-

(511a)

L-JMH1

511b

511c

L-JMH1

(511c)

L-JMH1

512a

L-JMH1

512b

L-JMH1

512c

L-JMH1

-W13-

512d

L-JMH1

PT 319 follows

PT 319

513a

L-JMH1 Sq1Sq

-W13- -71-

513b

L-JMH1 Sq1Sq

-72- -W14-

513c

L-JMH1 Sq1Sq

2\*

513d

L-JMH1

-W14-

1\* of Pyr. 512a beg. omitted possibly through homoi-arcton (N begins with ).

2\* End of col. N follows in col. 73, then CT 335 in col. 74.

(PT 319)

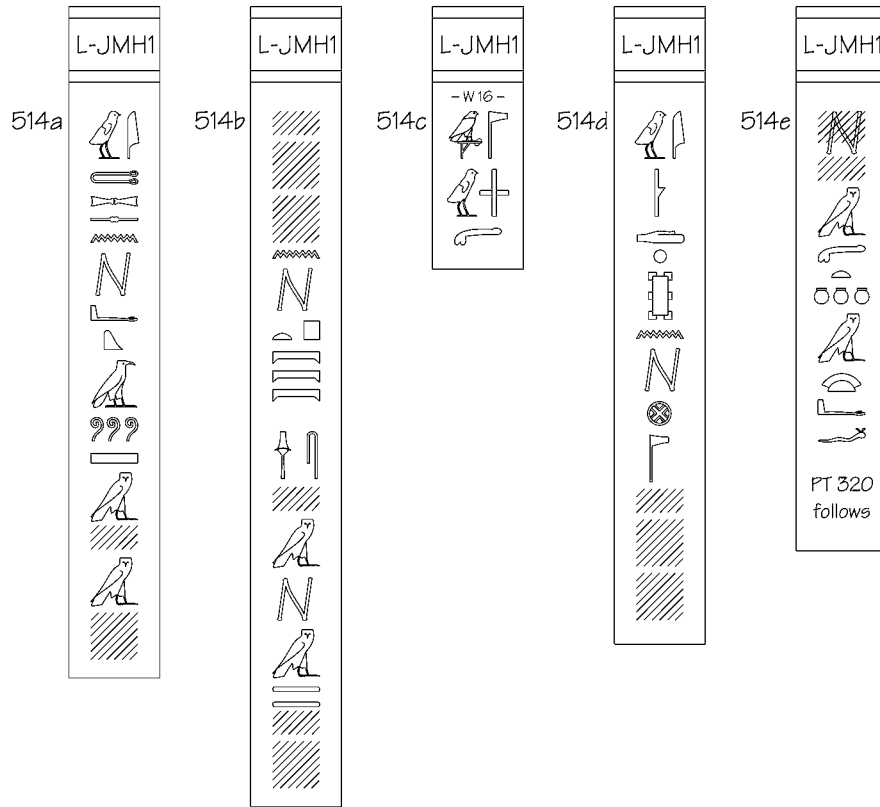

PT 320

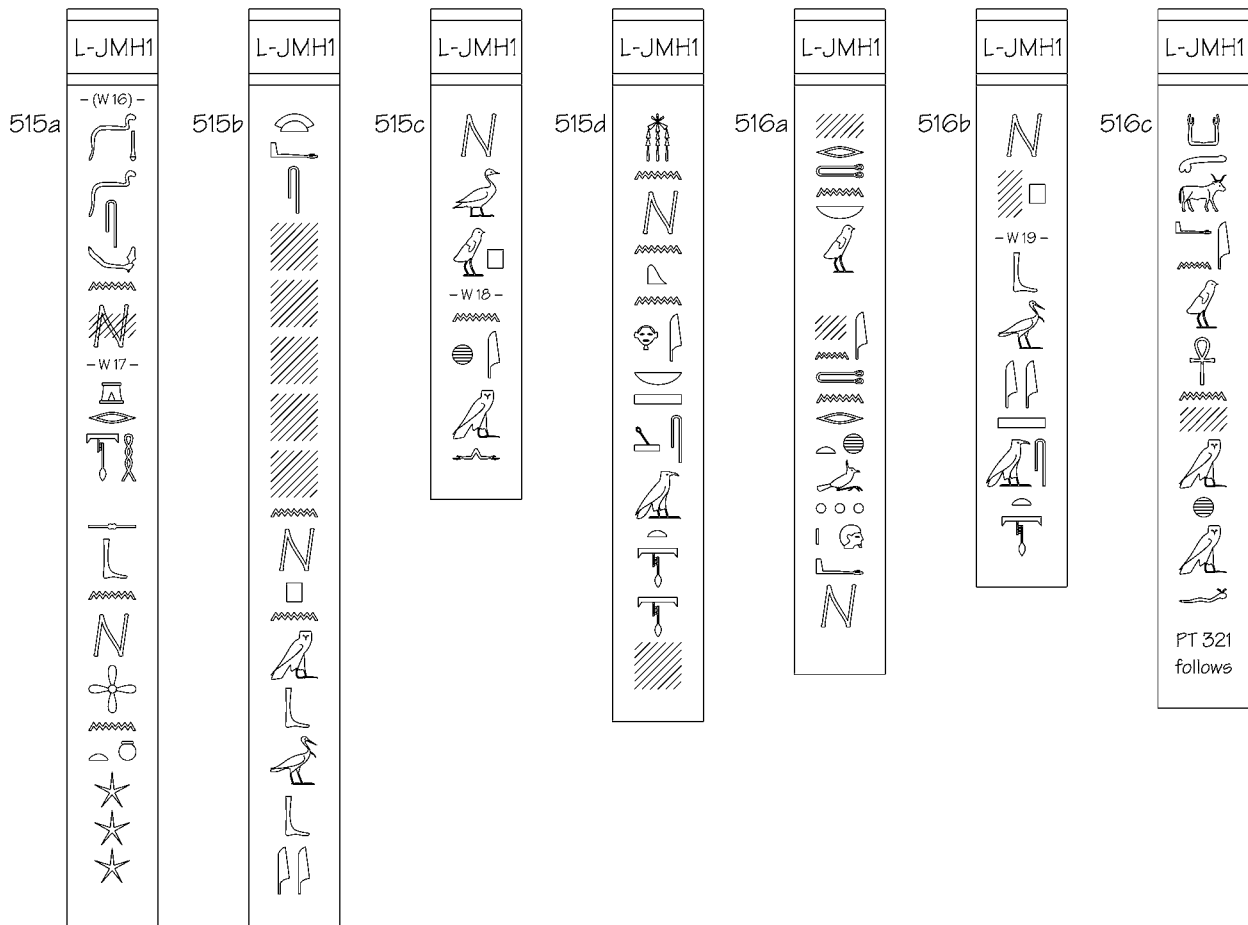

# PT 321

517a	L-JMH1 -(W 19)- 	(517a)	L-JMH1 	(517a)	L-JMH1 	518a	L-JMH1 	(518a)	L-JMH1  PT 254 follows
------	------------------------	--------	------------	--------	------------	------	------------	--------	------------------------------

# PT 332

541a	B9C -(373)- 1*	B10C -(375)- 1* 	541c	B9C 	B10C 	541d	B9C 	B10C 	541e	B9C 	B10C 
------	----------------------	---------------------------	------	---------	----------	------	---------	----------	------	---------	----------

ca. 9½ groups lost

ca. 15½ groups lost

CT 518 follows

CT 518 follows

541b

-(374)-

sic

1\*

2\*

1\* PT 372 precedes.  
2\* Dashed lines mark signs seen only by Lacau.

	B9C	B10C	L-MH1A	L3Li	Sq3C	Sq4C <sup>a</sup>	Sq4C <sup>b</sup>	Sq13C	T1C
575a	- (297) - 	- (260) - 	- (W 30) - 	- (31) - 	- 184 - 	- (150) - 	- (169) - 	- 27 - 	- (150) - 
575b	- 298 - 	 ca. 7½ groups lost				- 151 - 		- 28 - 	- 151 - 

1\* Group with final  $\int$  of N. N (mntw-htp) is preceded by , either dittography or from an original mn pn.

2\* Publication shows a  $\triangle$  between  and : spurious?

3\* Publication .

	B9C	B10C	L-MH1A	L3Li	Sq3C	Sq4C <sup>a</sup>	Sq4C <sup>b</sup>	Sq13C	T1C
575c									
576a									
	ca. 18 groups lost								
576b									
		ca. 8 1/2 groups lost							

1\* End of col. CT 301 follows in col. W 32.  
 2\* PT 221 (Pyr. 197c) follows.



	Sq3C	Sq4C <sup>a</sup>	T1C
577a			
578a			
578b			

	Sq3C	Sq4C <sup>a</sup>	T1C
578c			
578d			
579a			

	Sq3C	T1C
(579a)		
579b		
580a		

	Sq3C	T1C
(580a)		
580b		

1\* Group with following.  
 2\* Group with preceding.  
 3\* End of col. and upper register of Foot. CT 21 follows in lower register (col. 160).





	B9C	B10C	Sq4C	Sq13C
(590b)				- (31) - 
590c			- 175 - 	 ca. 5 groups lost
591a				

	B9C	B10C	Sq4C	Sq13C
(591a)				
591b			 - 176 - ca. 4 groups lost	 - 33 -
591c				
			 ca. 14 groups lost	 - 263 - 2*

	B9C	B10C	Sq4C	Sq13C
(591c)				
592a				- 34 - ca. 8 1/2 groups lost
592b			- 177 - 	

1\* Dashed lines mark signs seen only by Lacau.  
 2\* Group with following.  
 3\* Group with preceding.  
 4\* Corrected over .  
 5\* Or .



	B9C	B10C	B16C	S10C	Sq4C	Sq13C
609a	-(302)- 	-(263)- 	-(54a)- 	-(281)- 	-(177)- 	-(35)- 
	ca. 15 groups lost					
609b						
609c	ca. 6 groups lost					

1\* N is 2 groups.

2\* Probably including Pyr. 609b-c.

	B9C	B10C	B16C	S10C	Sq4C	Sq13C
(609c)						
610a						
610b						

ca. 13½ groups lost

ca. 12½ groups lost 2\*

	B9C	B10C	B16C	S10C	Sq4C	Sq13C
610c						
610d						
611a						

	B9C	B10C	B16C	S10C	Sq4C	Sq13C
(611a)						
611b						
612a						

-304-

-181-

-39-

-284-

ca. 15 1/2 groups lost

ca. 7 1/2 groups lost

5 groups lost

-182-

-40-

-285-

-265-

	B9C	B10C	B16C	S10C	Sq4C	Sq13C
(612a)						
612b						
613a						

	B9C	B10C	B16C	S10C	Sq4C	Sq13C
(613a)						
613b						
613c						

ca. 16 1/2 groups lost

	B9C	B10C	B16C	B17C	S10C	S14C	Sq4C	Sq13C
614a								
614b								
614c								

Notes to p. 306:  
 1\* Pyr. 590a.  
 2\* PT 371 (Pyr. 648d-650a) follows before Pyr. 613c.

1\* Lacuna of ca. 46 cols. precedes; ca. 14½ groups lost at beginning of this col.  
 2\* One col. of original MS apparently omitted.  
 3\* See B17C 2-7 (p. 450).

	B9C	B10C	B16C	B17C	S10C	S14C	Sq4C	Sq13C
614d								
615a								

1\* Apparently not or ; small gap follows.  
 2\* See B17C 2-7 (p. 450).



	B9C	B10C	B16C	B17C	S10C	S14C	Sq4C	Sq13C
615b			 -49a-	 1*	 -180-	 ca. 9½ groups lost		 ca. 4½ groups lost
615c	 ca. 15 groups lost	 ca. 9½ groups lost						 -48-
615d				 -290-				

1\* See B17C 2-7 (p. 450).

	B9C	B10C	B16C	S10C	S14C	Sq4C	Sq13C
616a	...	-267- 	-47b- 		... 		
	-308- 					-189- 	
					<		

	B9C	B10C	B16C	S10C	S14C	Sq4C	Sq13C
617a			 -46b-				
617b					 -183-	 -52-	 -192-
617c		 ca. 6 groups lost			 ca. 18 groups lost	 ca. 12 groups lost	 ca. 9 1/2 groups lost

	B9C	B10C	B16C	S10C	S14C	Sq4C	Sq13C
618a			 -45c-		 -184-	 -193-	 -53-
618b					 ca. 18 groups lost		 ca. 8 1/2 groups lost
619a					 -185-	 -194-	 -54-

1\* Ca. 9 1/2 groups lost. PT 368 follows.



621b

B9C	B10C	B16C	S10C	S14C	Sq4C
...					

	B6C	B9C	B10C	Sq4C
(622b)				
622c				
622d				

	B6C	B9C	B10C	Sq4C
623a				
623b				
623c				

	B6C	B9C	B10C	Sq4C
624a				
624b				
624c				

1\* Space for left blank.  
 2\* Or

(PT 365)

	B6C	B9C	B10C	Sq4C
625a				
625b				

-276-  
-218-  
ca. 16 groups lost

	B6C	B9C	B10C	Sq4C
(625b)				
625c				

-219-  
-322-  
ca. 10 groups lost

	B6C	B9C	B10C	Sq4C
622d				

1\* PT 373 follows  
PT 373 follows  
PT 373 follows

1\* Remainder of col. blank.  
End of Back.  
2\* Pyr. 628b follows.  
3\* Pyr. 632a follows.  
4\* Ca. 11 groups lost to end of col. and Back.

PT 366

	B9C	B10C <sup>a</sup>	B10C <sup>b</sup>	Sq3C	Sq13C
626a					

- (349) -  
- 294 -  
- (438) -  
- (118) -  
- 14 -  
ca. 6 groups lost

	B9C	B10C <sup>a</sup>	B10C <sup>b</sup>	Sq3C	Sq13C
(626a)					

4\*

	B9C	B10C <sup>b</sup>	Sq3C	Sq13C
626b	<p>...</p> <p>-350-</p>	<p>sic</p>		<p>-15-</p>
626c		<p>-120-</p>		
626d		<p>...</p> <p>ca. 6 groups lost</p>		

	B9C	B10C <sup>b</sup>	Sq3C	Sq13C
627a			<p>-121-</p>	<p>-16-</p>
627b	<p>...</p> <p>ca. 8 groups lost</p> <p>-351-</p>			<p>ca. 5½ groups lost</p>

	B9C	B10C <sup>b</sup>	Sq3C	Sq13C
628a			<p>-122-</p>	<p>-17-</p>
628b		<p>-440-</p>	<p>1*</p> <p>-123-</p>	<p>-18-</p>

1\* For Pyr. 628b-629c see also p. 455.





	B9C	B10C <sup>b</sup>	Sq3C	Sq13C
630a				
630b				

	B9C	B10C <sup>b</sup>	Sq3C	Sq13C
630c				
631a				

	B9C	B10C <sup>b</sup>	Sq3C	Sq13C	Sq55a
631b					
632a					

1\* Dashed lines mark signs seen only by Lacau.

	B9C	B10C <sup>b</sup>	Sq3C	Sq13C	Sq55a
632b					
632c					

	B9C	B10C <sup>b</sup>	Sq3C	Sq13C
632d				
633a				

	B9C	B10C <sup>b</sup>	Sq3C	Sq13C
633b				
	PT 367 follows	PT 367 follows	CT 856 follows	

1\* Ca. 5 groups lost. PT 356 follows.

	B9C	B10C	L-MH1A <sup>a</sup>	L-MH1A <sup>b</sup>	L3Li	Sq3C	Sq4C	Sq5C	Sq6C	Sq1Cop	T1C
634a	-(354)-  ca. 6 groups lost	-(442)- 	-(W 26)-  -W 27-	-(L 89)-  ca. 7 groups lost	-(26)- 	-(150)- 	-(111)-  ca. 6½ groups lost	-(49)-  -50-	-(137)- 	-(45)-  -46-	-(146)-  -147-
634b				 3*	 -151-	 ca. 4½ groups lost		 -138-		 4*	
634c											

1\* Group with final of N.  
 2\* is also final sign of N.  
 3\* Publication .  
 4\* Remainder lost. 4 more cols., with traces only, follow to end of section.

	B9C	B10C	L-MH1A <sup>a</sup>	L-MH1A <sup>b</sup>	L3Li	Sq3C	Sq4C	Sq5C	Sq6C	T1C
(634c)				 End of col. and Lid	 -28-		 ca. 6 1/2 groups lost			
634d	 ca. 5 1/2 groups lost		 -W 28- 2*		 3* ?		 -113-			 -148-
		 -443-			 -29-		 -51-		 -139-	
635a					 -152-					

1\* added secondarily.  
 2\* under of col. top.  
 3\* Publication .

	B9C	B10C	L-MH1A <sup>a</sup>	L3Li	Sq3C	Sq4C	Sq5C	Sq6C	T1C
(635a)		 ca. 5 groups lost	 -W 29-				 ca. 6½ groups lost		 -149-
635b			 -30-	 1*	 -14-			 -140-	
635c			 3* 2*	 sic -31-			 -52-		
635d									
	PT 368 follows	PT 368 follows	PT 356 follows	PT 368 follows	PT 368 follows	PT 368 follows	PT 368 follows	PT 368 follows	PT 356 follows

1\* Publication .  
 2\* Plural strokes added secondarily.  
 3\* Publication .



	B9C	B10C	Sq3C	Sq4C	Sq5C	Sq6C
637c						
		ca. 5 groups lost				

Notes to p. 325:  
 1\* See also p. 348.  
 2\* Group with following.  
 2\* Remainder of col. and cols. 70-73 lost.  
 Pyr. 639b follows.



	B9C	B10C	Sq3C	Sq4C	Sq5C	Sq6C	Sq13C	Sq1Ch	Sq1Cop
638a									
638b 1*									
For notes see p. 324.									

	B9C	B10C	Sq3C	Sq4C	Sq5C	Sq6C	Sq13C	Sq1Ch
638c								
				ca. 6 groups lost			ca. 11 groups lost	
638d								
639a								

1\* Group with preceding.  
2\* See also p. 398.

	B9C	B10C	Sq3C	Sq4C	Sq5C	Sq6C	Sq13C	Sq1Ch	Sq1Cop
(639a)							 ca. 11 groups lost	 - 52 -	
639b					 ca. 6 groups lost			 sic	
1*						 - 147 -	 ca. 12 groups lost	 - 74 -	
						 - 56 -		 - 53 -	
	PT 369 follows	PT 369 follows	PT 589 follows	PT 589 follows	PT 589 follows	PT 589 follows	PT 369 follows	PT 447 follows	PT 213 follows

1\* See also p. 398.

	B9C	B10C	Sq13C
640a	- (359) - 	- (446) - 	- (58) - 
	ca. 6 groups lost	ca. 9½ groups lost	
640b			
		ca. 11 groups lost	
641a			

	B9C	B10C	Sq13C
(641a)			
641b			
		ca. 6½ groups lost	
642a			
642b			

	B9C	B10C	Sq13C
(642a)	- 361 - 		
642b			
643a			

	B9C	B10C
643b		- 448 - 
	ca. 9 groups lost	
643c		- 362 - 
		ca. 10 groups lost

1\* Remainder of col. lost. Ca. 10 cols. lost to end of Lid.

(PT 369)

	B9C	B10C
644a		

ca. 6 groups lost

	B9C	B10C
644b		

ca. 5 groups lost

	B9C	B10C
(644b)		

ca. 10 groups lost

	B9C	B10C
644e		

-449-  
-363-  
PT 423 follows PT 423 follows

PT 370

	B9C	B10C	B16C
645a			

-(365)- -451- -43b-  
-366-

	B9C	B10C	B16C
645b			

ca. 11 groups lost

	B9C	B10C	B16C
(645c)			

645d

	B9C	B10C	B16C
646a			

ca. 6 1/2 groups lost  
-44a-

645c

646b

	B9C	B10C	B16C
646c			
646d			
(646d)			
647a			
647b			
647c			
647d			
			PT 371 follows
			PT 371 follows

ca. 9 groups lost

ca. 13½ groups lost

PT 371

	B9C	B10C
648a		
(648a)		
648b		
648c		

ca. 12½ groups lost

-455-

-369-

1\* Group with following.

2\* Group with preceding.

3\* ( ) for .

4\* A variant of PT 371 follows (see p. 332).

	B9C	B10C	Sq13C
648d			
649a			

1\* PT 364 (Pyr. 612b) precedes.  
 2\* PT 364 (Pyr. 613c) follows.

	B9C	B10C	Sq13C
649b			
649c			
649d			

	B9C	B10C	Sq13C
650a			
650b			

	B9C	B10C
650c		
	PT 372 follows	PT 372 follows

B16C

648b

- (41a) -

B16C

650b

- 42a -

B16C

650c

- 40a -

B16C

649d

B16C

649b

- 38b -

B16C

649a

- 39a -

B16C

649c

B16C

644d

648c

648a

648d

644e

1\*

1\* An unidentified spell follows (beginning a variant of PT 372: see p. 444).

PT 372

B9C B10C

651a

- (370) -

- (454) -

- 455 -

- 371 -

B9C B10C

651b

ca. 10 groups lost

B9C B10C

651c

(651c)

B9C B10C

651c

652a

ca. 14 1/2 groups lost



(PT 372)

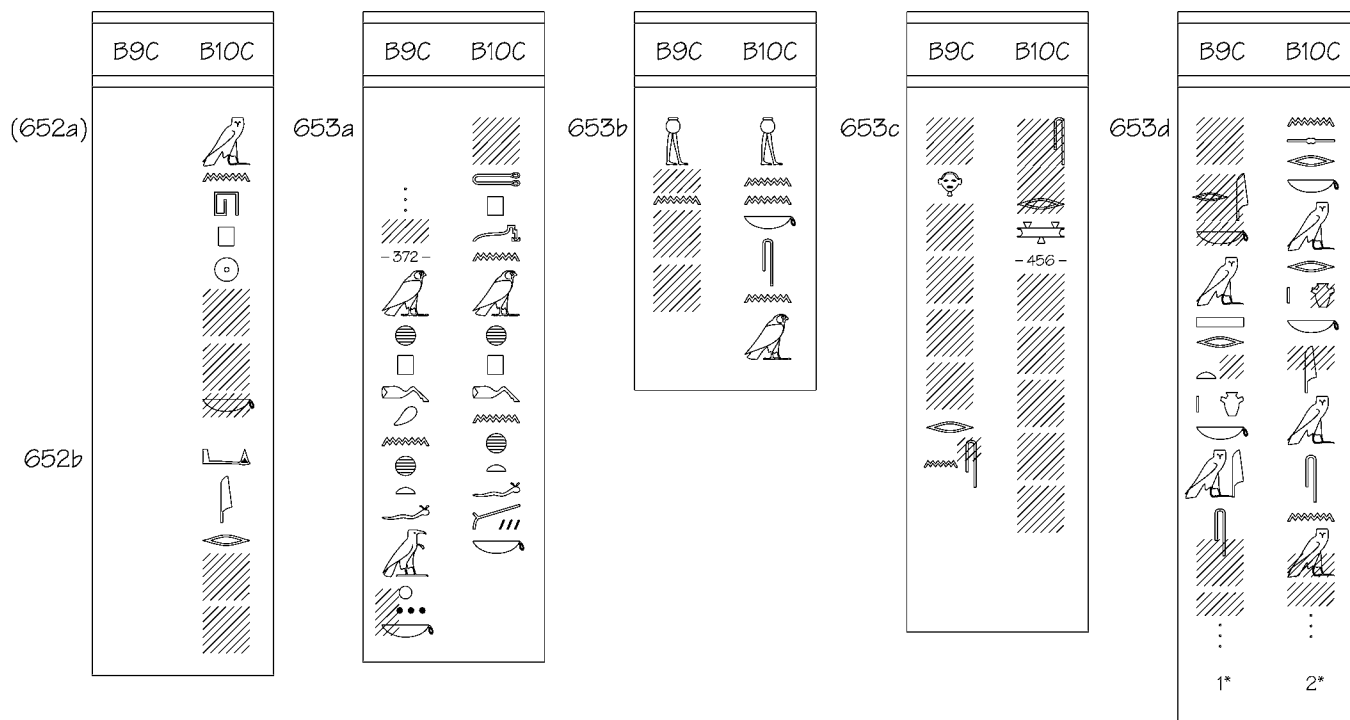

PT 373

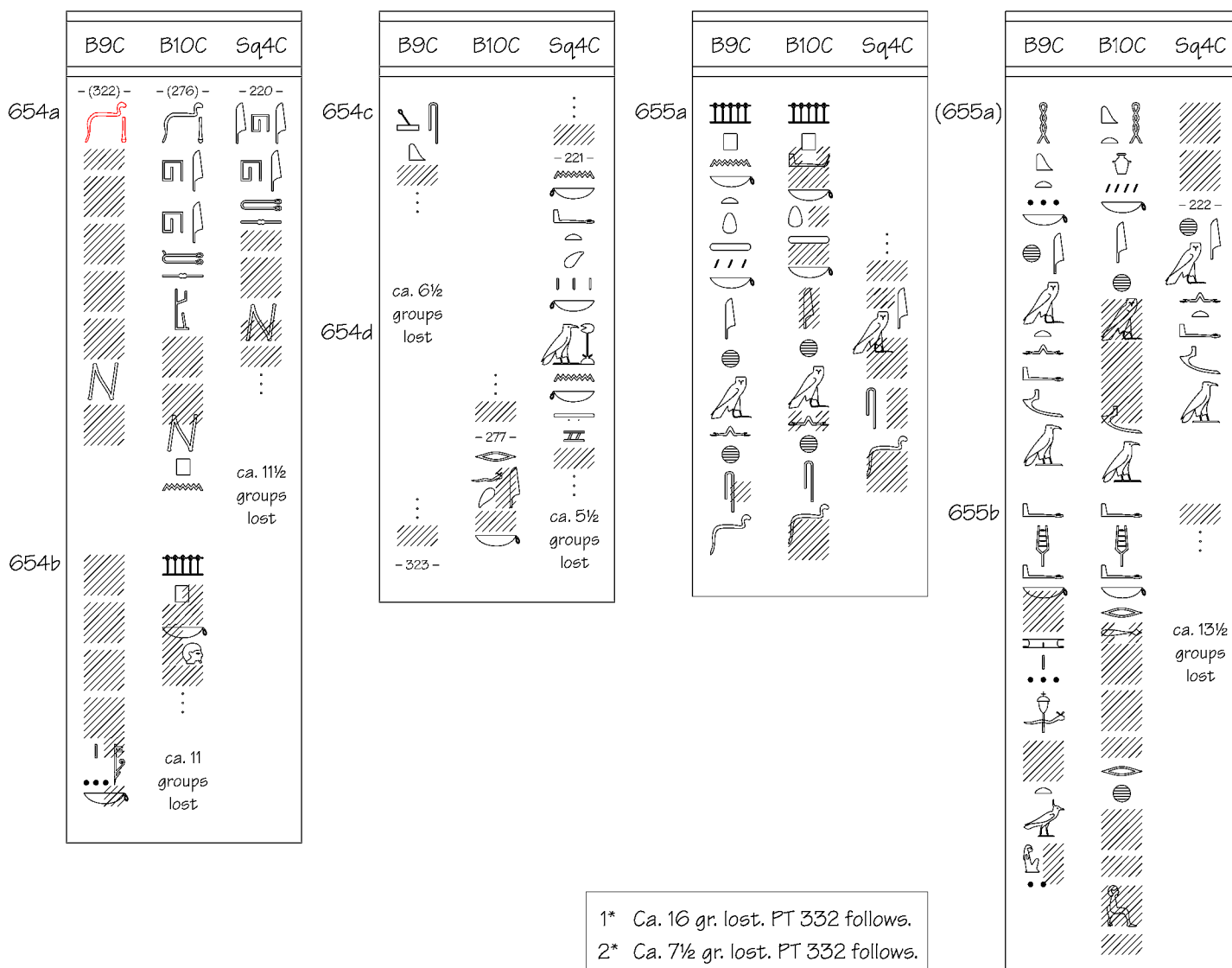

1\* Ca. 16 gr. lost. PT 332 follows.  
 2\* Ca. 7½ gr. lost. PT 332 follows.

	B9C	B10C	Sq4C
655c			
	ca. 10 groups lost		ca. 13½ groups lost
655d			
	ca. 5 groups lost		
656a			

	B9C	B10C	Sq4C
(656a)			
			ca. 14 groups lost
		ca. 6½ groups lost	
656c			
656d			
		ca. 13½ groups lost	
656e			
657a			
657b			
			ca. 16 groups lost

	B9C	B10C	Sq4C
656e			
657a			
657b			

	B9C	B10C	Sq4C
657c			
657d			
		ca. 7 groups lost	
657e			
	ca. 14½ groups lost		
	CT 516 follows	CT 516 follows	CT 516 follows

	B9C	B10C <sup>a</sup>	B10C <sup>b</sup>
658a	(339)	(287)	(429)
658b			
658c			

	B9C	B10C <sup>a</sup>	B10C <sup>b</sup>
658d			
658e			
659a			

	B9C	B10C <sup>a</sup>	B10C <sup>b</sup>
659b			
659c			

	B9C	B10C <sup>a</sup>	B10C <sup>b</sup>
659d			
	CT 517 follows	CT 517 follows	CT 517 follows







ca. 11½ groups lost





















































ca. 9 groups lost



















































ca. 8 groups lost























































ca. 9 groups lost























































ca. 6½ groups lost

	B9C	B10C
721a	- (387) - 	- (467) - 
721b	 	ca. 7 groups lost ...
721c		
721d	ca. 6 groups lost ...	ca. 7 groups lost ...
722a	ca. 10 groups lost ...	ca. 5½ groups lost ...

	B9C	B10C
722b	- 388 - 	
722b		
722b		
722b		
722b		
722b		
722b		- 468 - 
722b		
722b		
722b		
722b		
722b		
722b		
722b		
722b		
722b		
722b		
722b		
722b		
722b		
722b		ca. 6½ groups lost ...
722b		
722b		
722b		
722b		
722b		
722b		ca. 16½ groups lost ...

	B9C	B10C
722d		
723a		
723a		
723a		
723a		
723a		
723a		
723a		
723a		
723a		
723a		
723a		
723a		
723a		
723a		
723a		
723a		
723a		
723a		
723a		
723a		
723a		
723a		
723a		
723a		

	B9C	B10C
723c		
723c		
723c		
723c		
723c		
723c		
723c		
723c		
723c		
723c		
723c		
723c		
723c		
723c		
723c		
723c		
723c		
723c		
723c		
723c		
723c		
723c		
723c		
723c		
723c		
723c		
723c		

	B9C	B10C
(724b)		
(724b)	- 390 - 	
(724b)		
(724b)		
(724b)		
(724b)		
(724b)		
(724b)		
(724b)		
(724b)		
(724b)		
(724b)		
(724b)		
(724b)		
(724b)		
(724b)		
(724b)		
(724b)		
(724b)		
(724b)		
(724b)		
(724b)		
(724b)		
(724b)		
(724b)		
(724b)		
(724b)		

	B9C	B10C
725b	 ...  ca. 7 groups lost  	   
725c	...  	 
725d	-391-  	 
726a	   ca. 19 groups lost 	 

(726a)

726b

727a

	B9C	B10C
(726a)	 	 
726b	 	 
727a	 	 
	 -471- ... ca. 8½ groups lost 	 

727b

727c

728a

	B9C	B10C
727b	 -392- 	... 
727c	 	 
728a	  ca. 9 groups lost 	 
	  ca. 11½ groups lost 	 
	  ca. 8½ groups lost 	 

728b

728c

728c

	B9C	B10C
728b	  ca. 8 groups lost 	 
728c	 	 
728c	  -393- 	 
	  -472- 	 

729b

729c

730a

730b

	B9C	B10C
729b	 	 
729c	 	 
730a	  ca. 21½ groups lost 	 
730b	  ca. 10 groups lost 	 
	  -394- 	 

338

(PT 412)

	B9C	B10C
(730b)		
730c		
730d		

	B9C	B10C
731a		
731b		ca. 23 groups lost
731c	ca. 8 groups lost	

	B9C	B10C
732a		
732b		

	B9C	B10C
732c		
733a		

	B9C	B10C
733b		
733c		ca. 6 groups lost
733d	ca. 5 1/2 groups lost	

CT 519 follows

CT 519 follows

# PT 414

	T1C		T3Be
737c	<p>-(245)-</p>	737d	<p>PT 77 follows</p>

# PT 422

	B9C	B10C <sup>a</sup>	B10C <sup>b</sup>		B9C	B10C <sup>a</sup>	B10C <sup>b</sup>		B9C	B10C <sup>a</sup>	B10C <sup>b</sup>		B9C	B10C <sup>a</sup>	B10C <sup>b</sup>
752a	<p>-(530)-</p>	<p>-(281)-</p> <p>ca. 11½ groups lost</p>	<p>-(422)-</p>	(752b)		<p>...</p> <p>-(282)-</p>		753a	<p>ca. 11 groups lost</p>			753b	<p>...</p> <p>-(331)-</p>		

	B9C	B10C <sup>a</sup>	B10C <sup>b</sup>
753c			
			-423-
			ca. 10 groups lost
754a			
754b			
			ca. 6 groups lost
			ca. 11 groups lost

	B9C	B10C <sup>a</sup>	B10C <sup>b</sup>
(754b)			
754c			
			-332-
			-283-
755a			

	B9C	B10C <sup>a</sup>	B10C <sup>b</sup>
755b			
			-424-
755c			
			ca. 11½ groups lost

1\*

	B9C	B10C <sup>a</sup>	B10C <sup>b</sup>
756a			
			-333-
			ca. 5 groups lost
756b			
756c			
			-284-



	B9C	B10C <sup>a</sup>	B10C <sup>b</sup>
757a			
	ca. 9 groups lost		
757b			
	ca. 5½ groups lost		
757c			
	ca. 5 groups lost		

	B9C	B10C <sup>a</sup>	B10C <sup>b</sup>
758a			
758b			
	ca. 9 groups lost		
758c			
	ca. 4 groups lost		

	B9C	B10C <sup>a</sup>	B10C <sup>b</sup>
(758c)			
758d			
759a			
	ca. 11 groups lost		
	ca. 6 groups lost		

	B9C	B10C <sup>a</sup>	B10C <sup>b</sup>
759b			
759c			

342

(PT 422)

	B9C	B10C <sup>a</sup>	B10C <sup>b</sup>	Sq10C
760a				 - (164) -   165  1* - 166 - 
760b				 - 427 -   - 167 -    

	B9C	B10C <sup>a</sup>	B10C <sup>b</sup>	Sq10C
760c				
761				

1\* Like ; not or

2\*

3\* End of col. and register.  
PT 447 follows in next register.

	B9C	B10C <sup>a</sup>	B10C <sup>b</sup>
762a			
762b			
762c			

ca. 5 groups lost

ca. 6 groups lost

ca. 8 1/2 groups lost

ca. 6 1/2 groups lost

ca. 8 groups lost

- 338 -

	B9C	B10C <sup>a</sup>	B10C <sup>b</sup>
763a			
		ca. 12 groups lost	
763b			
		-287-	ca. 8 groups lost

	B9C	B10C <sup>a</sup>	B10C <sup>b</sup>
763c			
		-429-	ca. 8 groups lost

	B9C	B10C <sup>a</sup>	B10C <sup>b</sup>
763d			
		ca. 6 groups lost	
764a			

	B9C	B10C <sup>a</sup>	B10C <sup>b</sup>
(764a)			
		-339-	ca. 8½ groups lost
764b			
	PT 374 follows	PT 374 follows	PT 374 follows



	B9C	B10C <sup>a</sup>	B10C <sup>b</sup>
768a	-(344)- 	-(231)- 	-(434)- 
	ca. 4½ groups lost		
	-345- 		ca. 6½ groups lost
768b			

	B9C	B10C <sup>a</sup>	B10C <sup>b</sup>
(768b)			
		ca. 9 groups lost	
769a			
		-292- 	
	ca. 9 groups lost		

	B9C	B10C <sup>a</sup>	B10C <sup>b</sup>
769b			-435- 
	-346- 		
769c			ca. 6½ groups lost
769d			

	B9C	B10C <sup>a</sup>	B10C <sup>b</sup>
770a			
	ca. 9 groups lost		
770b			
	-347- 		ca. 6½ groups lost
	ca. 9½ groups lost		
770c			-436- 
			ca. 4½ groups lost
	-293- 		

770a

B9C	B10C <sup>a</sup>	B10C <sup>b</sup>
ca. 6½ groups lost		
- 348 -		

771b

B9C	B10C <sup>a</sup>	B10C <sup>b</sup>
ca. 5 groups lost		
- 294 -		

772b

B9C	B10C <sup>a</sup>	B10C <sup>b</sup>
ca. 7½ groups lost		
- 349 -		
ca. 5½ groups lost		
- 438 -		

774a

B9C	B10C <sup>a</sup>	B10C <sup>b</sup>
ca. 4½ groups lost		
PT 366 follows	PT 366 follows	PT 366 follows







	L-MH1A <sup>a</sup>	L-MH1A <sup>b</sup>	L3Li	Sq3C <sup>a</sup>	Sq3C <sup>b</sup>	Sq4C <sup>a</sup>	Sq4C <sup>b</sup>	Sq5C <sup>a</sup>	Sq5C <sup>b</sup>	Sq6C <sup>a</sup>	Sq6C <sup>b</sup>	Sq7C	T1Be	T1C	
778a	- (W 6) - 	- (L 79) -  ca. 9 groups lost	- (4) -  2*	- (133) -  -134- 	- (163) - 	- (93) -  -127- 	- (34) -  	- (62) - 	- (152) -  	- (152) - 	- (152) - 	- (152) - 	- Ext. Fr. - 	- (104) - 	- (113) - 
778b		 3*  4*  - L 80 -  5*				 -94- 	 	 ca. 6½ groups lost	 				 - (104) - 		
	PT 447 follows	PT 447 follows	PT 447 follows	PT 447 follows	PT 429 follows	PT 447 follows	PT 429 follows	PT 447 follows	PT 429 follows	PT 447 follows	PT 429 follows	PT 447 follows	End of line and Front	PT 449 follows	PT 447 follows

1\* Corrected over .  
 2\* To left of final of N.  
 3\* Publication .  
 4\* Publication .  
 5\* Publication .

779a-b

L-S1B	Sq3C	Sq4C	Sq5C	Sq6C	Sq7C
-Ext. L-	-164-	-128-	-(62)-	-(153)-	-Ext. B-

# PT 431

351

781a

Sq3C	Sq4C	Sq5C	Sq6C
- (165) -	- (129) -	- (64) -	- (155) -

(781a)

Sq3C	Sq4C	Sq5C	Sq6C
			ca. 6 groups lost

781b

Sq3C	Sq4C	Sq5C	Sq6C
PT 432 follows	PT 432 follows	PT 432 follows	PT 432 follows

# PT 432

782a

Sq3C	Sq4C	Sq5C	Sq6C
- (166) -	- (130) -	- (65) -	- (157) -

782a-b

Sq3C	Sq4C	Sq5C	Sq6C

781b

Sq3C	Sq4C	Sq5C	Sq6C
		ca. 6 groups lost	

352

(PT 432)

782c

Sq3C	Sq4C	Sq5C	Sq6C

782d

Sq3C	Sq4C	Sq5C	Sq6C

782e

Sq3C	Sq4C	Sq5C	Sq6C

PT 433 follows PT 433 follows PT 433 follows PT 433 follows

- 1\* Group with following.
- 2\* Group with preceding.
- 3\* Group with following (Pyr. 784a in PT 434).

PT 433

783a/783b

S1C	S10C	Sq3C	Sq4C	Sq5C	Sq6C

783b/783a

S1C	S10C	Sq3C	Sq4C	Sq5C	Sq6C

PT 434 follows PT 434 follows PT 434 follows PT 434 follows PT 434 follows PT 434 follows



	S1C	Sq3C	Sq4C	Sq5C	Sq6C
785c	-Ext. B 4-				

	Sq3C	Sq4C	Sq5C	Sq6C
785d				

ca. 5 groups lost

PT 443 follows

PT 443

	S1C	S2C	Sq3C	Sq4C	Sq5C	Sq6C
823a	-Ext. H 2-	-Ext. H 3-	-(171)-	-(136)-	-(70)-	-163-

	S1C	S2C	Sq3C	Sq4C	Sq5C	Sq6C
823b		-Ext. H 4-				

ca. 5 groups lost

-Ext. H 4-

1\* CT Temp. 252 follows (see p. 453).

	S1C	S2C	Sq3C	Sq4C	Sq5C	Sq6C
823c						
823d						

	Sq3C	Sq4C	Sq5C	Sq6C
823e				
	PT 444 follows	PT 444 follows	PT 444 follows	PT 444 follows

1\* One more col. of titles and N follow to end of Ext. Head.





	L- MH1A <sup>a</sup>	L- MH1A <sup>b</sup>	L3Li	Sq3C	Sq4C	Sq5C	Sq6C	Sq13C	T1C
825a	- (W 3) - 	- (L 77) - ... ca. 8½ groups lost	- 1 - <sup>1*</sup>	- 132 - 	- (91) - 	- (32) - ... ca. 6 groups lost	- (111) - 	- (4) - 	- 110 - 
825b									
								ca. 7½ groups lost	

1\* Publication for and for .

2\* To left of final of N.

	L-MH1A <sup>a</sup>	L-MH1A <sup>b</sup>	L3Li	Sq3C	Sq4C	Sq5C	Sq6C	Sq13C	T1C
825c	<p>-W5-</p>		<p>...</p> <p>-L7b-</p>						
825d		<p>ca. 8½ groups lost</p>						<p>...</p> <p>-6-</p>	<p>-112-</p>
	PT 449 follows	PT 449 follows	PT 449 follows	PT 449 follows	PT 449 follows	PT 448 follows	PT 448 follows	PT 449 follows	PT 449 follows

1\* Group with following (Pyr. 831 in PT 449).

826a

L-MH1A <sup>a</sup>	L-MH1A <sup>b</sup>	L3Li	M2C	Sq3C	Sq4C	Sq5C	Sq6C	Sq13C	T1C <sup>a</sup>
- (W7) -	- (L 80) -	- (6) -	- 6 -	- (134) -	- (94) -	- (35) -	- (114) -	- 7 -	- (114) -
			↑ 						

1\* Pyr. 827a follows. See also p. 363 n. 1.  
 2\* Seen only by Maspero.

826b

	L-MH1A <sup>a</sup>	L-MH1A <sup>b</sup>	L3Li	Sq3C	Sq4C	Sq5C	Sq6C	Sq13C	T1C <sup>a</sup>

-95-  
ca. 6 groups lost

ca. 8½ groups lost

2\* -116-

1\* Publication .  
 2\* Seen only by Maspero.

827a

	L-MH1A <sup>a</sup>	L-MH1A <sup>b</sup>	L3Li	M2C	Sq3C	Sq4C	Sq5C	Sq6C	Sq10C <sup>a</sup>	Sq10C <sup>b</sup>	Sq12C	Sq13C	Sq1Ch	T1C <sup>a</sup>	

827b

1\* To left of final of N.  
 2\* Publication

	L-MH1A <sup>a</sup>	L-MH1A <sup>b</sup>	L3Li	M2C	Sq3C	Sq4C	Sq5C	Sq6C	Sq10C <sup>a</sup>	Sq10C <sup>b</sup>	Sq12C	Sq13C	Sq1Ch	T1C <sup>a</sup>
827c		 ca. 8½ groups lost	 -9-				 -118-			 -172-		 -55-		
		 -W11-				 -97-	 ca. 3½ groups lost					 ca. 7½ groups lost		
828a		 -L82-	 -10-						 -119-	 -173- 1*	 -10-			 sic
							 -37-	 -118-				 -10-		

1\* Cols. 173-174 completely lost. Pyr. 829d follows.

	L-MH1A <sup>a</sup>	L-MH1A <sup>b</sup>	L3Li	M2C	Sq3C	Sq4C	Sq5C	Sq6C	Sq10C <sup>a</sup>	Sq12C	Sq13C	Sq1Ch	T1C <sup>a</sup>	T1C <sup>b</sup>
(828a)														
828b														
828c														

1\* End of col. Text at right follows in col. 11, then CT 223.

2\* Dashed lines mark signs seen only by Maspero.



3\* AHG ("faint traces seem to suit"), but AdB as here (preserved sign "too long for O")—read

	L-MH1A <sup>a</sup>	L-MH1A <sup>b</sup>	L3Li	M2C	Sq3C	Sq4C	Sq5C	Sq6C	Sq10C <sup>a</sup>	Sq13C	Sq1Ch	T1C <sup>a</sup>	T1C <sup>b</sup>	
829a														A
829b														
829c														B

Notes to p. 365:

1\* End of col. and Head.

2\* Seen only by Maspero.

3\* Over an erasure.

4\* Dashed lines mark signs seen only by Maspero.

5\* Text B above intervenes.

1\* Dashed lines mark signs seen only by Maspero.

2\* Text A above follows before the remainder of Pyr. 829c.



(829c)

	L-MH1A <sup>a</sup>	L-MH1A <sup>b</sup>	L3Li	M2C	Sq3C	Sq4C	Sq5C	Sq6C	Sq10C <sup>a</sup>	Sq10C <sup>b</sup>	Sq13C	Sq1Ch	T1C <sup>a</sup>	T1C <sup>b</sup>
	-W14- 	 ca. 10 groups lost	 -13- 					 -120- 					 2* 	
829d	 3* -W15- 3* 	 -L84- 	 -14- 	 -100- 		 -39- 		 -122- 		 -175- 		 End of col. and Lid	 4* 	
									PT 448 follows	PT 448 follows				

For notes see p. 364.

	L-MH1A <sup>a</sup>	L-MH1A <sup>b</sup>	L3Li	Sq3C	Sq4C	Sq5C	Sq6C	Sq13C	T1C <sup>a</sup>	T1C <sup>b</sup>
829e	-w14- 	 ca. 9½ groups lost							-122- 	
	PT 449 follows	PT 450 follows	PT 449 follows	PT 448 follows	PT 448 follows	PT 448 follows	PT 448 follows	PT 448 follows	PT 449 follows	CT 835 follows

T1C <sup>b</sup>

1\* Text above intervenes, all but first sign seen only by Maspero.

	L-MH1A	L3Li	Sq3C <sup>a</sup>	Sq3C <sup>b</sup>	Sq4C <sup>a</sup>	Sq4C <sup>b</sup>	Sq5C	Sq6C	Sq10C <sup>a</sup>	Sq10C <sup>b</sup>	Sq13C	T1Be	T1C
830a	- (W17) - 	- 16 - 	- (140) - 	- (183) - 	- (100) - 	- (149) - 	- (39) - 	- (121) - 	- 123 - 	- (176) - 	- (13) -  ca. 6 groups lost	- (9) - 	- (123) - 
830b	- W18 - 											- 10a - 	
	PT 451 follows	PT 451 follows	PT 450 follows	PT 356 follows	PT 450 follows	PT 356 follows	PT 450 follows	PT 450 follows	CT 530 follows	PT 451 follows	PT 366 follows	PT 428 follows	PT 450 follows

Notes to p. 368:

- 1\* To left of final of N.
- 2\* Publication
- 3\* Publication
- 4\* Group with final sign (lost) of Pyr. 825d (PT 446).
- 5\* Seen only by Maspero.

1\* Publication (sic).

PT 449

831

L-MH1A <sup>a</sup>	L-MH1A <sup>b</sup>	L-MH1A <sup>c</sup>	L3Li <sup>a</sup>	L3Li <sup>b</sup>	Sq3C	Sq4C	Sq5C	Sq6C	Sq13C	T1Be	T1C <sup>a</sup>	T1C <sup>b</sup>
- (W5) - 	- (W17) - 	- L 79 - 	... - 4 - 	- (15) - 	- (133) - 	- (92) - 	- (33) - 	- (113) - 	- (6) - 	- (10c) - 	- (112) - 	- 123 - 
PT 428 follows	PT 448 follows	PT 428 follows	PT 428 follows	PT 448 follows	PT 428 follows	PT 428 follows	PT 428 follows	PT 428 follows	PT 447 follows	PT 448 follows	PT 428 follows	PT 448 follows

For notes see p. 367.

PT 450

832a



L-MH1A	L-PW1A	Sq2C	Sq3C	Sq4C	Sq5C	Sq6C	T1Be	T1C
- N 8 - 	- (W 68) - 	- (7) - 	- (140) - 	- (100) - 	- (39) - 	- (121) - 	- (4) - 	- (124) - 
	- W 69 - 	- 8 - 	- 101 - 	- 40 - 	- 122 - 			

(832a)

832b

	L-MH1A	L-PW1A	Sq2C	Sq3C	Sq4C	Sq5C	Sq6C	T1Be	T1C
						<i>see above</i>			
			2*						

	L-MH1A	Sq2C	Sq3C	Sq4C	Sq5C	Sq6C	T1Be	T1C	T1Be
833a		<sup>-10-</sup> 	<sup>-142-</sup> 						
		<sup>-11-</sup> 		<sup>-102-</sup> 	<sup>...</sup> <sup>-41-</sup> 		<sup>-3-</sup> 	<sup>-126-</sup> 	
		<sup>-12-</sup> 					<sup>-1-</sup> 		
		<sup>-13-</sup> 					<sup>1*</sup> 		
833b									
		<sup>-14-</sup> 				<sup>2*</sup> 		<sup>-127-</sup> 	

1\* Text above follows, then PT 77.  
 2\* "Not a stroke. It looks as if it were beg. of ; after beginning this scribe saw that he had to write  first" (AdB).

	L-MH1A	L-PW1A	Sq2C	Sq3C	Sq4C	Sq5C	Sq6C	T1C
(833b)								
833c								
834a								

1\* w3ꜥ added secondarily.





	L-MH1A	L-PW1A	Sq3C	Sq4C	Sq5C	Sq6C	T1C
835b							
	End of col. and Head						
835c							
836a							

	L-PW1A	Sq3C	Sq4C	Sq5C	Sq6C	T1C
836b						
836c						
	End of col. and Back			ca. 6 groups lost		

1\* Group with preceding.  
2\* Group with following.

	Sq3C	Sq4C	Sq5C	Sq6C	T1C
836d-e					
	PT 451 follows	PT 451 follows	PT 451 follows	PT 451 follows	PT 451 follows

PT 451

	Sq3C	Sq4C	Sq5C	Sq6C	Sq10C
837a	- (146) - 	- (107) - 	- (45) - ... ca. 7 groups lost ... 	- (129) - 	- (176) - 

	Sq3C	Sq4C	Sq5C	Sq6C	Sq10C
837b			- 46 - 		- 178 - ... 1* 

1\* Cols. 178-179 lost.  
Pyr. 839b follows.

	Sq3C	Sq4C	Sq5C	Sq6C <sup>a</sup>	Sq6C <sup>b</sup>
837c					
838a					

1\* Pyn. 839b of Sq6C<sup>a</sup> precedes.

	Sq3C	Sq4C	Sq5C	Sq6C <sup>a</sup>	Sq6C <sup>b</sup>
838b					
838c					

	L-MH1A <sup>a</sup>	L3Li	Sq3C	Sq4C	Sq5C	Sq6C <sup>a</sup>	Sq6C <sup>b</sup>	Sq10C	T1C	Sq10C
839a	<p>-(W18)-</p> <p>1*</p> <p>-W19-</p>	<p>-17-</p> <p>1*</p> <p>2*</p>	<p>-110-</p> <p>-149-</p>	<p>-110-</p>	<p>ca. 7 groups lost</p>	<p>-135-</p> <p>-132-</p>	<p>-135-</p> <p>-180-</p>	<p>-134-</p>	<p>-(133)-</p> <p>-134-</p>	<p>-183-</p> <p>End of col. and Bottom</p>
839b	<p>-W20-</p>	<p>-16-</p>	<p>see above</p>	<p>-45-</p>	<p>-45-</p>	<p>-181-</p>	<p>-181-</p> <p>-182-</p>	<p>-181-</p> <p>-182-</p>	<p>-181-</p> <p>-182-</p>	<p>-181-</p> <p>-182-</p>

1\* To left of final of N.

2\* Publication

3\* Pyr. 838a of Sq6C<sup>b</sup> follows.

4\* Text above follows.

	L-MH1A <sup>a</sup>	L-MH1A <sup>b</sup>	L3Li	Sq3C	Sq4C	Sq5C	Sq6C	T1C	
840a	—	-(L 84)- 							
840b									
840c									
	PT 452 follows	PT 452 follows	PT 452 follows	PT 367 follows	PT 367 follows	PT 367 follows	PT 367 follows	PT 452 follows	

ca. 7 groups lost

ca. 8½ groups lost

1\* To left of final  
 of N.

	L-MH1A <sup>a</sup>	L-MH1A <sup>b</sup>	L3Li	T1C
841a	- (W 21) - 	- (L 85) - 	- 20 - 	- 136 - 
841b				
842a			- 21 - 	

	L-MH1A <sup>a</sup>	L-MH1A <sup>b</sup>	L3Li	T1C
842b			7* 	
842c				
842d				

	L-MH1A <sup>a</sup>	L-MH1A <sup>b</sup>	L3Li	T1C
(842d)				- 140 - 
843a				

- 1\* To left of final of N.
- 2\* added secondarily.
- 3\* Publication .
- 4\* Publication .
- 5\* Publication .
- 6\* Group with following.
- 7\* Group with preceding.
- 8\* Publication .
- 9\* and seen only by Maspero.

843b

L-MH1A <sup>a</sup>	L-MH1A <sup>b</sup>	L3Li	T1C

(843b)

L-MH1A <sup>a</sup>	L-MH1A <sup>b</sup>	L3Li	T1C

PT 453 follows    PT 453 follows    PT 453 follows    PT 453 follows

1\* Publication for this group.

2\* To left of final of N.

3\* Publication .

4\* Maspero saw at end of col. 140, but AHG "there seems no room; the line is already quite a long one."

PT 453

844a

T1C

844b

--

(844b)

T1C

844c

--

845a

--

(845a)

T1C

845b

T1C

846a

L-MH1A <sup>a</sup>	L-MH1A <sup>b</sup>	L3Li	T1C

846b

--

PT 367 follows    PT 367 follows    PT 367 follows    PT 367 follows

380

PT 454

	Sq3C	Sq4C	Sq5C	Sq6C
847a	- (175) - 	- (140) - 	- (73) - 	- (167) - 
847b				

	Sq3C	Sq4C	Sq5C	Sq6C
(847b)			- 74 - 	
		- 142 - 		- 169 - 

	Sq3C	Sq4C	Sq5C	Sq6C
847c				
	PT 425 follows	PT 425 follows	PT 455 follows	PT 425 follows

PT 455

	Sq3C	Sq4C	Sq5C	Sq6C
848a	- (178) - 	- (144) - 	- 75 - 	- (170) - 

	Sq3C	Sq4C	Sq5C	Sq6C
848b		- 145 - 		
		- 179 - 		

	Sq3C	Sq4C	Sq5C	Sq6C
848c				
			- 76 - 	End of col. and Lid



	Sq3C	Sq4C	Sq5C
849a		-146- 	
849b			
849c			

ca. 8 groups lost

	Sq3C	Sq4C	Sq5C
850a			-77- 
850b			
850c			

ca. 8 groups lost

ca. 14½ groups lost

	Sq3C	Sq4C	Sq5C
851a	-182- 		
851b			

PT 448 follows

PT 448 follows

End of col. and Back







(PT 468)

904b

B9C	B10C
	ca. 7 groups lost
ca. 8 groups lost	

904c

B9C	B10C

905a

B9C	B10C
	ca. 12½ groups lost
ca. 17 groups lost	

905b

B9C	B10C
	ca. 12½ groups lost
ca. 17 groups lost	

905c

B9C	B10C
	ca. 12½ groups lost
	PT 412 follows

PT 532

1259 a

B10C	T9C

1259 b

B10C	T9C

1259 c

B10C	T9C

1260 a

B10C	T9C

1260 b

B10C	T9C
	ca. 9 groups lost

1\* Corrected out of .  
 2\* or the like, mistake for (AdB).

386

(PT 532)

	B10C	T9C
1261 a		

	B10C	T9C
1261 b		

	B10C	T9C
1261 c		
	CT 837 follows	CT 837 follows

1\* Corrected over □.  
 2\* In CT 44 (CT I 185f): "prob. scribe begins here at wrong end & began again with l. 1" (AdB). This is the last col. of the Head. Contiguous parts of CT I 185f precede and follow.  
 3\* Dashed lines mark signs seen only by Lacau.

PT 579

	B10C <sup>a</sup>	B10C <sup>b</sup>	Sq3C	Sq6C
1539 a				

	B10C <sup>a</sup>	B10C <sup>b</sup>	Sq3C	Sq6C
1539 b				
1539 c				

	B10C	Sq3C	Sq6C
(1539 c)			

	B10C	Sq3C	Sq6C
1540 a		-29-	
1540 b		-86-	
1541 a		1* 1* ca. 9 groups lost	

	B10C	Sq3C	Sq6C
1541 b		-30- -87-	
1541 c			

	B10C	Sq3C	Sq6C
1542 a			-88-
1542 b		-31- 2*	

	B10C	Sq3C	Sq6C
1542 b		3*	
	PT 358 follows	PT 358 follows	PT 358 follows

- 1\* Dashed lines mark signs seen only by Lacau.
- 2\* Group with following.
- 3\* Group with preceding.

	L- MH1A <sup>a</sup>	L- MH1A <sup>b</sup>	L- PW1A <sup>a</sup>	L-Snb2	Sq3C	Sq4C	Sq5C	Sq6C	Sq10C <sup>a</sup>	Sq10C <sup>b</sup>	Sq12C	Sq13C	T1C
1607 a	-W1- 	-(L 73)- 	-(55)- 	-1- 	-130- 	-89- 	-30- 	-109- 	-(85)- 	-110- 	-1- 	-1- 	-107- 
		ca. 9 groups lost 		-2- 								ca. 10 groups lost 	
		... 	... 									ca. 10 groups lost 	
		... 	... 									ca. 10 groups lost 	
		... 	... 									ca. 10 groups lost 	
		... 	... 									ca. 10 groups lost 	
		... 	... 									ca. 10 groups lost 	
		... 	... 									ca. 10 groups lost 	
		... 	... 									ca. 10 groups lost 	
		... 	... 									ca. 10 groups lost 	
		... 	... 									ca. 10 groups lost 	
		... 	... 									ca. 10 groups lost 	
		... 	... 									ca. 10 groups lost 	
		... 	... 									ca. 10 groups lost 	
		... 	... 									ca. 10 groups lost 	
		... 	... 									ca. 10 groups lost 	
		... 	... 									ca. 10 groups lost 	
		... 	... 									ca. 10 groups lost 	
		... 	... 									ca. 10 groups lost 	
		... 	... 									ca. 10 groups lost 	
		... 	... 									ca. 10 groups lost 	
		... 	... 									ca. 10 groups lost 	
		... 	... 									ca. 10 groups lost 	
		... 	... 									ca. 10 groups lost 	
		... 	... 									ca. 10 groups lost 	
		... 	... 									ca. 10 groups lost 	
		... 	... 									ca. 10 groups lost 	
		... 	... 									ca. 10 groups lost 	
		... 	... 									ca. 10 groups lost 	
		... 	... 										



	B14C	L-BnrA	L-D1	L-HM	L-KhPM2	L-Nnj1	L-PW1A <sup>b</sup>	L-WN1A	L-Wsr1	L2Li	M58C	T13C
1607 a	-L- 	-LA- 	-L- 	-LB- 	-(LB)- 	-LC- 	-L- 	-L- 	-C- 	-E- 	-I- 	-I- 
		 End of line and Lid						 End of line and Lid				
1607 b												
	End of line and Lid	End of line and Lid	PT 690 follows	PT 690 follows	PT 213 follows	End of line and Lid	End of line and Ceiling	End of line and Lid	End of line and frag.		PT 252 follows	

1\* omitted in publication.

	L-MH1A <sup>a</sup>	L-MH1A <sup>b</sup>	L-PW1A <sup>a</sup>	L-Snb2	Sq3C	Sq4C	Sq5C	Sq6C	Sq10C <sup>b</sup>	Sq12C	Sq13C	T1C
(1607 b)												
1608 a												
1608 b												
	PT 446 follows	PT 446 follows	PT 427 follows		PT 446 follows	PT 446 follows	PT 446 follows	PT 446 follows	PT 427 follows	PT 447 follows	PT 446 follows	PT 446 follows

ca. 9 groups lost

ca. 9 groups lost

1\* Group with following.  
 2\* Group with preceding.  
 3\* A *htp-dj-nswt* formula follows to end of text.

# PT 589

391

	Sq3C	Sq4C	Sq5C	Sq6C
1609 a	- (158) -	- (121) -	- 58 -	- (147) -

	Sq3C	Sq4C	Sq5C	Sq6C
1609 b				

	Sq3C	Sq4C	Sq5C	Sq6C
(1609 b)				
	- 159 -			

PT 590 follows    PT 590 follows    PT 590 follows    PT 590 follows

# PT 590

	Sq3C	Sq4C	Sq5C	Sq6C
1610 a	- (159) -	- (122) -	- (58) -	- (148) -

1610  
b

	Sq3C	Sq4C	Sq5C	Sq6C
1611 a				

	Sq3C	Sq4C	Sq6C
1611 b			

PT 426 follows    PT 426 follows    PT 426 follows

1\* Ca. 9 groups lost.  
PT 426 follows.

392

PT 591

	L-PW1A	Sq3C	T1C
1612 a	-w1-	-16-	-(242)-

	L-PW1A	Sq3C	T1C
1612 b	-w2-		

	L-PW1A	Sq3C	T1C
1613 a	-w3-		

	L-PW1A	Sq3C	T1C
1613 b	-w4-		

1\* seen only by Maspero.



	BH1Br	M28C	M37C	S1C	S10C
1615 a	-IE- 	-IE- 	-IE- 	-EE2- 	-IW- 
1615 b					
1615 c					
	End of line and section	End of line and section	End of line and section		

	S1C	S10C
1616 a		
1616 b		
1619 a	-EE3- 	
1619 b		
		End of line and section

	S1C
1619 c	-EE4- 
1616 c	-EE5- 
1617 a	
	-EE6- 

	S1C
1617 b	
1618 a	-EE7- 
1618 b	-EE8- 

	S1C
(1618 b)	
1620 a	
1620 b	-EE9- 
	-EE10- 
	End of col. and Front

	Ab1Le <sup>a</sup>	Ab1Le <sup>b</sup>	B9C	B10C	L-Nnj1	L1Li	Sq3Be	Sq3C	Sq4C	Sq9C	Sq10C	Sq1Cop
1627 a	-20- 	-77- 	-291- 	-(256)- 	-LB- 	-1- 	-1- 	-(198)- 	-157- 	-40- 	-144- 	-42- 
					ca. 11½ groups lost							
1627 b	-21- 	-78- 			3* 	6* 					-146- 	
					ca. 6½ groups lost							

1\* Traces indicate same text in cols. 59-x, mostly lost.  
 2\* Group with following.  
 3\* Group with preceding.  
 4\* Publication   
 5\* 1 gr. left blank.  
 6\* Publication for

	Ab1Le <sup>a</sup>	Ab1Le <sup>b</sup>	B9C	B10C	L-Nhjl	L1Li	Sq3Be	Sq3C	Sq4C	Sq9C	Sq10C	Sq1Cop	Sq9C
1628 a						... -2- ... ca. 9 groups lost							
1628 b						2*			-158- ... 				
						...							
1628 c						...							
	PT 213 follows					...							
						ca. 7 groups lost							

1\* 2 gr. left blank.  
 2\* End of line. Pyr. 1629a follows in line L E.  
 3\* Text above intervenes before Pyr. 1629a  
 4\* Remainder of col. lost. PT 367 follows in col. 46.



	Ab1Le <sup>b</sup>	B9C	B10C	L-Nnj1	L1Li	Sq3Be	Sq3C	Sq4C	Sq9C	Sq10C
1629 a										

	Ab1Le <sup>b</sup>	B9C	B10C	L-Nnj1	L1Li	Sq3Be	Sq3C	Sq4C	Sq9C	Sq10C		Sq10C
1629 <sup>c</sup>		 ca. 10 groups lost									639a	
1630 <sup>a</sup>				 ca. 6½ groups lost	 -5-	 -201-	 -160-			 -162- -163-		 ca. 5 groups lost -155-
			End of line and Lid									

1\* Group with following. Pyr. 1635a follows.  
 2\* Text above follows, then Pyr. 1630c.  
 3\* Pyr. 1630c-1631a precedes.  
 4\* Group with preceding.

	B9C	B10C	L1Li	Sq3Be	Sq3C	Sq4C	Sq9C	Sq10C
1630 b	<p>-293-</p>		<p>///</p> <p>...</p>					<p>-164-</p>
			<p>ca. 9 groups lost</p>					<p>PT 422 follows</p>
1630 c								<p>1*</p> <p>-156-</p>
			<p>-6-</p>	<p>-202-</p>	<p>-161-</p>			<p>-157-</p>

1\* See p. 398 n. 2.

	B9C	B10C	L1Li	Sq3Be	Sq3C	Sq4C	Sq9C	Sq10C
1630 d								
1631 a								

1\* Publication for .  
 2\* Pyr. 1633a beginning.  
 3\* Pyr. 1630a follows.

	B9C	B10C	L1Li	Sq3Be	Sq3C	Sq4C	Sq9C
1631 b		<p>-258-</p> <p>ca. 4 groups lost</p>					
1632 a							<p>-46-</p> <p>ca. 11 groups lost</p>
1632 b							<p>-5-</p> <p>ca. 9½ groups lost</p>

	B9C	B10C	L1Li	Sq3Be	Sq3C	Sq4C	Sq9C
1632 c							
1633 a							





	Ab1Le <sup>b</sup>	B9C	B10C	L1Li	Sq4C
1637 b					
		ca. 20 groups lost		- 11 -	
				2*	
	1*	PT 356 follows	PT 356 follows	3*	PT 356 follows

Notes to p. 403:

1\* Group with preceding  
Pyr. 1629c).

2\* Publication

3\* Publication

4\* End of col. and regis-  
ter. PT 213 follows in  
col. 49.

1\* An unidentified spell  
follows (see p. 443).

2\* Restore perhaps

3\* Ca. 11 gr. lost to end  
of col. Cols. 12-14  
contain an unidenti-  
fied spell, with signs  
facing in the opposite  
direction.



	M7C	T4Be	T1C
1799 a	-1-	-10-	-(250)-
1799 b			

	M7C	T4Be	T1C
1800 a		-13-	
1800 b		-14-	
1800 c			

	M7C	T4Be	T1C
(1800) c			
1801 a			
1801 b			
1801 c			

	T1C
A	
B	
C	

1\* Text A above intervenes.  
 2\* Text B above intervenes.  
 3\* Dashed lines mark signs seen only by Maspero.  
 4\* Text C above intervenes.

PT 220 follows

	M7C    T1C		M7C
(1801 c)		1802 a	
			(1801 c)
			M7C
			T1C

# PT 639

407

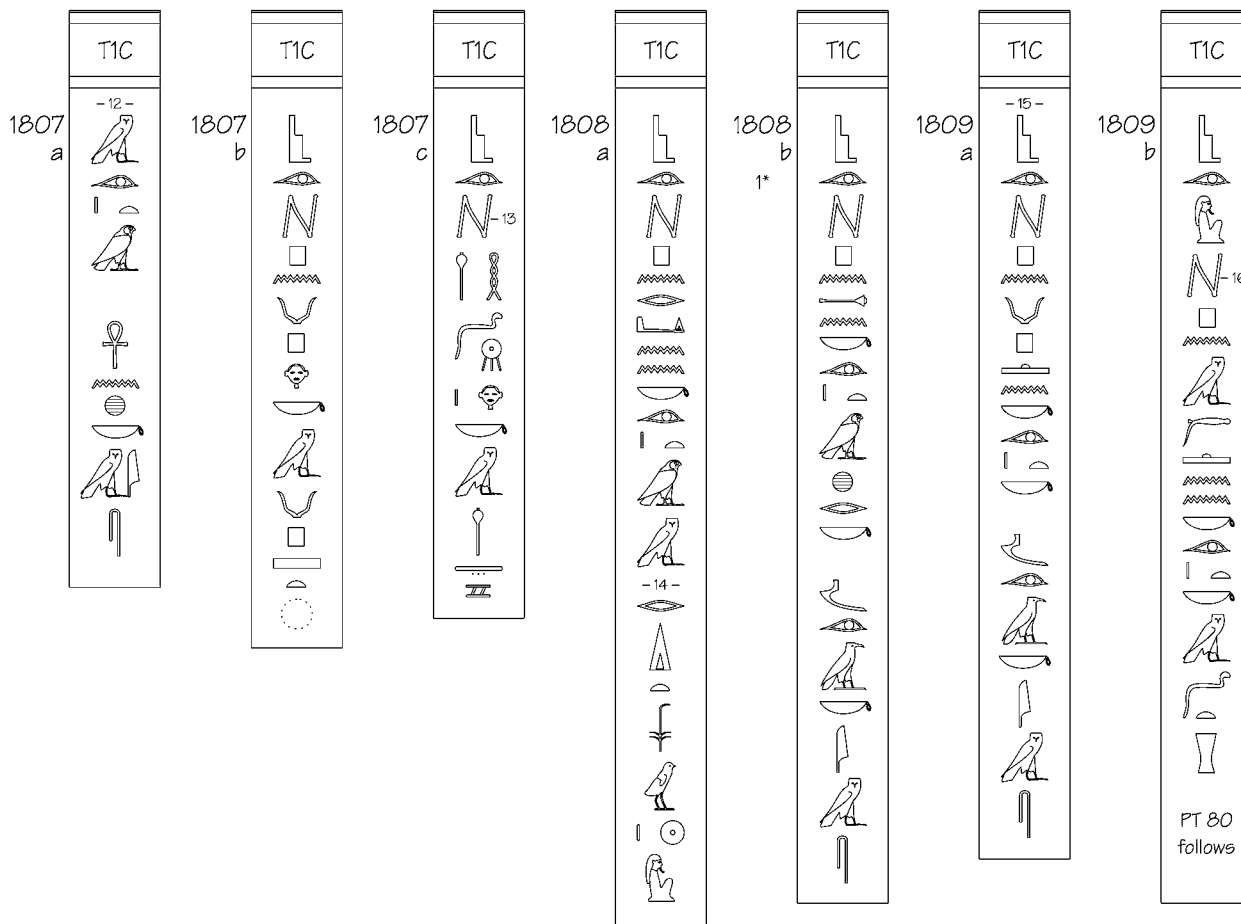

PT 80 follows

# PT 643B<sup>2\*</sup>

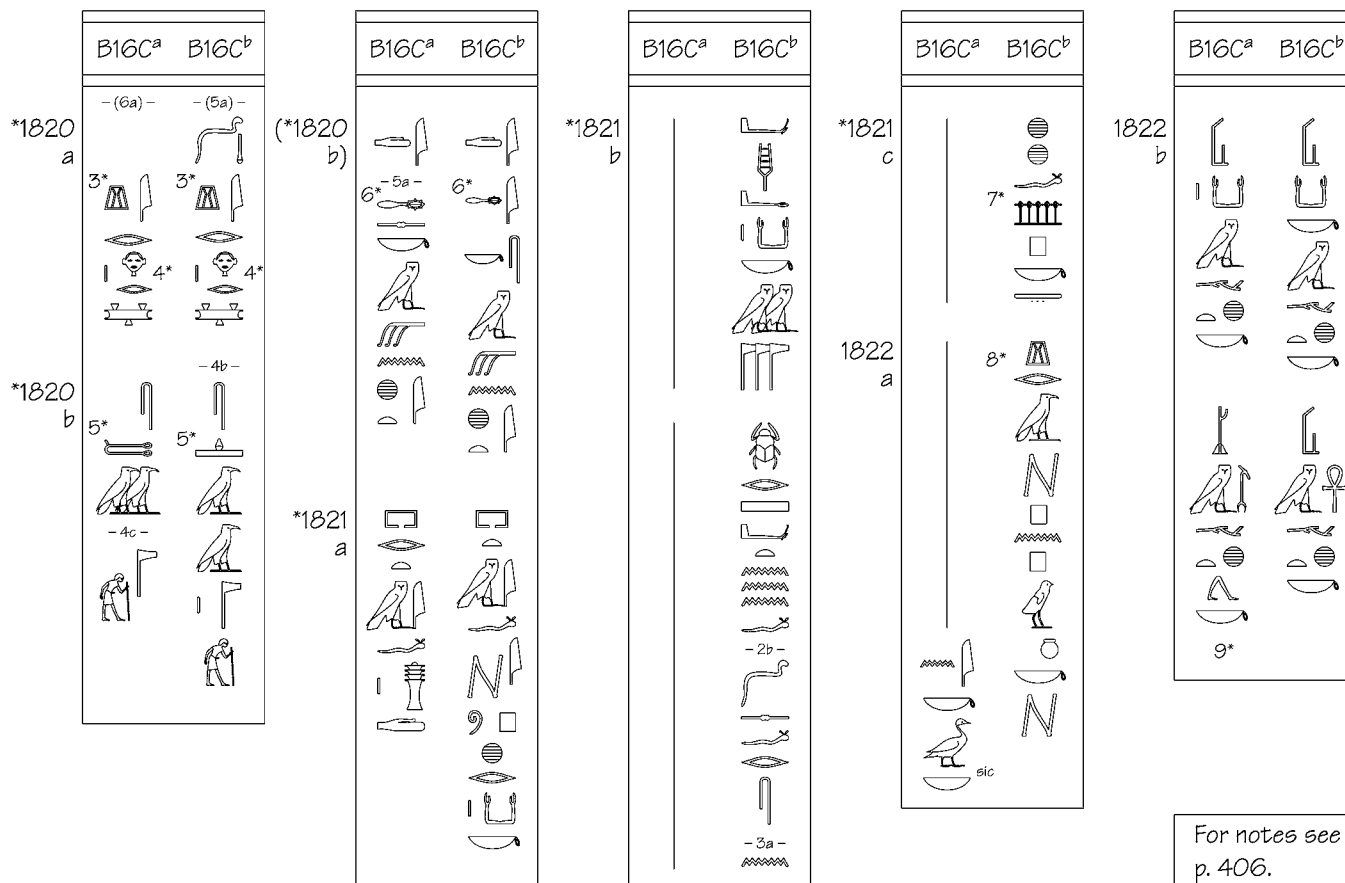

For notes see p. 406.





PT 646

	B4C	B16C	S10C	S14C
*1825 a	-(136)- 	-(58b)- 	-(271)- 	-(191)- 1* 
(*1825 a)				
*1825 b			-272- 	
	PT 645 follows	PT 647 follows	PT 647 follows	PT 647 follows

PT 647

	B16C	S10C	S14C		B16C	S10C		B16C	S10C		B16C	S10C		B4C
1826 a	-(58b)- 	-(272)- 	2* -(192)- 	ca. 12½ groups lost	3*	...	...	...	...	...	...	...	...	...
1826 b	-57b- 			ca. 5 groups lost	...	...	...	...	...	...	...	...	...	...
1827 a				ca. 5 groups lost	...	...	...	...	...	...	...	...	...	...
1827 b				PT 648 follows	PT 648 follows	PT 648 follows	PT 648 follows	PT 648 follows	PT 648 follows	PT 648 follows	PT 648 follows	PT 648 follows	PT 648 follows	PT 648 follows
*1827 c	-(138)- 			4*	...	...	...	...	...	...	...	...	...	...

1\* Published as CT VII 94d-e.  
 2\* Published as CT VII 94f.  
 3\* Ca. 11 gr. lost. PT 648 follows.  
 4\* Ca. 14 gr. lost. Restore m [c hftj.k] after Nt 362-63. PT 649 follows.

	B16C	S10C <sup>a</sup>	S10C <sup>b</sup>	S10C <sup>c</sup>	S10C <sup>d</sup>	S14C
*1828 a	-(56b)- 	-(269)- 	-(273)- 	-(275)- 	-(277)- 	-(192)- 1*
*1828 b						
*1828 c						

	B16C	S10C <sup>a</sup>	S10C <sup>b</sup>	S10C <sup>c</sup>	S10C <sup>d</sup>
1829 a					
1829 b					

1\* Published as CT VII 94g-h.  
 2\* Restore [L]W(t) after Nt 363.  
 3\* Ca. 14 gr. lost. CT VII 94h-l follows.  
 4\* PT 648 (S10C<sup>b</sup>) follows.  
 5\* Ca. 11 gr. lost. PT 649 follows.

PT 646 follows





# PT 649B-650

PT 649B

PT 650

B4C	B4C	B4C	B4C	B4C	B4C	B4C	B4C
<p>*1831 d</p> <p>- (138) -</p> <p>1*</p> <p>...</p> <p>*1831 e</p>	<p>*1832 a</p>	<p>*1832 b</p> <p>2*</p> <p>- 139 -</p> <p>*1832 c</p>	<p>*1832 d</p> <p>sic</p>	<p>*1832 e</p> <p>3*</p> <p>PT 650 follows</p>	<p>1833 a</p> <p>- (139) -</p> <p>4*</p> <p>...</p>	<p>1833 b</p>	<p>1833 c</p> <p>- 140 -</p> <p>CT 746 follows</p>

# PT 651-653C, 664B

PT 651

PT 652

PT 653C

PT 664B

M7C	M7C Sq3C	M7C Sq3C	B16C Sq3C	B16C Sq3C	L-PWIB
<p>1838</p> <p>- (54) -</p> <p>5*</p> <p>- 56 -</p> <p>PT 652 follows</p>	<p>1839 a</p> <p>- (56) -</p> <p>- (92) -</p> <p>6*</p> <p>- 57 -</p>	<p>(1839 a)</p> <p>7*</p> <p>8*</p>	<p>*1840 c</p> <p>- 31 -</p> <p>- (91) -</p> <p>9*</p> <p>- 92 -</p>	<p>(*1840 c)</p> <p>PT 58 follows</p> <p>PT 652 follows</p>	<p>*1885 a</p> <p>- L -</p> <p>*1885 c</p> <p>End of line and Lid</p>

For notes see p. 412.

	B4C	B10C <sup>a</sup>	B10C <sup>b</sup>	R1X	T1C <sup>a</sup>	T1C <sup>b</sup>	T9C	T1L
1972	- (68) - 	- (31) - ca. 5 groups lost 	- (373) - 	- (2) - 	- (100) - - 101 - 	- 177 - 	- (354) - 	- (239) - - 240 - 
1973 a	- 69 - 			- 3 - 			- 355 - 	

	B4C	B10C <sup>a</sup>	B10C <sup>b</sup>	R1X	T1C <sup>a</sup>	T1C <sup>b</sup>	T9C	T1L
1973 b								
1973 c								
1973 d								

ca. 10 groups lost

1\* Strokes added secondarily.  
 2\* added secondarily.

	B4C	B10C <sup>a</sup>	B10C <sup>b</sup>	R1X	T1C <sup>a</sup>	T1C <sup>b</sup>	T9C	T1L
1974 a	-70- 							
1974 b								
1974 c								

- 1\* Traces of Pyr. 1974-75 also in cols. 20-22 on the Foot.
- 2\* Group with following.
- 3\* Group with preceding.
- 4\* Canceled.

	B4C	B10C <sup>a</sup>	B10C <sup>b</sup>	R1X	T1C <sup>a</sup>	T1C <sup>b</sup>	T9C	T1L
1974 d				-7- 		-180- 		1* 
1975 a								
1975 b			-575- 					

1\* Group with preceding.  
 2\* seen only by Maspero.

	B4C	B10C <sup>a</sup>	B10C <sup>b</sup>	R1X	T1C <sup>a</sup>	T1C <sup>b</sup>	T9C	T1L
(1975 b)								
1976 a								
1976 b								

1\* Stroke added secondarily.

2\* added secondarily.

	B4C	B10C <sup>a</sup>	B10C <sup>b</sup>	R1X	T1C <sup>a</sup>	T1C <sup>b</sup>	T9C	T1L
1977 a								
				- 10 -	sic	- 182 -		
1977 b		—					—	
	1*			End of col. and Head				
1977 c				—			—	—
					2*	- 358 -		

1\* End of col. CT 191 follows.  
2\*







	B10C <sup>b</sup>	T1C <sup>b</sup>
1980 a		
1980 b		
1980 c		

	B10C <sup>a</sup>	B10C <sup>b</sup>	T1C <sup>b</sup>	T9C	T1L
1981 a					
1981 b					

	B10C <sup>a</sup>	B10C <sup>b</sup>	T1C <sup>b</sup>	T9C	T1L
1981 c					
1982 a					

ca. 12 groups lost

For notes see p. 421.

	B10C <sup>a</sup>	B10C <sup>b</sup>	T1C <sup>b</sup>	T9C	T1L
1982 b					
1983 a					
1983 b/c					

	B10C <sup>a</sup>	B10C <sup>b</sup>	T1C <sup>b</sup>	T9C	T1L
1983 c/b					
1983 a					

CT 335 follows

ca. 4½ groups lost

- 247 -

1\* Bird on left is hieroglyphic sign; bird on right added secondarily, in hieratic.

	B10C <sup>a</sup>	B10C <sup>b</sup>	T9C	T1L
1983 e				
1984 b				
1984 a				

	B10C <sup>a</sup>	T9C	T1L
1985 a			
1985 b-c			

	B10C <sup>a</sup>	T9C	T1L
1986 a			
1986 b			
	PT 532 follows	PT 532 follows	CT 179 follows

1\* Remainder of col.  
lost. CT 916 follows  
in next col.

PT 674<sup>1\*</sup>

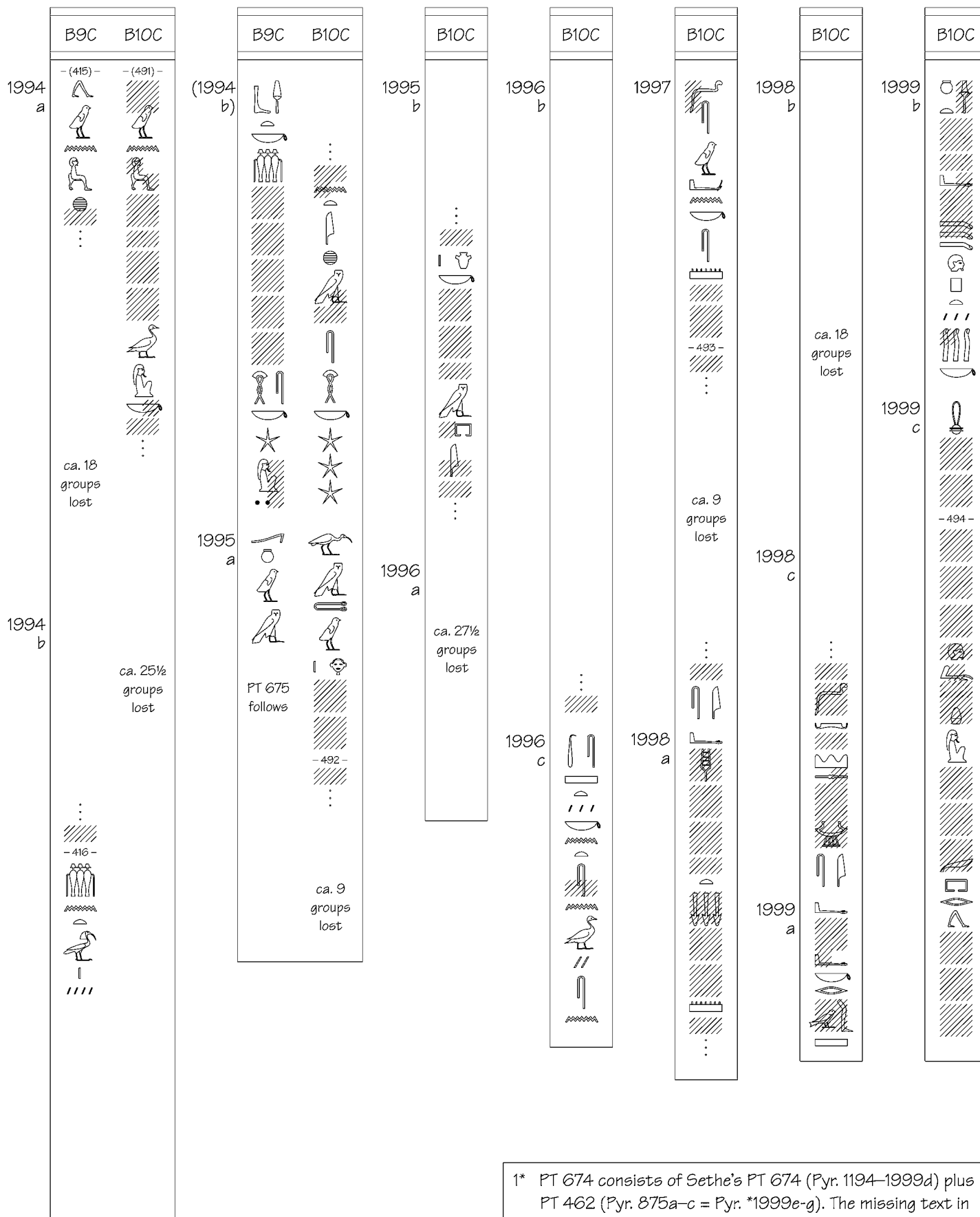

1\* PT 674 consists of Sethe's PT 674 (Pyr. 1194–1999d) plus PT 462 (Pyr. 875a–c = Pyr. \*1999e–g). The missing text in Sethe's publication (N 794–800) can be reconstructed after P F-A/N 1–14 and Nt 601–607, as follows:  
 1994a [jw.n.j hr.k jnk z3.k, jw.n.j hr].k N pn jnk hrw  
 1995a [gm.j tw, tz.j hr].k m z3b ph.k m qbhwt  
 1996b [hms r.k hr hndw.k] bj3jj hr nst hntj jmntjw  
 1999d hw.k [c.k jr mtw jr] 3hju ndrwt.sn c.k n hntj jmntjw.



	B9C	B10C		B9C	B10C		B9C	B10C		B9C	B10C		B9C	B10C	
2001 c		-496- 	2002 a			ca. 9 groups lost	2002 b			2003 a			2003 c		
2002 a			2002 c			ca. 15½ groups lost	2003 b			2003 b			2004 a		

(PT 675)

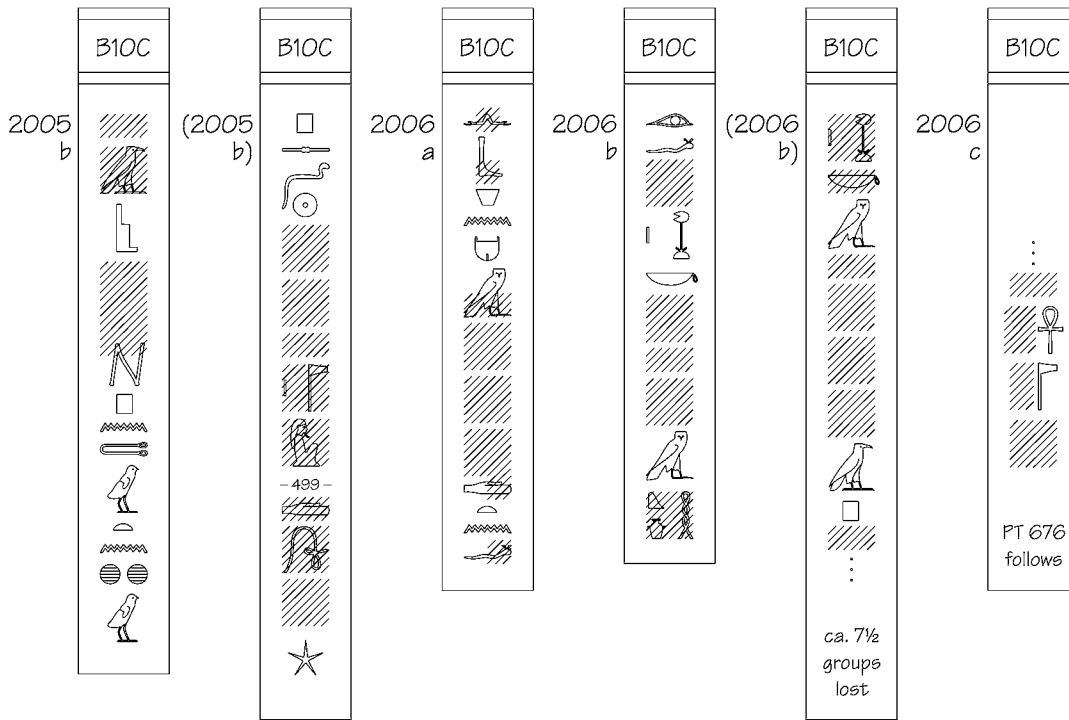

PT 676

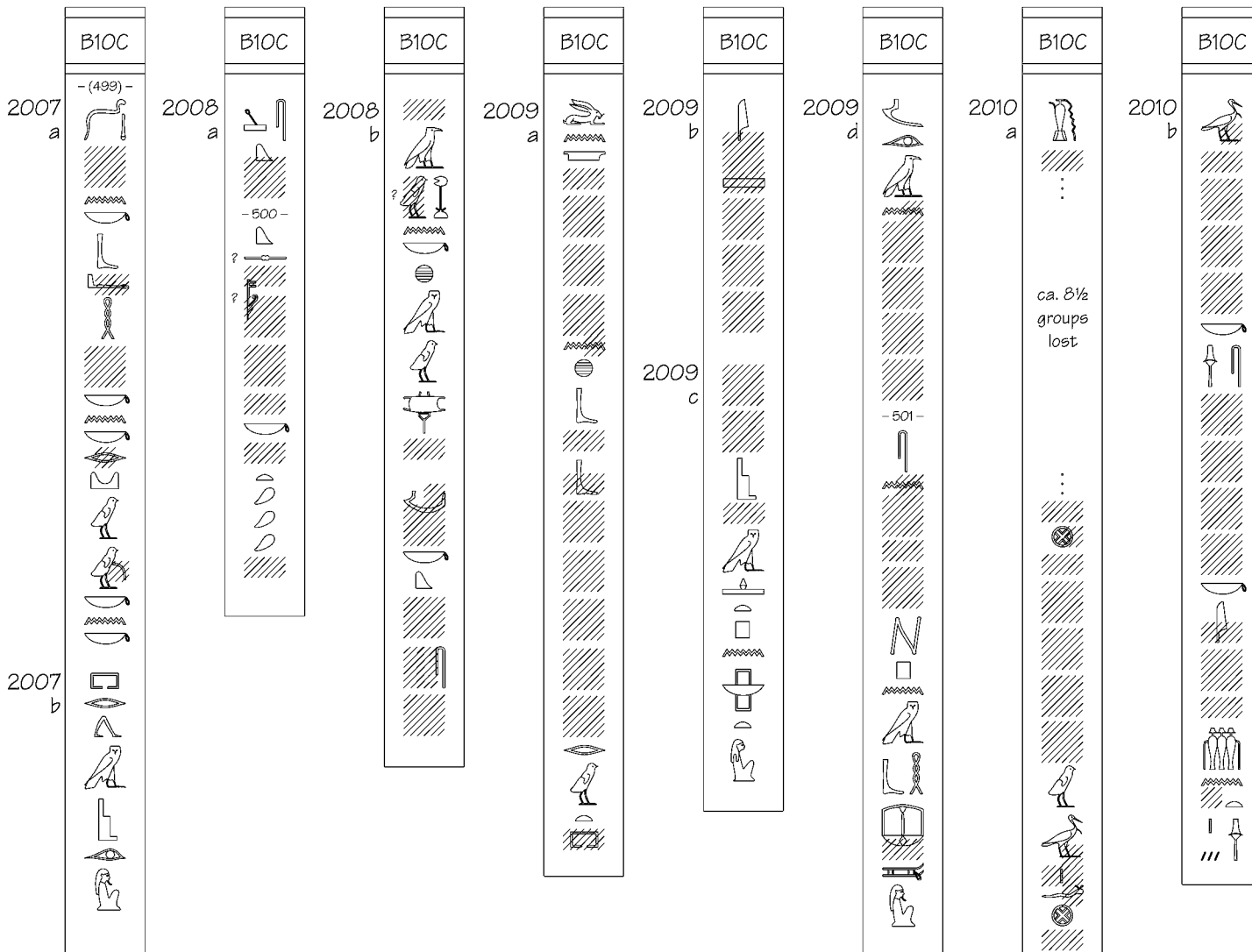



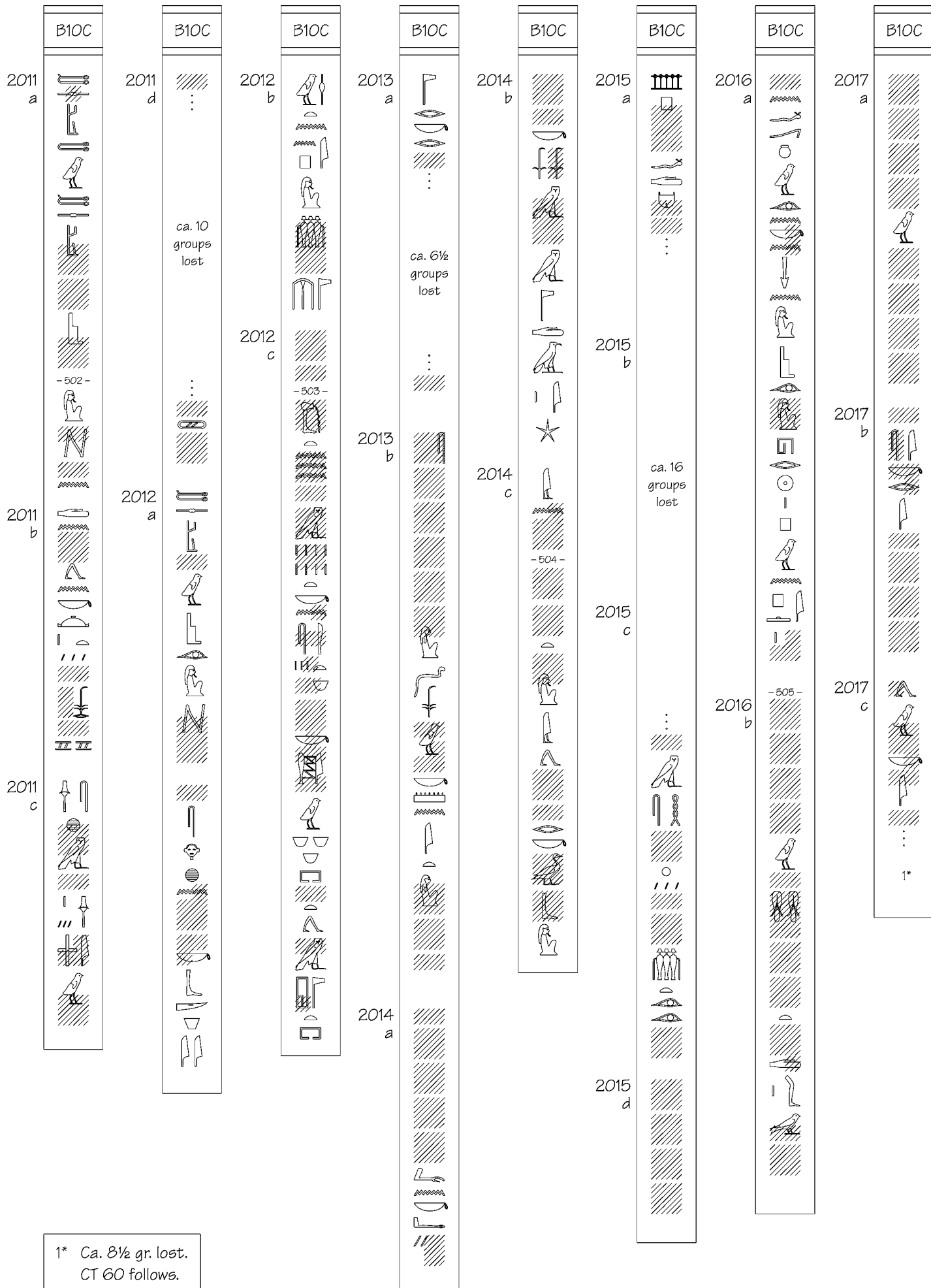

1\* Ca. 8½ gr. lost.  
CT 60 follows.

	B9C	B10C	Sq3Be	Sq4C
2018 a	- (312) - ...	- (269) - [Hieroglyphs]	- 9 - [Hieroglyphs]	- (198) - [Hieroglyphs]
2018 b		- 270 - [Hieroglyphs]	[Hieroglyphs]	[Hieroglyphs]
2019 a		[Hieroglyphs]	[Hieroglyphs]	[Hieroglyphs]

	B9C	B10C	Sq3Be	Sq4C
2019 b	[Hieroglyphs]	[Hieroglyphs]	[Hieroglyphs]	[Hieroglyphs]
2019 c	[Hieroglyphs]	[Hieroglyphs]	[Hieroglyphs]	[Hieroglyphs]

1\* Sign seen only by Lacau.  
 2\* Dashed lines mark signs seen only by Lacau.  
 3\* Pyr. 2022 follows.

	B9C	B10C	Sq4C
2020 a	[Hieroglyphs]	[Hieroglyphs]	[Hieroglyphs]
2020 b	[Hieroglyphs]	[Hieroglyphs]	[Hieroglyphs]
2021 a	[Hieroglyphs]	[Hieroglyphs]	[Hieroglyphs]

	B9C	B10C	Sq3Be	Sq4C
2021 b				
2022 a				
2022 b				

	B9C	B10C	Sq3Be	Sq4C
2023 a				

	B9C	B10C	Sq4C
2025 a			
2025 b			

ca. 7 groups lost

ca. 13½ groups lost

	B9C	B10C	Sq3Be	Sq4C
2026 a				
2026 b				

ca. 15 groups lost

	B9C	B10C	Sq3Be	Sq4C
2027 a				
2027 b				

ca. 11½ groups lost

PT 677B follows

PT 677B follows

PT 677B follows

1\* End of col. and register.  
Next register lost.

# PT 677B

	B6C	B9C	B10C	Sq4C
2028 a	(112)	(318)	(273)	(210)
		5 groups lost		ca. 14 groups lost

	B6C	B9C	B10C	Sq4C
(2028 a)				
2028 b		-319-	5 1/2 groups lost	
			-274-	
				5 groups lost
				1*

	B6C	B9C	B10C	Sq4C
2028 c				
				-212-
				ca. 11 1/2 groups lost
	PT 365 follows	PT 365 follows	PT 365 follows	PT 365 follows

1\* Or

# PT 686

	T1L
2071 a	(3)

	T1L
2071 b	

	T1L
(2071 b)	(4)
2071 c	

	T1L
2072 b	

	T1L
2072 c	(5)

	T1L
2072 d	

	T1L
2016 a	

	T1L
2017 a	(6)
	PT 81 follows



	B9C	B10C	B11C
2095 b	...		1* ...
	-401-		
2096 a	...		

1\* Dashed lines mark signs seen only by Lacau.

	B9C	B10C	B11C
2096 b			
		-479-	
2096 c			
	ca. 9½ groups lost		
2097 a			-17-
			ca. 26 groups lost

	B9C	B10C	B11C
(2097 a)			
	-402-		
2097 b			
	ca. 7 groups lost		
2097 c			
	ca. 15 groups lost		
			-18-

	B9C	B10C	B11C
2098 a			
		-480-	
2098 b			
		ca. 5 groups lost	
			-403-
			ca. 15 groups lost
			-19-
			ca. 7 groups lost

	B9C	B10C	B11C
2099 a			
	ca. 12 groups lost	ca. 8 groups lost	
2099 b			

	B9C	B10C	B11C	L-HM	L-KhPM2
2100 a					
	-404-	-481-		-LC-	-(LB)-
2100 b					
	ca. 24½ groups lost	ca. 32 groups lost		-LC-	
2100 c					
			-21-		

	B9C	B10C	B11C	L-HM	L-KhPM2
(2100 c)					
				End of line and Lid	End of line and Lid
2101 a					

1\* Dashed lines mark signs seen only by Lacau.  
 2\* PT 588 follows to end of this line.  
 3\* 3 gr. left blank (usually for N in this MS).





	B9C	B10C
2105 a		
2105 b		
2105 c		
	ca. 9½ groups lost	ca. 14 groups lost

	B9C	B10C
(2105 c)		
2106 a		
2106 b		
2107 a		
	ca. 8 groups lost	
		ca. 20 groups lost
		ca. 21 groups lost

	B9C	B10C
2107 b		
2107 c		
2108 a		
		ca. 9 groups lost
		ca. 21 groups lost

	B9C	B10C
(2108 a)		
2108 b		
2109 a		
		ca. 18 groups lost
		ca. 21 groups lost

	B9C	B10C
2110 a-b		
2110 c		
2110 d		
		ca. 29½ groups lost
		ca. 16 groups lost

	B9C	B10C
2111		
		-487-
		...
		-411-
		ca. 12 groups lost
		...
2112 a		...
		ca. 18½ groups lost
2112 b		...

	B9C	B10C
(2112 b)		...
2113		...
		ca. 15½ groups lost
2114 a		...
		ca. 10½ groups lost

	B9C	B10C
2114 b		...
		-412-
		...
2115 a		...
		ca. 17½ groups lost
2115 b		...

	B9C	B10C
(2115 b)		...
2116 a		...
		ca. 9½ groups lost
2116 b		...

	B9C	B10C
2116 c		...
		ca. 11 groups lost
2117		...

	B9C	B10C		B9C	B10C		B9C	B10C		B9C	B10C		B9C
2118 a													
	-414-												



N 216+22-29<sup>1\*</sup>

M7C

a

M7C

b

M7C

c

M7C

d

M7C

e

M7C

f

1\* Also Nt 47-49; cf.  
CT VII 63m-n.

2\* N 216+30-42 follows.

3\* Also Nt 49-52.

N 216+30-41<sup>3\*</sup>

M7C

g

M7C

h

M7C

i

M7C

j

M7C

k

M7C



l

M7C

m

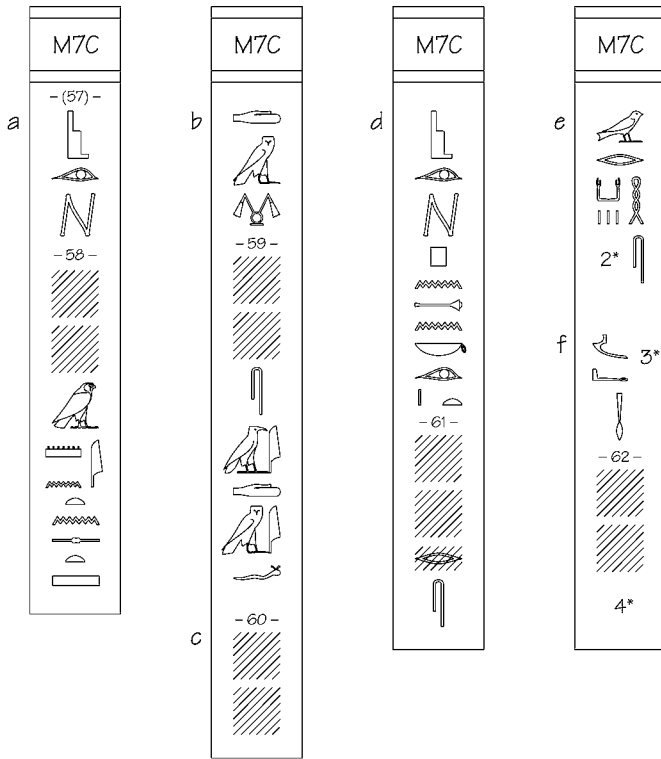
PT 651 follows



- 1\* Also Nt 56-63.
- 2\* Group with following.
- 3\* Group with preceding.
- 4\* Restore probably [N]. PT 226 follows.
- 5\* Cols. 112 bis and 113 are on the edge between the Foot and Back, cols. 114-115 on the edge between the Foot and Front.
- 6\*  reading uncertain.
- 7\* Lost group on peg: read [w]p(w)t(j)?
- 8\* For : cf. CT VI, 274o.
- 9\* End of edge inscription.

A1C Foot Edge Texts<sup>5\*</sup>

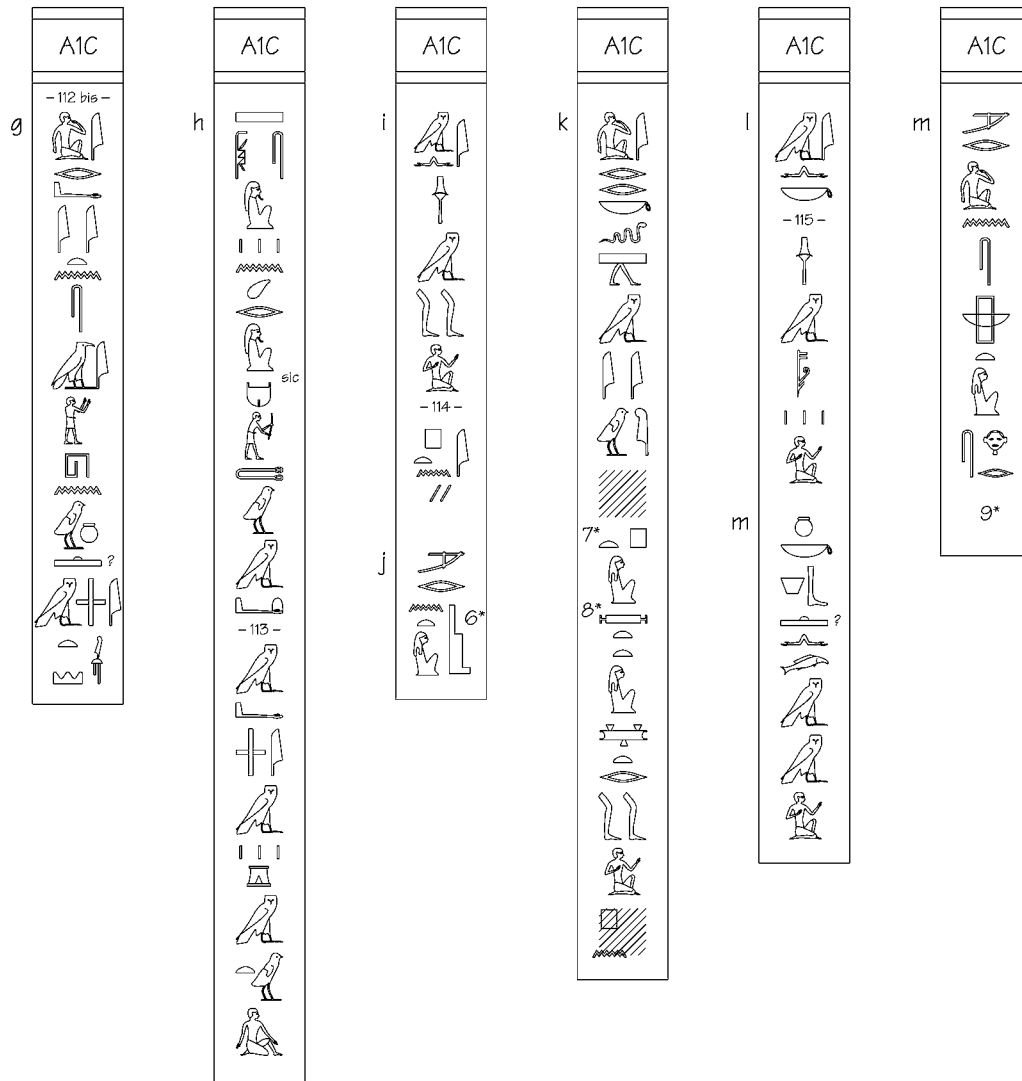

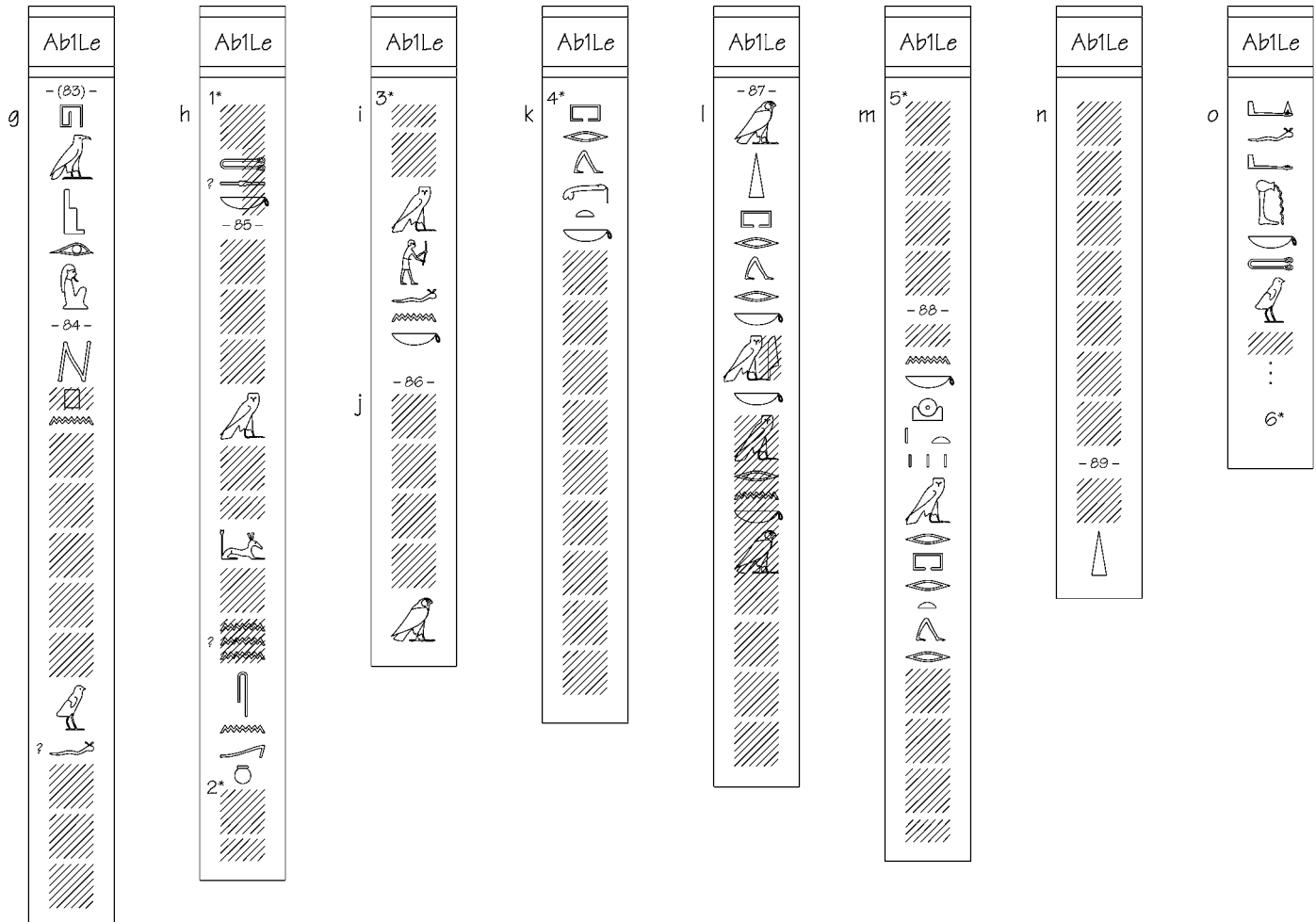

- 1\* Restore perhaps [w]tz.
- 2\* Restore perhaps snw[h].
- 3\* Restore perhaps [nj sh]m.f.
- 4\* For k-l cf. Pyr. 632b-c.
- 5\* Cf. Pyr. 585a.
- 6\* Ca. 11 gr. lost to end of col. and register. PT 213 follows in next register.

- Notes to p. 445:
- 1\* Lines 861-862 are painted hieroglyphs. Under them "probably a table with objects, but almost gone" (AdB).
  - 2\* 3ht added secondarily.
  - 3\* Edges as follows:  
 821-822 Head to Back  
 823-824 Head to Front  
 825-826 Foot to Front.



# B1Bo 861-864

a B1Bo -861-<sup>1\*</sup>

b B1Bo -863-

c B1Bo

d B1Bo -864-

e

f B1Bo

g B1Bo

h B1Bo

i

End of col. and Back

## B2Bo Edge Texts<sup>3\*</sup>

j B2Bo -821-

k

l B2Bo

m B2Bo -822-

End of Edge

n B2Bo -823-

o B2Bo

End of Edge

p B2Bo -825-

q B2Bo -826-

End of Edge

For notes see p. 444.

(B2Bo Edge Texts)<sup>1\*</sup>

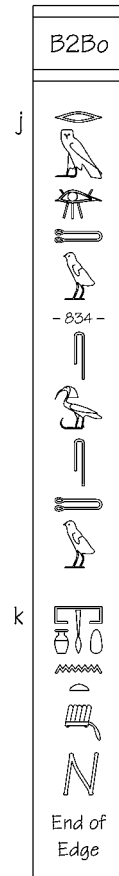
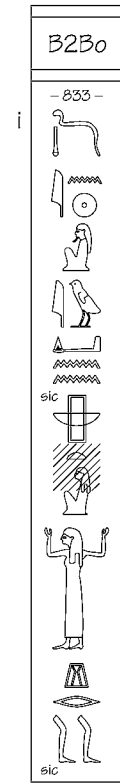
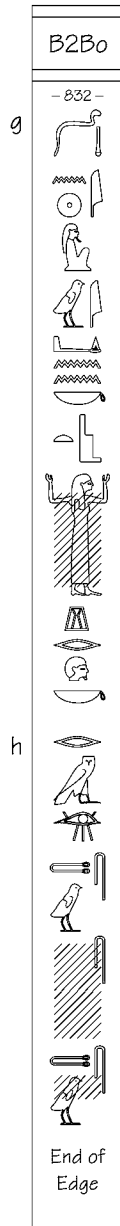
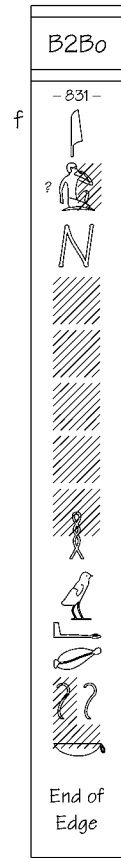
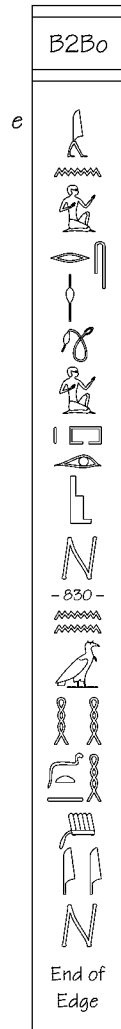
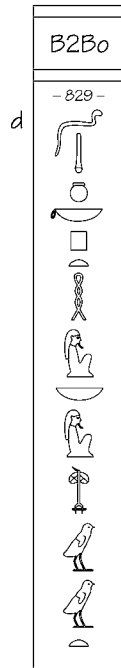
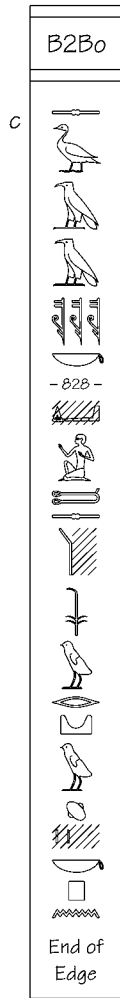
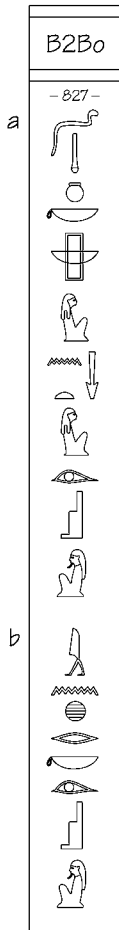

1\* Edges as follows:  
 827-828 Foot to Back  
 829-830 Back to Foot  
 831 Back to Head  
 832 Front to Head  
 833-834 Front to Foot.

	B16C
a	- (37c) - 
b	
c	
d	
e	

	B16C
f	- (36b) - 
g	
h	
i	
j	
k	
	- 37a - 

	B16C
l	
m	- 35b - 
n	
o	
p	- 36a - 

	B16C
q	
r	
s	- 34b - 
t	
u	
v	- 35a - 

	B16C
w	
x	
y	- 33b - 
z	
	- 34a - 
	1* 

	B16C
aa	2* 
bb	
cc	
dd	
	- 33a - 

	B16C
ee	
ff	
gg	
hh	
ii	
jj	
	- 32 - 

	B16C
kk	
ll	
mm	2* 
nn	
	End of col. and Foot

1\* Group with following.  
2\* Group with preceding.

B17C 18-22 (CT Temp 164)

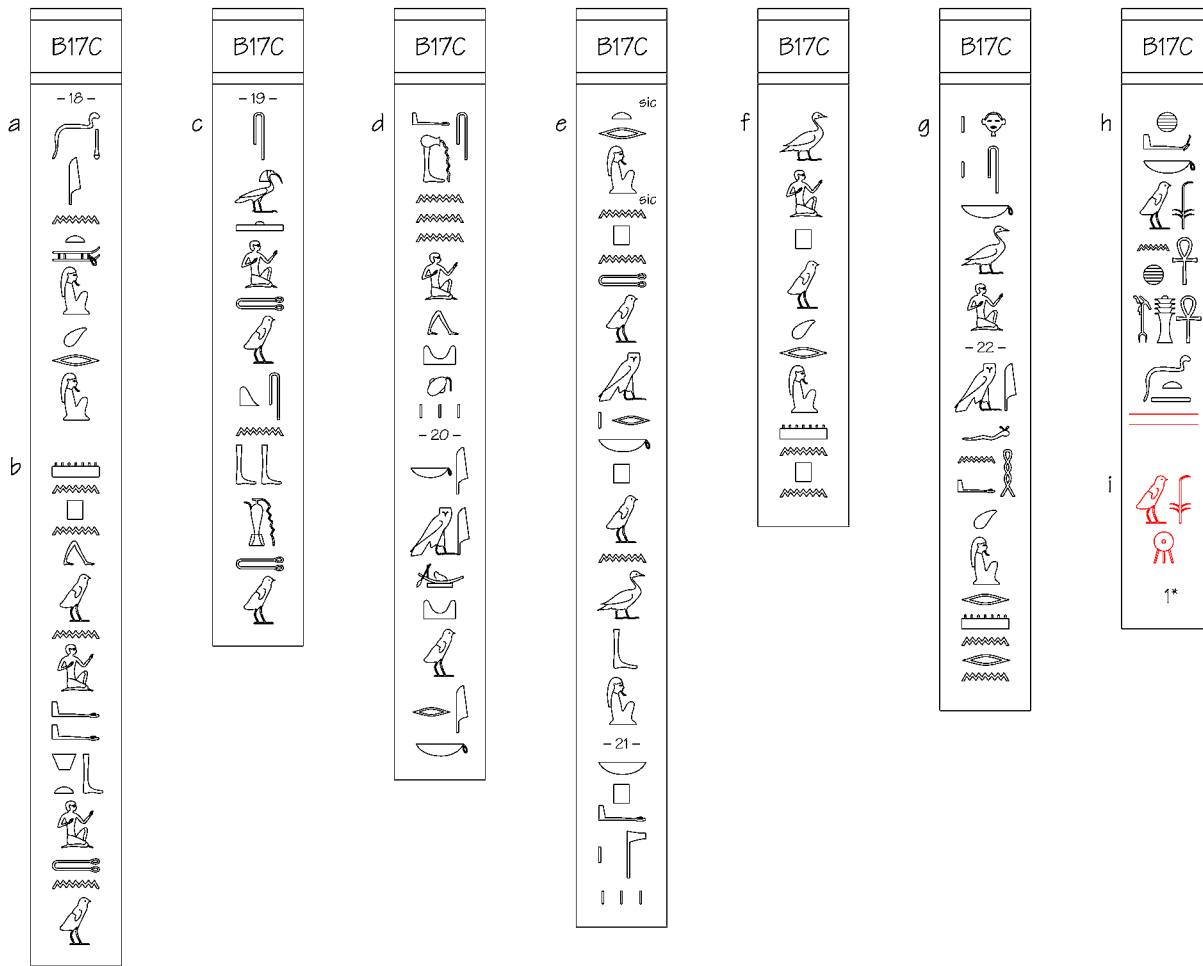

B17C 23-26 (CT Temp 378A)

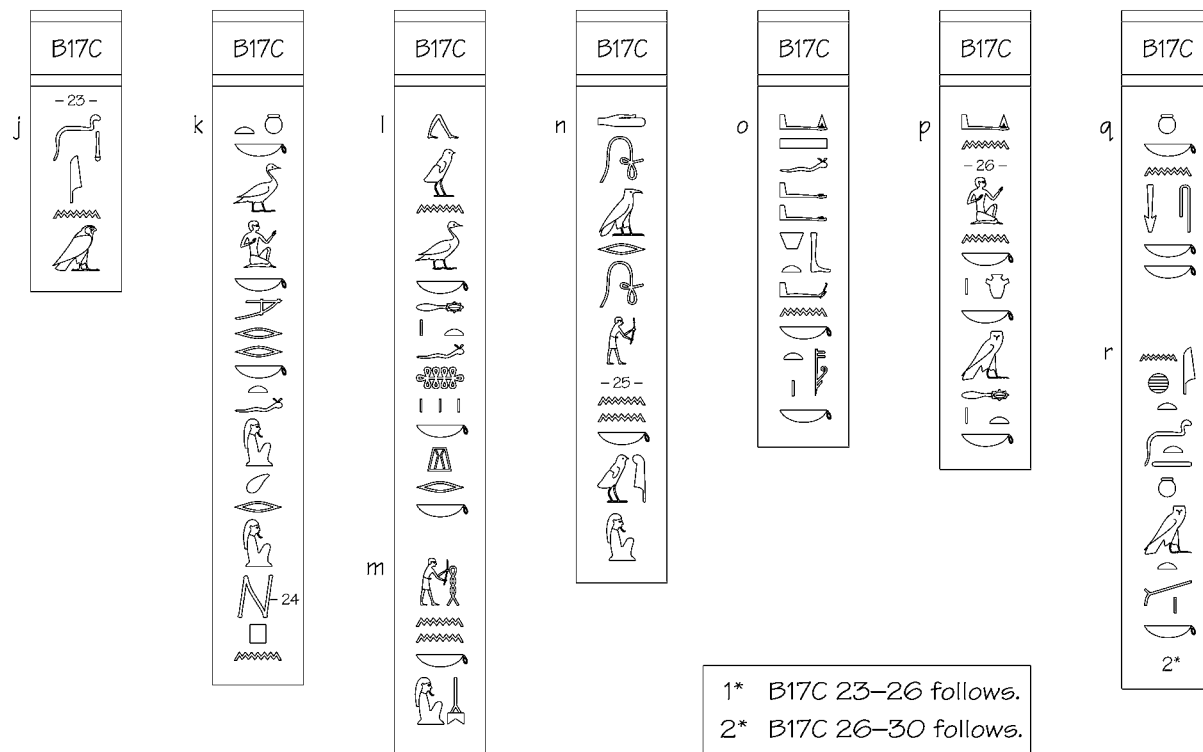

# B17C 26-30 (CT Temp 378B)

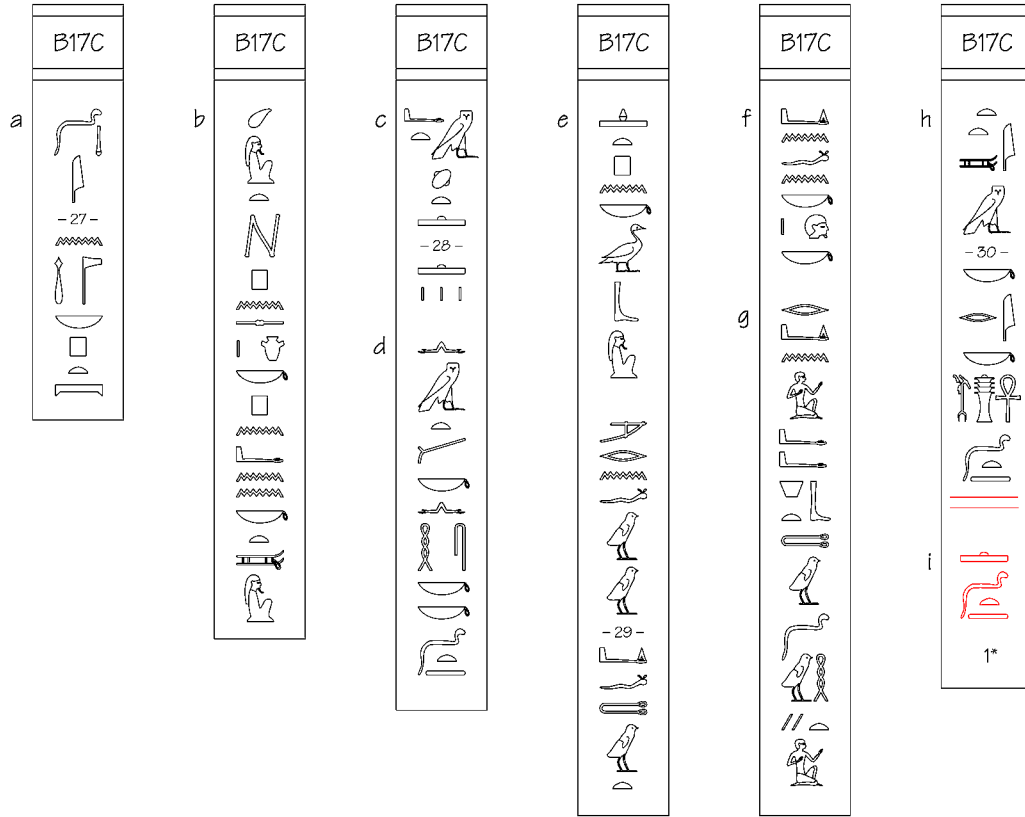

1\* B17C 31-34 follows.  
 2\* B17C 35-36+1-2 follows.

# B17C 31-34 (CT Temp 79)

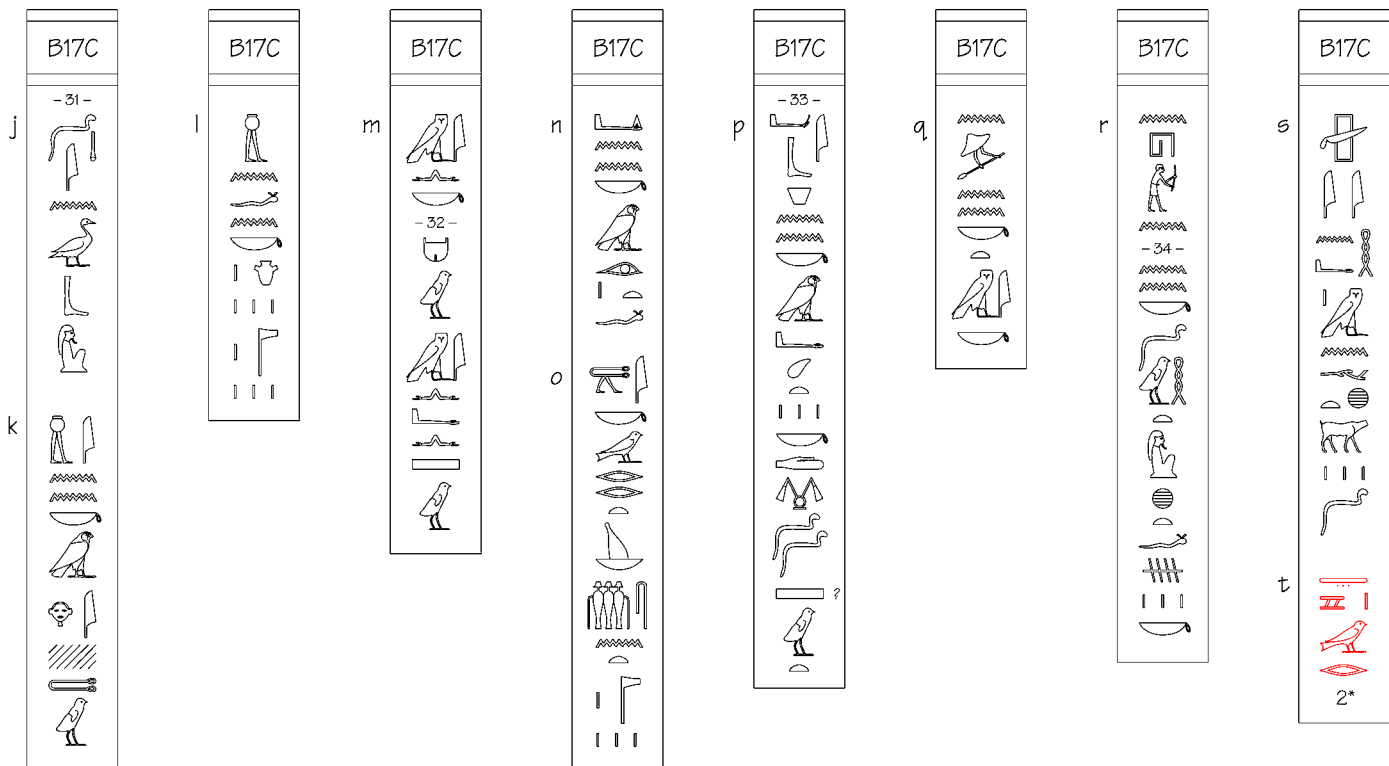

450

B17C 35-36+1-2 (CT Temp 166+276)\*

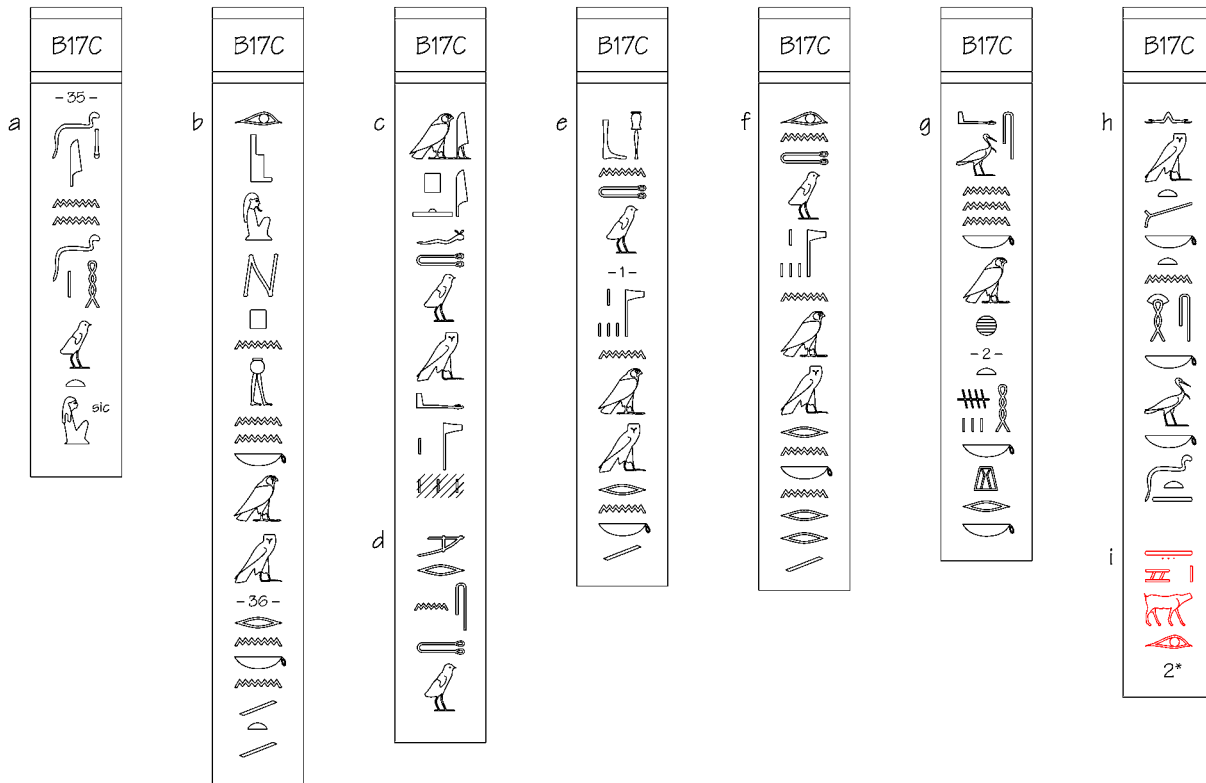

B17C 2-7 (CT Temp 228)<sup>3\*</sup>

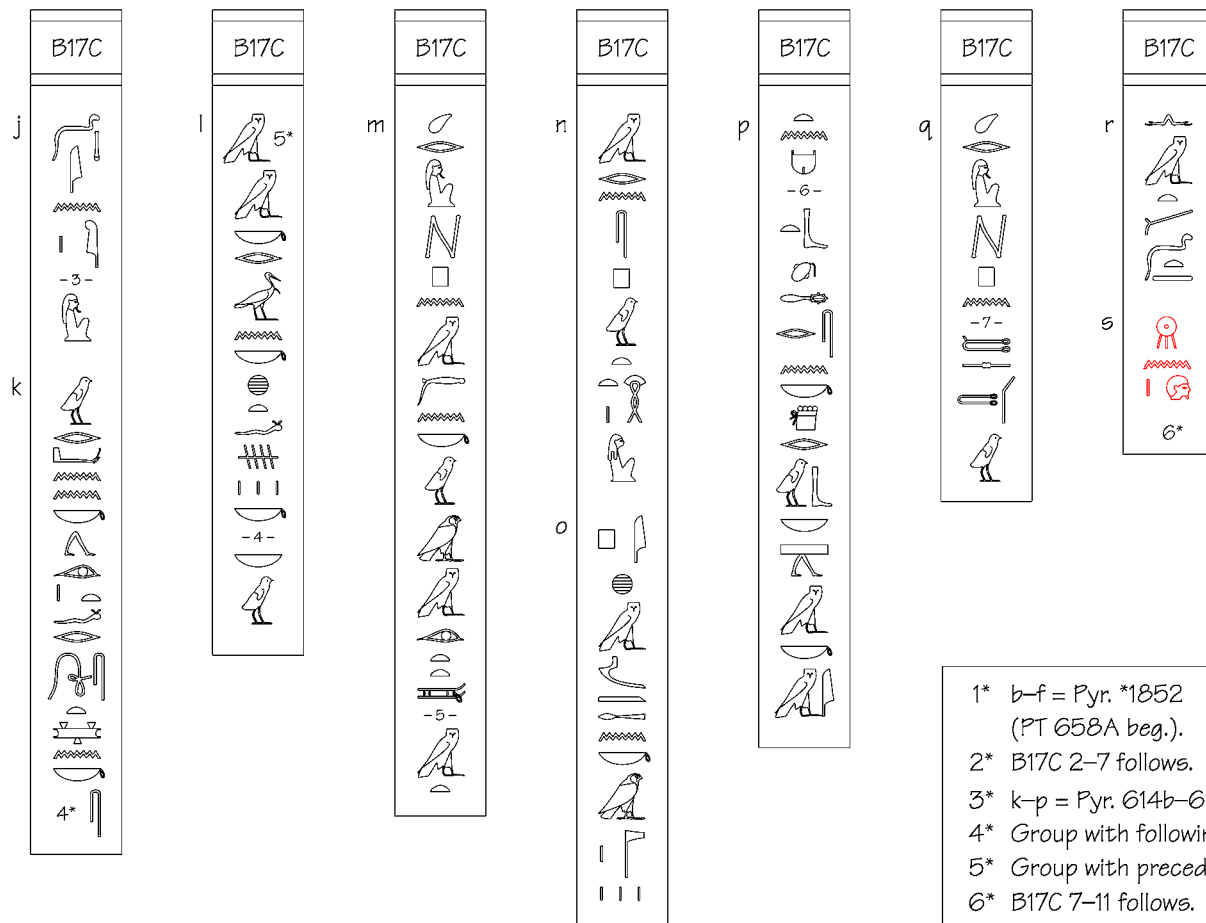

1\* b-f = Pyr. \*1852 (PT 658A beg.).  
 2\* B17C 2-7 follows.  
 3\* k-p = Pyr. 614b-615b.  
 4\* Group with following.  
 5\* Group with preceding.  
 6\* B17C 7-11 follows.

# B17C 7-11 (CT Temp 107)

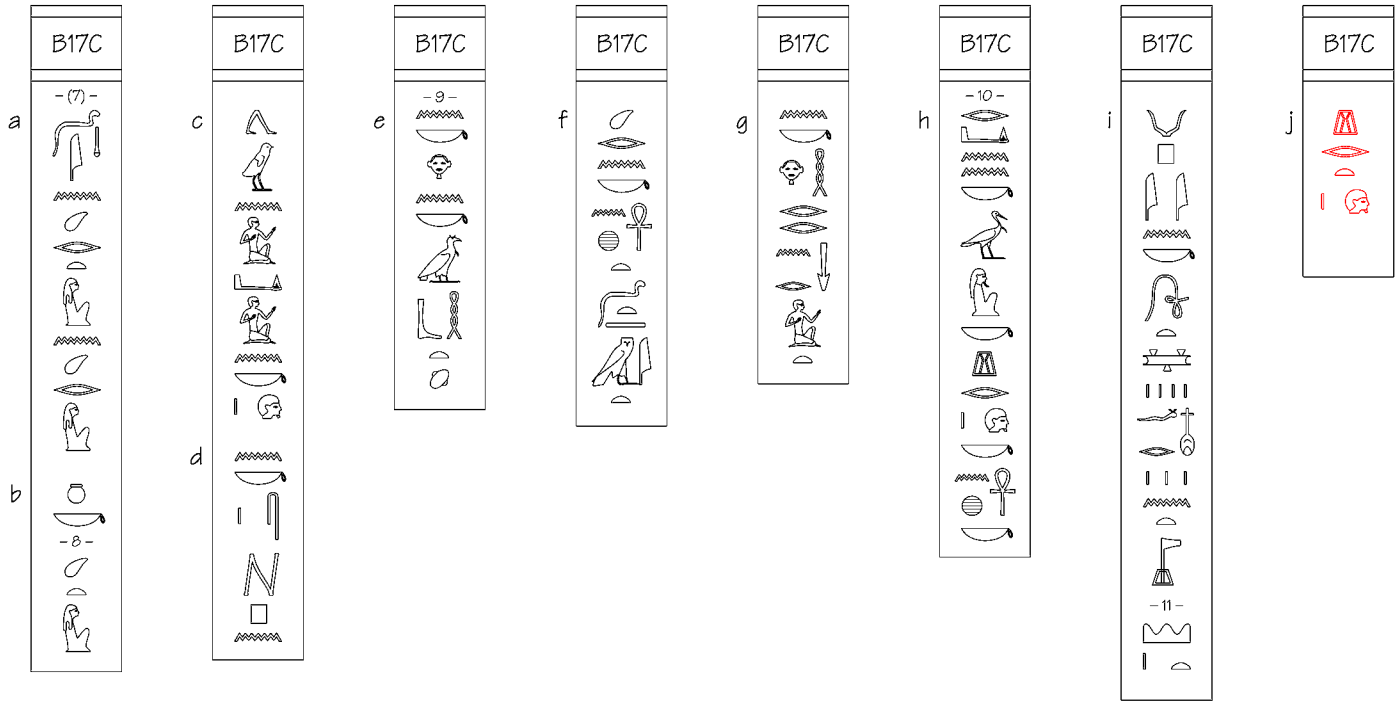

# B17C 11-15 (CT Temp 57)

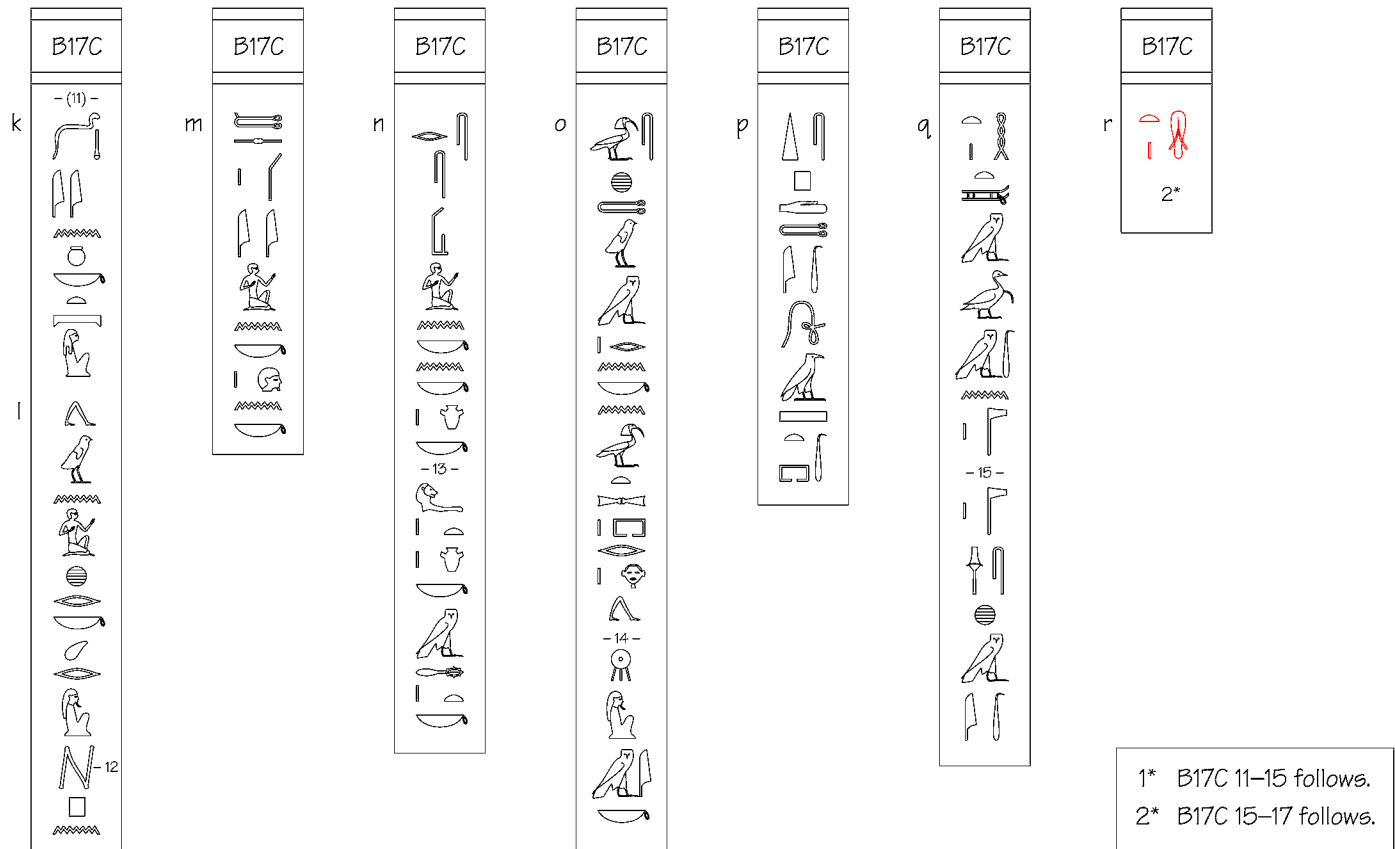

1\* B17C 11-15 follows.  
2\* B17C 15-17 follows.





# M7C 13-23\*

1\* These texts are similar to those of M7C 24-62 (pp. 441-43) and may be part of those lost in N 216+65-91.  
 2\* Perhaps PT 60 (N 289).  
 3\* 4\* 5\*   
 6\* Remainder of col. blank.

# S1C Ext. Back 5-10 (CT Temp 252)

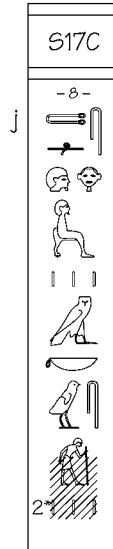
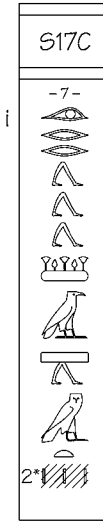
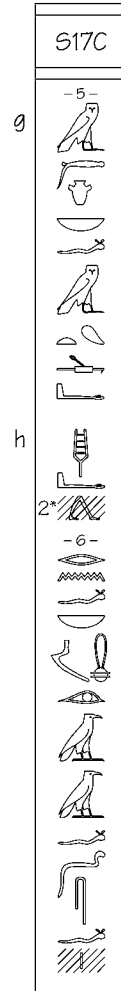
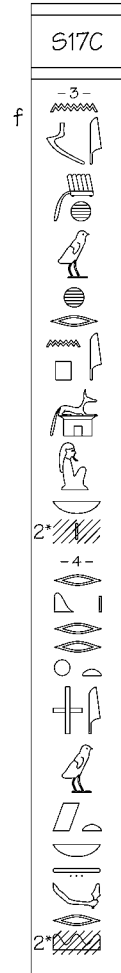
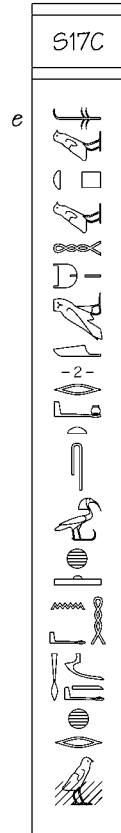
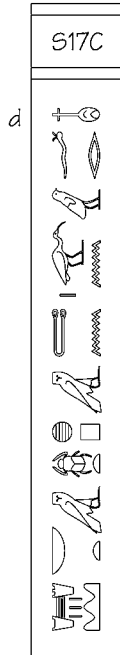
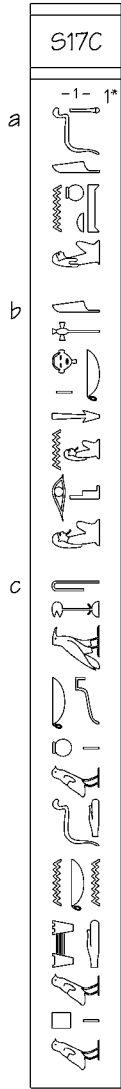

1\* Line 1 is the second line of the Front; the first, above it, is a *ḥtp-dj-nswt* text.  
 2\* Signs seen by Chassinat.



# T1L Edge Texts <sup>1\*</sup>

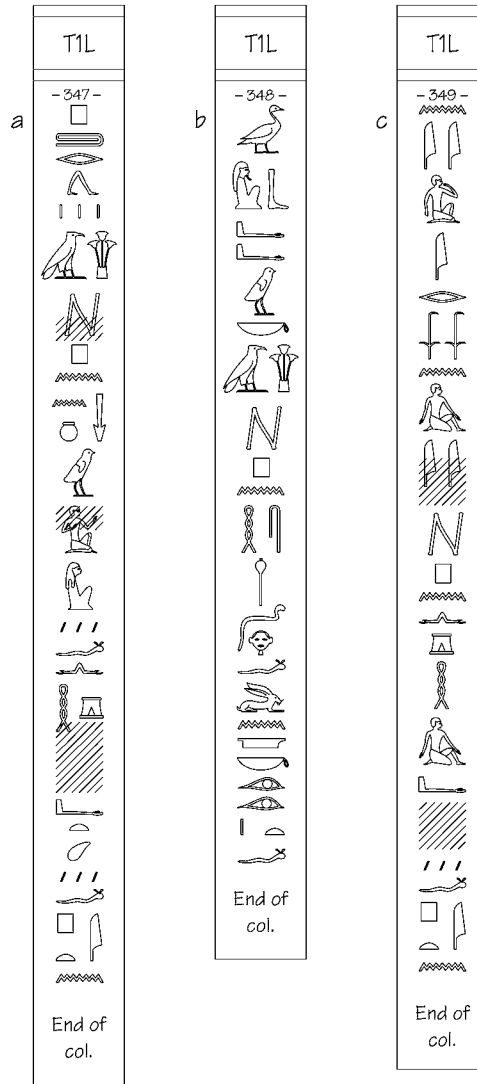

1\* Edges as follows:  
347 Head to Back  
348 Foot to Front  
349 Back to Foot.