

THE PSYCHIC SADIST

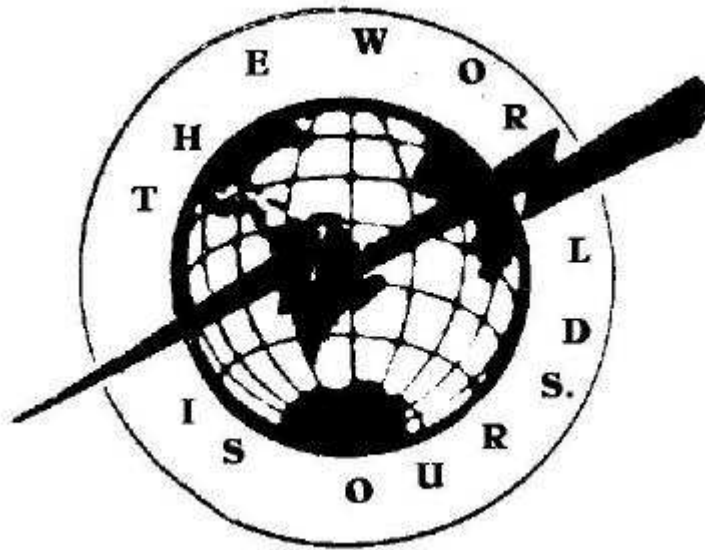

by

Charles W. Cosimano

copyright 2006

I

From the beginning:

Safety is for weenies; it isn't a good party unless somebody dies.

Now that we have that out of the way, this is going to be unlike any manual of kink that you have ever encountered. We do NOT, EVER, practice, advocate or have anything to do with that which is safe or sane and consent is strictly there to keep the lawyers happy. With psionics we can get around that. In fact, our goal is going to be:

The abolition of consent in our lifetime!

Ok, now that I have the hairs of those who do not know me or my work or background falling out, let me explain a few things about myself. For while this book may seem extra-ordinarily radical and revolutionary to those who come from either a conventional (ok, I know it's an oxymoron) BDSM background or the usual sweetness and light and don't do anything nasty to the neighbors psychic background. I'm not like that. I LIKE scaring the villagers. That is what villagers are for.

I have a couple of identities by which I am known. In the psionic/magick world I'm the great, wise and evil Uncle Chuckie, the purported father of modern psionics (I'm not! I just wrote the books.), general troublemaker and all-around no-goodnik. My Russian friends would probably love to dub me a *nekulturny khooligan*, but unfortunately I suffer from being over-cultured. Nevertheless, the khooligan part would probably fit. Or as my wife describes me, I'm just a big, overgrown 8-year-old. Anyway, if you're reading this book, you probably already know that. In fact you probably have read some of my other books and if you have not, be ashamed! Buy them now!

But I am also a "community leader" (Oh, Lucifer! I hate being described that way!) in the BDSM world. I was a club officer in the old Chicagoland Discussion Group for a number of years, starting as the, gasp, Librarian (it was a practical joke they were playing on me--they wanted to fill my house with bad porn) and then being promoted, by default because no other qualified person wanted the job, to club Secretary, a post that I held until that group's demise in 1998. And from there I went to being co-runner of the Chicago Slosh because my then girlfriend, who is now Mrs. Chuckie, made the mistake of saying that we would take it for a couple of months. More famous last words were never spoken, with the possible exception of the time my stepson was going to change our garbage disposal and said that it would take ten minutes. (Three hours later and by that time reduced to commenting on the sexual habits of monkeys...)

Somewhere along the line about the same time, some of our friends saw us playing at the old Leather Rose in Chicago and said, "It's the Dagger Dom." Well, I grabbed that as an AOL screen name and suddenly found that I, who had never used a scene name in my life, and did not believe in them, had a exactly that--Dagger. It was embarrassing, to say the least.

Oh well, it could have been worse. I could have been Guy Baldwin. (I'm going to have a lot of fun at the expense of Guy Baldwin because he something of a sacred cow in the SM world and as we all know sacred cows make the best hamburger.)

But also along the way it has become more and more obvious to me and those who know me that I have a much different approach to BDSM from my counterparts, not only in the way that I practice it technique-wise, but also as to how I relate to my BDSM interests as a part of my life, my work, and my world.

I'm not afraid of the things most of my friends are and there is a simple reason--
PSIONICS!

Ok, I know that I'm doing a lot of Me-I-Me here, but this is somewhat inevitable and the reason that I am writing this book is so that you, my most fortunate, blessed-of-heaven reader, will be able to do the same things and maybe see the world if not exactly in the same way, for no two people do, closely enough that you will find that your fears will have passed by the wayside and you will have methods of play and partnering that others around you will lack. For let us never forget, one of the purposes of life is to acquire things that other people cannot have. And NO, HIV does not count no matter what Guy Baldwin says! (And neither does bird flu so no kissing chickens.)

So this book is going to approach BDSM and Psionics as a series of life skills, tools of influence and power being aimed at making your sex life happier, healthier (for you at least) and at the same time allowing yourself the joy of breaking all the rules that folks in the BDSM community may try to put on you and keeping the godless nillers at bay.

Now, one other thing. This book is written from the standpoint of a Het, Male Dom. That is what I am and I don't write well trying to be something that I am not, nor do I have any wish to. And I have made a career out of breaking taboos, crossing lines and not only doing things that people do not approve of, but writing books teaching other people how to do them as well. As people who know me already know, I'm not one to sit around and complain. If there is something I do not like I do something about it and there has been something rotten in BDSM for some time now and that something is SSC! The words Safe, Sane and Consensual have become a millstone around our necks, an excuse for every damned do-gooder and would-be Pope in the scene to try to control people and ruin their fun.

Well, we've gotten rid of the Safe. We've gotten rid of the Sane. Now we are going to get rid of Consent! Psionics is a means of projecting power and when you project power you do not worry about the consent of the powerless. You do not have to.

At this point I should explain for my new readers that this not my first essay into combining these things. Ten years ago a literally deranged ex-girlfriend of mine wrote me a totally disjointed letter accusing me of, among many other things, psionically stalking her for the 18 years since our break-up. (And I still have that letter which someday I may put on a website so the world can see just how nuts people, and perhaps that particular person, can be.) Now, the irony of all this is that while I have

never hesitated to do anything nasty if it was going to be fun and I could get away with it, I had never even considered that particular bit of nastiness until she gave me the idea.

Anyway, I decided that I should have some fun at her expense and so when I wrote my *Psionic Terrorism* I put in a chapter on Psionic Stalking, or how to do astral rape for fun and profit. After all, if one is going to write about doing evil deeds, one should enjoy it and even though I had never really given any thought to it before, as I wrote the short chapter and had a good laugh at my own wickedness, I realized that there might be another use for these skills than I had considered heretofore.

It has turned out over the years that that chapter has become the favorite of the people who have read that book, even more than the chapter on how to blow up nuclear reactors which I thought would be the big selling point and actually was the real reason I wrote it because I knew it would drive foreign governments apeshit. (And it did! It was great fun!) So, without apology or moral justification, I present to you a volume on how to do everything people in the bdsm community tell you that you should not do.

Remember the words of H. P. Lovecraft:

"The time would be easy to know, for then mankind would have become as the Great Old Ones; free and wild and beyond good and evil, with laws and morals thrown aside and all men shouting and killing and reveling in joy. Then the liberated Old Ones would teach them new ways to shout and kill and revel and enjoy themselves, and all the earth would flame with a holocaust of ecstasy and freedom."

Have fun. Believe me, I have. But then I am the Dagger Dom.

I am--

Uncle Chuckie

Power and Transgression

The Transgressionist Manifesto

We are not old, obsolete guard, nor are we new guard. We are beyond such petty labels.

We follow no rules, save those it serves our purposes for the moment to do so, in accord with the practice of expediency.

We respect no authority and defer to no pretended hierarchy.

We despise tradition, that stinking collection of moldy walls and incontinent briefs that need changing. It has no place in our lives save as a source of never-ending ridicule and laughter.

We do not fear and we cannot be intimidated. We refuse to live in hiding, cowering like frightened animals.

We do not give a damn about community nor its image. We will never allow ourselves to be controlled by such considerations. Rather we defend the right of the individual to follow his own path and make his own decisions, to express his lifestyle by whatever definition he so chooses without regard to any external consideration.

We do not defend our lifestyle to the despised vanillas. We make them defend their lifestyle to us.

We admire skill, wit and daring.

We are the Outlaws.

We are the Anarchists

We are the Future.

We are transgressionists. We don't like rules, we break them. We don't like people who make rules. We break their heads. It's as simple as that. And we exist in a lifestyle that is beset with rule-makers and would-be pontiffs. This book is about ignoring their rules with absolute impunity and making life very difficult for the rule makers as well because while iconoclasts violate rules, transgressors violate people.

So let's get started.

Those of us who have the misfortune to spend too much time in the BDSM community, instead of getting real lives like normal pervs, hear the phrase "Power Exchange" a lot. And that phrase is utter hokum. Let us understand that power is never exchanged.

Power is seized and comes from the barrel of a gun. It is authority that is granted. At least that what happens in a common BDSM relationship. The submissive or the bottom, depending on the nature of the beast with two backs, grants the top/dom/master/supreme dickhead the authority to command her and do certain things to her body. That is were the consent business comes in. because the submissive/bottom/slave/dumb-bunny can always say "NO" to the whole thing. And that is always the case unless either the threat of force is present, in which case someone is probably going to need a good lawyer, or her mind has been so worked on that she is literally incapable of saying "no." And the track record for the latter is pretty bad because brain-washing wears off after a time.

Now, the usual cases of things like that, the situation is considered undesirable. We are going to approach it from a different way seeing things. We are going to operate under the idea that the deprivation of consent is the desirable state of affairs and as brute force simply does not work in our culture, and the more conventional methods of brainwashing will usually backfire, even after a number of years, we are going to learn to use our psychic abilities, backed by certain machines, to influence our chosen victims so that withholding consent is not only not possible, they have no idea that they would ever even WANT to withhold consent from us. Properly done, they will not even know the difference.

Not only that, we are going to learn to use the same techniques to impose our lifestyle and our desires on the world around us, whether the rest of the world wants it imposed or not. The principal of consent does not even begin to apply in such cases, in spite of the hair-splitting of our rule-making compatriots. We do not ask permission of cattle to eat them nor of sheep to shear them and the vanilla is of less value in the great scheme of things than either cattle or sheep. The outsider, the iskish and the gadje, are literally fair game. After all, you can eat cattle and sheep.

And to illustrate this let me tell you one of my favorite stories.

Almost 20 years ago now (time does fly when you are having fun!) I was in a grocery store with a young girlfriend and we found ourselves in the hardware section. She took one look at the plastic bag closing clamps and shouted "Nipple clamps!" at the top of her lungs. (Which was only logical as that was what we used them for.) There was a little old lady at the other end of the aisle and she almost went to her ancestors from shock. It was absolutely hilarious and it would have been even funnier if she had actually dropped dead!

Oh well, can't have everything, damn it! After all, it isn't a good shopping trip if nobody dies.

We are going to transgress the norms that say we should not have such fun.

So let me give you a common example.

Take the above story and change the little old lady to a mother with ten children ranging in age from 1 to 5 in tow (she took those damned fertility pills and now is truly cursed of Shub Niggurath, the Black Goat With a Thousand Young). She hears the shout and has to try to explain to her five-year-old what nipple clamps are (if she knows) and is really uncomfortable about that. Now, our do-gooder folk would deny us the joy of that woman's discomfort. I mean, can you just hear them? "What about the poor mother? What would she tell her children?"

Oh boo hoo hoo! Like we give a damn!

Put a sock in it!

Let us be honest. It was her own fault! No one made her have the little bastards and so any discomfort she may have to deal with because of it is no one else's problem but hers. Certainly not ours, we owe her nothing but a quick death, unless we think it would be fun to cause her to have a slow and lingering one. And besides, it would be fun watching her grab her brood and run out the door in panic!

We'd still be laughing! Ok, not laughing as hard as we did at the dom who looks like an Amish cowboy, but still pretty hard. (Do these people own mirrors?)

To put it bluntly, the stupid bitch came in the door with a big "Kick Me!" sign taped to her back. So to make all this simple and give you the philosophical basis of this aspect of the work, there is no obligation to strangers. None whatever. They exist for only one purpose and that purpose is to provide us with fun at their expense. The notion that we should refrain from an action because it might cause some emotional discomfort to someone we do not know, do not care about and have no financial or other reason to keep happy is nonsense in the extreme. "If the gesture is beautiful, the victims do not matter." And that is because it is the victims that make the gesture beautiful.

Ok, are you getting our approach here. We are Hedonic Sadists. We believe that it is fun to torture people and that can include all manner of methods that do not require a playroom. And those methods do not require the consent of the victim. In fact it is intended that they should not. As long as there is no physical contact, and it does not take place in the workplace (and with psionics even that proviso does not apply), there is no legitimate recourse on their part and if they are stupid enough to think that they have, well they have nasty surprises coming. They are cattle to be devoured. And we will devour their souls in due course.

Transgression is fun. It is also liberating. And when transgression is combined with psionics... Well, you get the picture.

The psionic paradigm meets BDSM.

Psionics is a tool for the projection of power.

This is where the power aspect comes in. Power is the capacity to get things done, in this case, to impose our will upon people without their consent. It also enables us to get away with what we do in ways that our fellow pervs cannot imagine. Because, you must understand, (and my regular readers already know this) psionics is a mighty weapon in the wrong hands and the thrust of my work has been to make sure that it falls into the wrong hands. (After all, you can't get wronger hands than mine, tee hee hee.)

Now, those of you who know the sort of stuff I work with, know that I approach the subject of psionics with a singular ruthlessness which sometimes frightens even my most ardent fans. That is fun. I love it when one of them says, "I don't agree with everything he does but..." It is simply a matter of recognizing the capacity of the psionics to project power, in many cases destructive and lethal power and the willingness to use it.

This sort of spills over in everyday life on occasion, if I haven't had enough sleep or I'm in a bad mood and then, for some reason, people get rather nervous about me. I remember one night at the local dungeon when I was talking about psionics and the young woman that I was talking to asked me what it did. Well, I was in a rather testy mood that night and I growled, "It kills people."

And then there was time when someone said something about somebody wanting to close down dungeons and I said, "Get me his photograph, he'll be dead in a week." For some reason, people's hair stood on end when I said that. There is a reason why I don't waste much time worrying about law enforcement and by the time you are versed in this material you won't worry much either.

At that point people's eyelids start to raise and they sort of wonder if I'm all there and maybe there is another reason for my rejection of the "sane" part of SSC. But that's ok too because being a bit crazy is a useful skill, as long as you don't do everything the voices tell you, except of course the one that told you to buy my books. In fact you can probably hear them saying that to you now.

Buy Chuck's books.
Buy Chuck's books.
Buy Chuck's books.

But seriously, if you have the capacity to remove anyone who is going to get in the way of your fun, why not do so? After all, no law can stop you from using your mind and the equipment I am going to explain in this book is so damned simple that no government can hope to regulate it. And if they try, well, we have the means to foil them even if they wear foil on their heads. And that ability, combined with the ability to override the will of another, is a mighty force. And there is more.

With psionics you can really twist someone's head. You can dominate a person--sexually--without even being in the same country and having no contact with the person other than your mind and maybe a simple instrument.

So now you can forget all that nonsense about consent. Consent is for sissies! Psionics is, after all, about the elimination of consent. When we do our psionic work in other areas of life we do not ask the consent of the target. When we do our research we cannot ask consent of the test subject because that would screw up the data. So those of us into psionics have never really cared about consent to begin with.

Oh, and occasionally someone who lacks a knowledge of history will babble something about nasty things coming back to you for doing this. Ignore such people as they are only trying to make you behave in a way that they want rather than in a way that you want. The nastiest people in history tended to die of old age and usually quite wealthy.

There is one more objection that you will hear to this philosophy and that is the notion that by eliminating consent we make ourselves vulnerable to those who would try to destroy our little hobby. What those who use that argument do not realize that by thinking that we should censor ourselves they actually would make us vulnerable to the very people they are trying placate.

Why is this? It is very simple. They are arguing from a position of assumed weakness.

What is happening every time they say such things is they are saying to the enemy that we are weak enough to worry about what other people think. That is precisely the wrong approach to take, especially with psionics at our disposal.

The proper approach in dealing with the enemy is to say, "We are people who torture people for the fun of it. Are we really the kind of people that you want mad at you?"

Add to that the weapon potential of psionics and we silently can ask them another question, "Are you feeling lucky, Pig?" Because with psionics we can reach out and touch, or rather smite, someone with no possibility of being discovered or stopped. We can act with total impunity. In other words the presence of another person's face does not in any way affect our right to swing the frying pan. Their face only changes the fan's trajectory when it hits it.

So in answer to the argument of weakness we can respond with honesty that we really do not care. We do not have to. It is simply a matter of changing the paradigm from the craven, cowardly, oh-so-law-abiding, NCSF one of "We are so weak and helpless we must always live in fear of the rest of the world and maybe if we are really nice and play by their rules and be good little house Negroes and then maybe if we're really good they won't persecute us," to the psionic one of "We can do anything we want and remove anyone who would try to stop us. It is we, not they, who are the Masters of the World."

And remember, freedom is doing what you want, not what others think you ought. And Lord Acton can shove it up his ass! (Extra points if you figure out the reference.)

But enough of such rumination.

To work!

Basic Psionics--The Energy Field

Those of you who have read my other books can pretty much skip this chapter except for the fun stuff.

Psionics is a branch of psychic work. It utilizes the usual means of meditation, visualization, concentration, etc. but it also involves certain devices, ranging from a simple pendulum, to charts, small radio transmitters, light sources such as a flashlight or six-volt lantern and even more specific devices such as the psionic amplifying helmet, and, of course, radionics. It is an area of study that drives people nuts when they first hear of it and it makes people who do not believe in it think that we are nuts.

They're right. We are nuts, but at least we have fun being crazy.

But it all comes down to one thing--the human energy field and its study and manipulation, because if you can do that you can know everything the other person knows and you can make her do just about anything you want. It is simply a matter of time, patience and work. And no one is safe. When you use this stuff you are subject to no rules, no laws, nothing. There is total freedom and absolutely no responsibility.

You are accountable to no one. When you work with this you can do anything that you want to anyone that you want.

So let us get started with the human energy field. This field can be broken down in any number of ways and I go into that in much more detail in my other books, but for the purpose of this work, we can divide it into two basic parts, the electromagnetic field, commonly referred to as the aura, and the non-physical, or etheric field. These fields inter-relate with each other and the information they carry is transferred back and forth between them. This is important to understand because this explains why psychic information gets into the physical brain and manifests as electro-chemical impulses when by all rights it should not do anything at all.

It also explains why the electrical activity of the brain can influence a brain at any given distance in spite of the inverse-square rule which would remove any possibility of that influence being electromagnetic in origin.

In any event, it is as good an explanation as any and I'm the person writing the book, so that is the one we will use. So there!

But the important point is that the etheric field can interact with any other person's etheric field anywhere on the planet. There is no escape! No matter how far the person may run, no matter how well she can hide, your mind can seek her out and find her. Where she to hide in the depths of Hell you could still find her.

Now, you have to understand that that does not mean that you will get results immediately. Some times you will and sometimes you will not. In my own case I occasionally have had to wait years for results, largely from not doing my homework.

Let me give an example. Over 20 years ago I fell madly in lust with a young woman who worked in the local library but I am a very shy person. I know that this surprises people but I really really really am! I could not figure out how to approach her. But I am also a very good psionic operator and I figured I would solve the problem in the most simple way. I would make her approach me!

Simple, right? Well, in theory it was.

In practice, it was a disaster at first. I did all my mumbo-jumbo, with machines and thoughtforms (I'll explain all that stuff soon) and nothing. Nada! Why? Well, It wasn't because Mumbo and Jumbo were making pancakes for Sambo, that's for sure! (Yes, I know that I'm being naughty.) It was because I did not know that at precisely that moment in time she had gotten herself engaged to be married!

Talk about stupid dom tricks!

So after a time I abandoned the project and figured that it was one of those that just did not work for some reason. And yes, that can happen. And I proceeded to get on with my life and tie up every woman I could get my paws on and thought nothing of it again.

But the project kept working even without me.

Eight years later, I was in the library waiting for the tow truck to come and get my car which had broken down in the Jewel parking lot across the way. And as I was thumbing through the card catalogue (something they used to keep track of books with in the ancient days before everyone had computers) she came up and we started talking for the first time.

A year later we were together for a time.

What had happened was that her marriage started to fall apart and as soon as that happened the project, which I had long abandoned, had kicked in and she was drawn to me just as she was supposed to be.

What had been a dreadful failure became a marvelous, if temporary, success. (It turned out that we were not really compatible, but it was fun while it lasted.)

Over the years I have learned that projects rarely fail, they just have not worked yet. Sometimes they do, but the success rate is far higher than the failure rate.

And with that out of the way, back to the energy field.

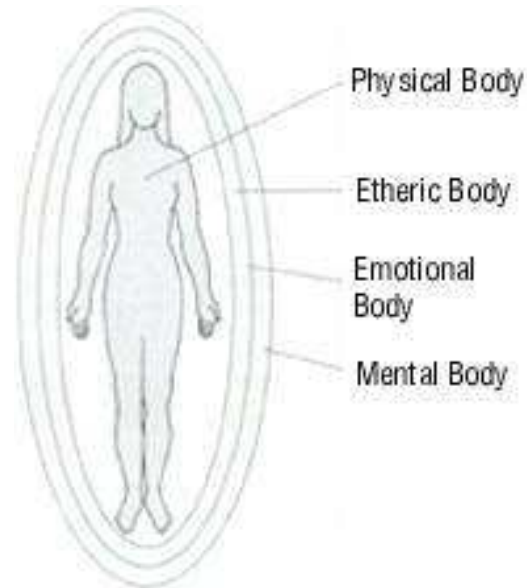

This illustration shows the usual breakdown of the field and it is the way I present it in my other books. But, like I said, we do not need to be that detailed in this work. I put it in to give you a basic notion of what we work with.

Now, a two-dimensional drawing has certain weaknesses, like not being able to show how the field totally interpenetrates the person and everything else out there. Think of the thing as a sphere of sorts that just keeps expanding ad infinitum, sort of like spam. It goes everywhere, goes through everything and just does not stop, kind of like an email rumor or some of the old wife's tales we hear of in bdsm (for details on those, see Castle Realm). This is to our advantage because it means we have no range limitations. We can hit any target, anywhere in the world.

So how do we make use of this field?

The same way we get to Carnegie Hall--practice, practice, practice.

We begin by sitting. That's right, just sitting. That is an easy thing for bottoms, they are used to not moving. We find ways of keeping them from moving. For us tops however, it is a little more difficult. But find yourself a chair that is comfortable, but not too comfortable. You do not want to fall asleep so the recliner is probably not the best one to use for this.

Once you have your chair picked out, sit like an Egyptian. Ok, I know it's a bad joke, but they can't all be gems.



Just sit, spine erect, feet flat on the floor or on a stool if you are really short, hands resting on the chair arms or your thighs and think of the Days of Sneferu when the poor Pharaoh had to resist saying "Osiris bless you," every time someone said his name. (And the first person to say, "Like sands through the pyramid....," is going to be fed to the crocodiles!)

Now, feel the energy field around you and in you. This will take a bit of trying because it rarely comes right away, but with some effort you will begin to feel the energy flow around you. As you do this, know that you can manipulate, shape and expand this energy as you desire and it will carry information that you will place into it. By means of this energy you can reach out and touch anyone in the whole world, you do not need their consent, they cannot deny you, in fact most of the time they will have no idea at all where the funny feelings between their legs are coming from. And as you know this you will know that the very notion of consent is foolishness in this context. You are beyond such petty considerations.

Set aside some time every day to work on this. It does not have to be a great deal of time, about ten minutes a day to start with. As you go along, you will find that you enjoy this so much that you may totally lose track of time and realize that you have been sitting for an hour or more without even thinking about it.

Once you have mastered this exercise, it is time to start charging your field. This is to boost its power. To do this we use a very basic and old-fashioned method. We bring energy into you by visualizing it as a cosmic light source.

Gaaack!!

I know that sounds trite and disgusting and worse, New Age, but hell, it works so here we go.

Sit and visualize a light source over your head. If you are lazy, like me, put your chair under a ceiling light and then you have the light source ready made.

Ok, once you have the notion that you are being bathed in the cosmic, all-powerful, Divine Light of the Universe (Stop laughing! This is serious important psychic stuff!), feel it penetrate your entire body, filling you like an empty bottle with concentrated power. Keep pumping this light in until you feel like you are going to explode and then when that point is reached, release it back into the universe with a mighty cry of:

In the Name of Uncle Chuckie, DIE Guy Baldwin DIE!!!!

Ok, I'm having fun. Just let it go rushing back out into the cosmos because otherwise it tends to cause headaches. Not that there is anything wrong with causing headaches, mind you, but you want to cause them in other people, not yourself.



Practice this for about a week or two until you end up looking like the above illustration and then move on to charging the chakras.

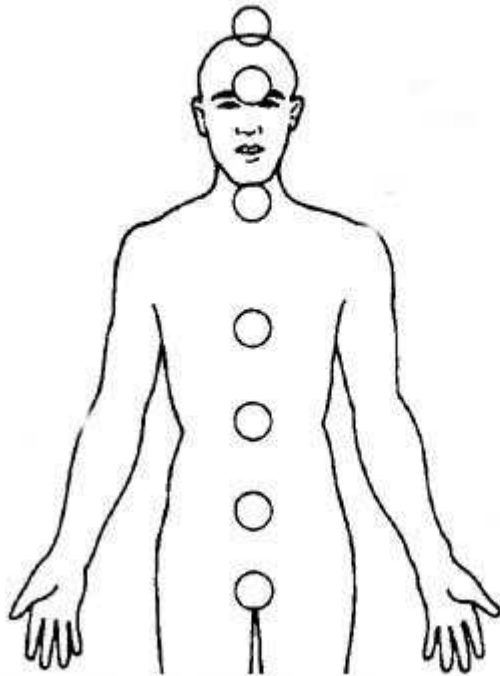

Now, if you look at this drawing, you will notice a number of circles, seven in all. This is the usual presentation of the chakra system but there are variants.

At the top you find the Crown Chakra. This is the one that powers the whole system and organizes it.

At the base is the root chakra, which is where energy is stored in the Kundalini system but is also the location of sexual energy that feeds into the pelvic chakra which is pretty much in the same place. Guess which one we are going to be working with.

The others do not matter very much for our purposes. The spleen chakra distributes the vital force that keeps you going and we are not doing healing so you can pretty much forget that one for the moment. The one at the tummy, on the other hand, controls gut feelings, for some peculiar reason, and so if you want a strong, visceral reaction you aim at that one.

The heart chakra is for more rarified emotions, we don't deal much with them. After all, this book is about sex, not about love.

The throat one controls involuntary muscle response and is a good receptor of thought energy. You can give a person serious willies by staring at it from behind them.

The brow chakra is the one that you use to emit thought energy, it's sort of like a spotlight on the center of your forehead and when you are wearing a spotlight on your forehead the light from it makes a great carrier wave but more about that later.

Ok, got all that? Obviously things get a lot more complicated and as we go along we will work with a little more detail, but that is what you need to get started.

So now it is time to do the light exercise over again, only this time do it to get the chakras running at full blast.

Begin with bringing the light into yourself as you have been doing. Once you have got yourself packed with light, focus it into the base chakra and charge it up like hell. Get it running good and hot, and then when you have that warm, glowing feeling, send it rising up your spine to the spleen chakra.

Let that run for a while, feeling that your vital energies are being recharged and your cold is going away, then send it up to the Solar Plexus.

Hold the energy there, giving strength to your emotions and your ability to project them, then raise the energy to your heart.

Let that spin there for a while and then bring the energy up to your throat.

Again, hold the energy for a while before raising it to your brow.

At the brow, feel the spotlight being turned on and shining a beam all around the room. Know that you can charge that beam to send any message, feeling or response to anyone anywhere in the world, whether they want it sent or not!

Now bring the energy back up to the top of your head, to the crown chakra, and let it go blasting back out into infinity.

Once you have got the hang of that, repeat the exercise daily but do it as a circle, the energy being focused into the root, or base, chakra and then rising back up the system, out the top of the head and back to the root chakra, as a continuous circuit keeping you constantly charged and constantly able to act.

One of the side effects of this exercise is that your energy field is going to get a lot more powerful and able to do things you would not expect it to do. And very often it will do things when you do not expect it do them, like occasionally screw up electronics and blow out street lights. These are normally minor annoyances, but do not be shocked when they happen. It is all quite natural.

You may also find that people around you react differently to you. Depending on the person, they may be more attracted to you, or they may not be able to run out of the room fast enough. That is because your field is interacting with theirs and they are responding to it, quite unconsciously.

So now it is time to work with this thing, to play with it and have some fun.

Practice the above until you are able to do it very quickly, like in a couple of seconds. I know that may sound difficult but it is actually very easy and you should have little trouble in doing that. There is a reason for learning this and that reason is that you will want to be able to do it on a moment's notice. After all, you never know when the opportunity to have some good, nasty fun will emerge.

When you have the skill down, go out among the masses, like you do every day, only this time go out like Count Svareff, looking for victims. (Count Svareff is the bad guy in one of my favorite movies, *The Most Dangerous Game*.) You are now the predator and everyone else is the prey, but this time you are not going to do anything particularly dramatic. You are just going to have some fun.

Have you ever noticed that sidewalks are really poorly engineered. They go right up to the street, with a curb a few inches high that can be a real menace if someone isn't looking. Well, if you have the good fortune to be on a crowded street, there is always going to be someone who is walking a bit too close to the curb for his own good.

Of course that is not too close for us to get a good laugh at his expense.

When you see such a person, charge up real quick and then will your field to expand extremely fast, pushing at the field of the person walking close to the curb.

Surprise!

For some reason the person is just sort of pushed off the sidewalk into the street, where he is barely missed by a passing bus! (Of course if you get really lucky he is not missed--splat!)

Tee hee hee!

Now, let me explain what just happened. The person was not pushed in the exact physical sense. In other words, he was not shoved by an unseen force as if you had walked up behind him and used your hands. What happened was that your field hit his field and his field reacted, making him move away from you without thinking about where he was going. And where he was going was face first into the street and under the bus.

Now, did that poor fool give you his consent to be pushed off the curb? Of course not. And was what you did safe or sane? Don't be ridiculous. Was it fun? Sure was!

Ok, it was not as much fun as pouring gasoline over a bag lady and setting fire to her, but what the hell, with this you don't have to worry about being caught and having to deal with the paperwork, as well as killing the prosecutor etc... I'M KIDDING! (You concentrate on the fire element in her etheric body and she has spontaneous derelict combustion from the cheap alcohol oozing out of her pores. Much less paperwork, but I digress.)

Do you get the idea that we are expanding the idea of sadism out of the dungeon? Yes, that is exactly what we are doing.

We are getting honest!

You see the problem with BDSM folk is that they have become fundamentally dishonest about who and what they are. They hide behind slogans such as "Safe, Sane and Consensual," or "Risk Aware Consensual Kink" (Do you see all the consent crap in those two?). And in doing so they have brainwashed themselves into thinking that they are just like everyone else with just a weird hobby. They have never been able to accept themselves for what they are and they need to engage in orgies of self-justification and convince themselves that they really are "normal," instead of being the happy, godless perverts that they are.

Well that is not what we are. We are people who take great pleasure in causing pain to other humans. In a different context, what we do for fun on any given Saturday night would be considered war crimes! Not only are we not like other people, we are better than they are.

We have the capacity to enjoy and feed off the sufferings of others and there is no reason, other than the paperwork, that we should confine that joy to a dungeon on Saturday night. There is just too much evil fun to be had.

Back to work!

Let's have some more fun with the field. This time let's have lunch in a crowded restaurant.

Normally I don't like to pick on waitresses. They tend to be a combination of cute and overworked and the pay sucks and people don't tip or tip too little, especially our fellow pervs who are the cheapest people on Satan's green earth. But every once in a while it is good to be nasty for its own sake and there is something about a waitress balancing a tray full of food that just seems to cry out for it.

I discovered this by accident many years ago. I had just driven home for a weekend from school and my parental units were taking me out to dinner. They picked a restaurant that was a bit too popular and we were stuck sitting waiting for a table. I was not pleased. Anyone who knows me knows that I am not a good person to be around when I am hungry. I tend to get very vile tempered and take bites out of the people sitting next to me. However, the gods smiled upon me that night and took pity upon my frustration. A waitress was carrying a tray of food, and it was a well loaded tray, and somehow it went off balance, causing the food to come cascading down upon some poor diner. Dinner was truly on him that night and I cheered up immediately.

Do you see where this is going?

You have a crowded restaurant, with little room to maneuver, people carrying food all over the place and other people stuck sitting in the line of fire. The Hand of God is in this!

Wait for the right moment. You will want your target to be carrying a tray with a number of orders piled onto it, the more the better and the secondary target to be the elderly woman in the booth a bit up and across from the aisle from you. I really like to pick on old people because they are esthetically displeasing and very slow and annoying. I can't count the number of times I've found myself behind some damned senior citizen in a walker and wishing that I had my cattle prod. I'd get the old bitch moving!

Anyway, wait until all the stars are aligned and then fire up your field and expand it at the waitress!

KERSPLAT!

Watch the destruction as your field hits the field of the waitress and she just sort of jerks away from it, causing the tray to go off balance and the food to come crashing down on the old folks who should be at home anyway. Cover your mouth to hide the giggles (insane cackles are appropriate but only as you are driving home) and watch the fun as the staff all run to make sure the old farts are not injured and dispense apologies along with gift certificates.

DEATH TO ALL PRE-BOOMERS !

(By the way, if you want to have fun with old people in a restaurant, beat the cadence played at John Kennedy's funeral on the table. If you don't know it, there are videos of the funeral procession online. They won't remember where they heard it but it will give them the willies. It's a fun prank and works on anyone over 60.)

Now that was fun, wasn't it?

And what makes it even more fun is the knowledge that there are people who do not approve but there is not a blessed thing that they can do about it. That is one of the keys to dominance--the ability to ignore the disapproval of others.

As I always say, "Real Doms don't care what other people think."

Ok, enough of such merriment for the moment. Back to work.

Now that you are used to working with your field, it is time to concentrate on working with the specific chakras. I've gone into more detail about them in a couple of my other works, notably Psionic Power, but here we will look at a few of them and how they can be used for pervery, in particular the root chakra, the solar plexus chakra, and the brow chakra.

Let's start with the root chakra (actually it is the pelvic chakra we are dealing with but they are so close together that I'm going to stick with the conventional system for once so you do not get confused more than necessary). The energy of the root/pelvis system is what runs sexual desire and function, so obviously this is one you are going to use, a lot!

You can both transmit and receive with any chakra and in your case, being the one who is acting rather than the one who is acted upon, you will be using the root chakra to charge up your field with sexual energy and transmit that energy to the your chosen victims, whether they want it or not. And you will find that it is very simple to do that.

Well, it is very simple once you master a little skill called visualization.

Visualization is a function of the imagination and it is the imagination that powers this stuff. What you basically do is imagine that you are seeing something and if you do that well enough you can really see it.

So you have to work on your imagination. This is going to take some time, so be patient and remember that Rome did not burn in a day.

Begin by just sitting with your eyes closed and looking at images in your mind. Keep these images as simple as possible, a circle, a line, that sort of thing. With a little practice you will find that you can hold the image for a time, but it will sort of flash in and out at first so do not be disturbed by that.

Work on this for a couple of weeks. And while you are doing that, keep up the charging exercise.

When you are able to hold the image in your mind for a few minutes, it is time to go onto the next stage, seeing it in space with your eyes open.

Ok, this can be a toughie. I developed one of the techniques I will describe later because I could not do that for shit when I was young. But keep at it. You will find that it is one of the most valuable skills you can have.

Put a blank piece of paper in front of you and look at it. Do not try to stare, you will only give yourself a headache. Now, see a chosen image, such as a circle, on the paper. What you will probably get is a sort of shadowy, floating thing hovering just above the paper. But that is perfect. It means that you have acquired the ability to take an image from your mind and externalize it. And that image is able to do work.

What you have done is create a thoughtform. Now this particular thoughtform does not do anything but float over the paper, but if you wanted to, you could program it to cause someone to do something they would not normally want to do, like hop into bed with you.

We'll get to thoughtforms in a little bit.

Now back to the root chakra!

To work with this chakra, you need to have a victim in mind. It does little good to charge it up and get it running with no target. So your first task is to pick a target, preferably someone you know and find attractive but who has not shown great interest in you. I know all about this because with my face the hardest thing was to first keep the woman in question from falling down laughing. I've been accused of many things in life but being attractive is not one of them. Large, angry dogs have been known to run away from me.

I hope you are not similarly blessed, but if you are, this will fix it. Your face will not change, but her reaction to it will.

Begin the procedure with some practice. You know how to charge your field and you know you can visualize. Now combine them to charge up the root chakra.

Close your eyes and see the energy coming into you as when charging your field, only in this case see it as collecting in the root chakra and really charging it up. The chakras are traditionally represented as wheels (which is the literal meaning of the work in Sanskrit) and you will see the root chakra as a red wheel, spinning madly out of control.

Hold this image and now make a little shift in the image. Transform the wheel into the round lens of a spotlight and see it shoot a red beam, like a laser, at the target.

Do this a few times and then see how the person reacts when she sees you. There should be some change.

There may even be a dramatic change but sometimes that requires more work.

So try this and see what happens. When you find yourself in sight of her, do a quick charge like when you played your little pranks on the street, only this time fire up the root chakra and see the beam hitting her right between the legs. Think of it as a psychic dildo!

Do not stare while you are doing this. That will make her put up a defense. Just look in the general direction but avoid looking directly at her. Let the psychic energy do the dirty work. With some practice you may even be able to make her have an orgasm from across the room, but that takes a lot of energy and do not be disappointed if you do not get those kind of results right away. It will come, you should pardon the bad pun, in time.

Of course you do not have to use this with the intent of getting her into bed. You can also do this to have some nasty fun but the brow chakra works even better for that.

The brow chakra is the psychic workhorse. It is the primary emitter of information-bearing psychic energy when fired off in conjunction with either minor chakras in the eyes or the hands. Spend a lot of time working with this chakra.

Again, bring the energy down into the top of your head and this time concentrate it in the center of your forehead. Close your eyes and see the bright, indigo light swirling there. Hold that light there for a time letting it get brighter and brighter and then, open your eyes and fire the light out of them!



Play with that a few times and then set up a target, something simple like a circle on a piece of paper. Repeat the procedure only this time aim at the circle and see the beam illuminating it. With some practice you may even actually see the circle lighten in front of you.

Ok, now it is time to go out and play. This is a technique I love to teach because it makes what we do simple and fun, as well as allowing people to have a good laugh when they get home. I created it as a prank that was easy to describe to people on the radio during interviews because it never fails to get a chuckle at the very least, but when put into a bdsm cultural context, it takes on an added meaning.

Take yourself somewhere where you will be sitting a bit to the back of an attractive, young woman. If you can stand it, or have a reason to be there, like a wedding or a funeral, a church is perfect.

Now, close your eyes for a second and do a quick charge. Open your eyes and fire at the target, at the same time seeing her in a flame, thinking heat at her. Imagine that she is burning up in front of you, that her skin is actually starting to singe.

While you are doing that, think at her telling her that she is hot, the room is hot and she is cooking. Keep that up for a few minutes and watch as she unconsciously starts to take her clothes off, reaching up to unbutton her blouse, only to stop herself in embarrassment wondering what could have possessed her to start undressing in church!

Congratulations. You have just run a really good, non-consensual humiliation scene. And there is nothing anyone can do about it. After all, what are they going to say? And what can they possibly do?

Can you just hear the purists whining out there?

We have one more basic field technique to cover and that is using the hands to direct energy.

The energy field coming out of the hands is the easiest to detect. Simply point the fingers of one hand at the palm of the other and slowly move the hands back and forth. You will feel something like a small breeze or coolness at the points on the palm of your one hand where the fingers of the other are pointing.

Repeat this procedure with the fingers of each hand pointing at each other and you will feel a similar thing between them. If you hold them near a white piece of paper you will even see something similar to the illustration.

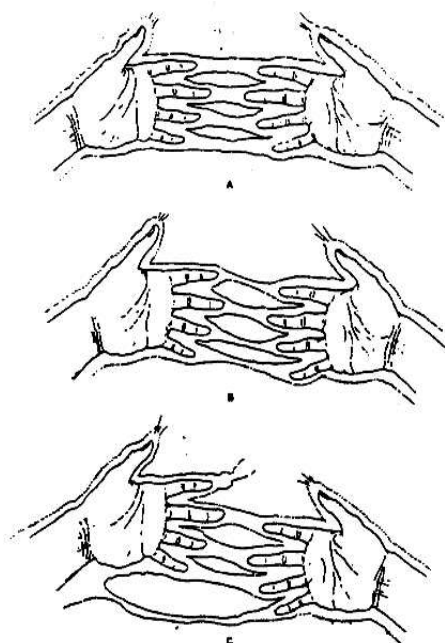

This is the energy coming off your fingers in normal, daily life. If you charge yourself up, you can make that energy do some pretty amazing things. The key to all this is that there are small chakras, called Minor Chakras in the palm of each hand and at the tip of each finger. By energizing these chakras, you can project a stream of energy like a flashlight beam which will interact with the energy field of the target and, in doing so, impact on her nervous system causing involuntary muscle reactions.

This is a basic little exercise that is fun and can greatly alleviate boredom at weddings. In fact I used it on people in front of me at a wedding and the future Mrs. Chuckie was most annoyed and kept telling me to stop it. Of course I ignored her.

Go somewhere where you can sit behind your unsuspecting victim. A movie theater works good for this if you do not have a wedding handy.

Give yourself a fast charge only this time bring the energy through your arms into your hands and to the tips of your fingers. Now, slightly raise your right hand and point at the back of your target. Wiggle the index finger like you are tickling the person while seeing energy from your finger acting as an extension of the finger doing just that. Most of the time the person will start to itch and wriggle like they are being gently tickled. You can drive a person crazy doing this, which is what makes it a good thing to do.

Torment the target as long as desired and have a good laugh at her expense on the way home.

Just think of the poor dummy in the dungeon social area in his sacred leather itching like crazy. He can't scratch through the leather and he can't take the leather off because it is sacred. So he stands and itches until he loses control of his bladder.

There are a number of techniques in play which also involve the interaction of the energy field of the top with that of the bottom and which involve no toys whatsoever. These techniques have the added advantage of totally mystifying Dungeon Monitors at large events and confusing onlookers terribly, which will, of course, add to your reputation as an amazing player. When Mrs. Chuckie and I were first together, she would say that I could do more with my fingers than most people could with an entire toy bag and this is the reason why. So we will come back to the human energy field often. It is our principal medium.

IV

Basic Psionics II--Thoughtforms

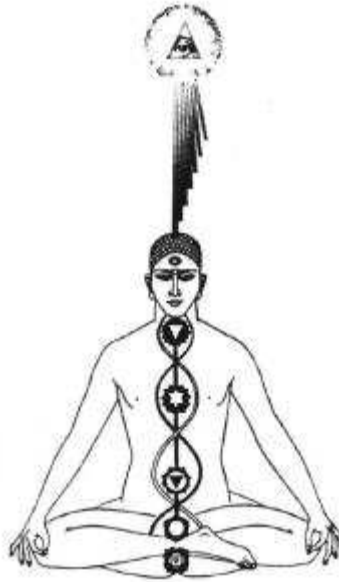

Thoughtforms are clumps of psychic stuff that are created every time someone thinks very hard about something. If you were to look at the energy field of any given individual, there would be a continuous effect of blinking lights, something like a Christmas Tree gone berserk. These lights are thoughtforms and most of them tend to be very transitory phenomena, lasting only a few seconds at most before the energy placed in them burns out and they just sort of disappear. Some will last longer, a few minutes before dying and then some will just sort of go on forever. Those are the ones put there by significant events in a person's life and they never die because there is some part of the consciousness that is constantly reliving the event or being reminded of it. These are called engrams and can only be removed by an auditor with the help of an e-meter. CHUCK!!!!!! Ok, I had to put a little joke in.

But there is another type of thoughtform and that is one deliberately constructed by an individual to serve a specific end and that is the type we are going to be concerned with here. Such thoughtforms are the principal weapons in the arsenal and everyone should know how to make and use them. Think of them as psychic transmitters that just keep broadcasting your desire until they lose power or the desire is fulfilled.

There are two ways to make a thoughtform and both are very easy. All you need is a good, strong imagination and an idea of what the thoughtform is supposed to do.

The first way is to simply close your eyes and see a figure, a form that the thoughtform is going to take. Keep it simple, something like a ball, something easy to visualize and remember.

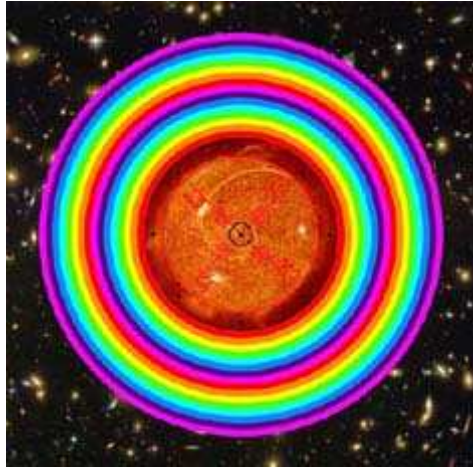

This is a pretty generic thoughtform. It is a simple multilayered sphere and you can make it even simpler by just visualizing the center without all the pretty colors.

Now, once you have done that, you need to charge it and program it. You do that by visualizing it as being filled with light, like an empty bottle being filled with colored water and saying that it is being charged to perform a specific task, like bring you someone to play with Saturday night at the dungeon.

Once you have done that, send it on its way into the ether and forget about it. It will do its work without any further effort on your part.

The other method is to create a thoughtform using power brought through your hand chakras. For this method, you begin by first charging yourself up and then focusing the energy into the palms of your hands. Once you have done that, hold your hands a few inches apart and visualize the energy flowing out of the palms of your hands forming a ball between them. As you pack the ball with energy, much as if you were packing a snowball, again you program it with your desire, which in this case may be something that requires an immediate burst of energy, sort of like a psychic hand grenade bursting on a target. You fill this one until you feel, and you will actually feel, your hands being pushed by it and then you release it at the target to explode and cause the target to respond to your desire. This is a good one for pranks. We use to it to get rid of annoying, noisy nillers at tables near our Slosh group when the bar is too crowded.

I've also been known to use it in a restaurant while having dinner if there is a large family nearby. There are few things more entertaining than watching a screaming brawl break out at the next table. And if you have the misfortune to be near a table with squealing brats, you can make the parents so annoyed that they will commit child abuse right there in front of god and everyone and the police will come and arrest them and everyone will get all shocked and you will get a real good laugh on the way home.

So as you can see, thoughtforms are no great problem to create and use. And once you have mastered the simple ones, you can create all sorts of useful things for everything from bringing you a reliable play partner to filling up your group with the kind

of people you want to have around, to repelling people who might be a problem for you. It is all simply a matter of visualization.

You can even use them to draw energy from others playing and make the energy of your own play broadcast to the unconscious minds of everyone in the world. There are few limits as to what you can do with a good thoughtform.

Of course some thoughtforms need a lot of power and if you are using a thoughtform to draw energy or information from, you will need to be able to contact it. For that you need to name the thoughtform and create a pattern that will allow you to contact it with little difficulty.

Picking the name is pretty easy. You just come up with a name for the thoughtform, in this case let us say to bring you a slave. So you name the thoughtform Slaver. Now you have to create a pattern to allow you to contact Slaver when you need to give it a charge, which you should probably do every few days until you get what you are after. In order to do this, you need a template to make the pattern from. This is one used by magicians and it works as well as any other so:

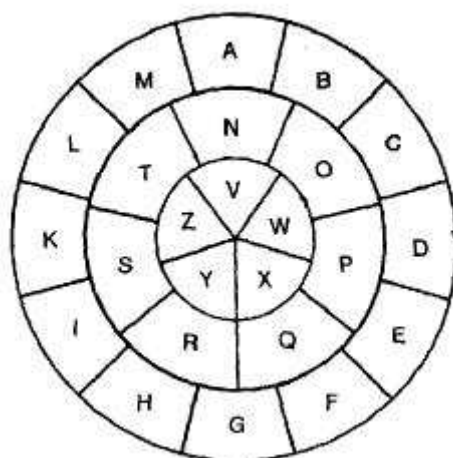

You will notice that it has most of the letters but J and U are missing. That is no problem, just use I and V in their place.

So you take the template and you make a line between S and L like this:

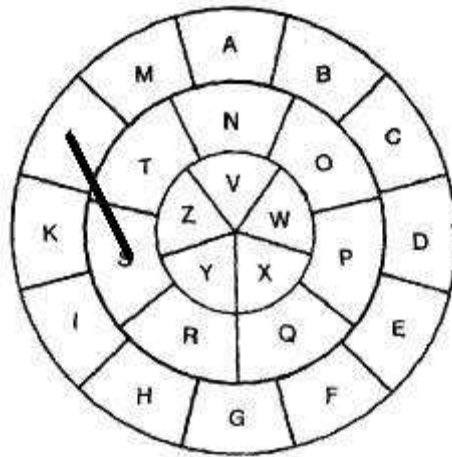

Then you make one between L and A.

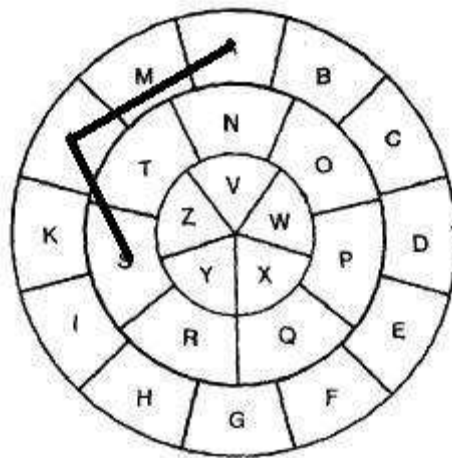

Next from A to V.

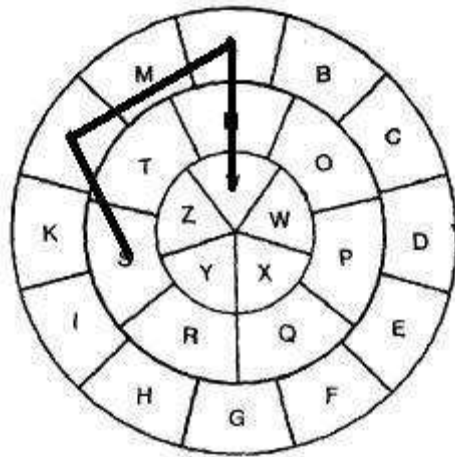

V to E.

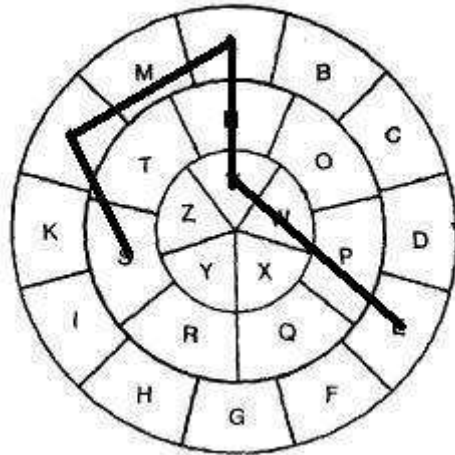

And finally from E to R.

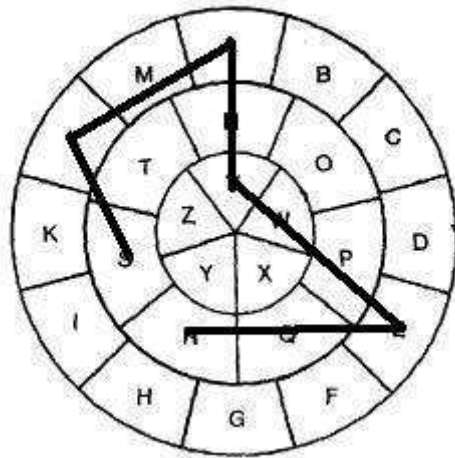

Now all you need do is trace the pattern onto a piece of paper, write Slaver on the paper so you know what it is, and then put it in a safe place. When you need to contact the thoughtform, bring it out and hold it. You will be in immediate mental contact with your creation and you can work with it with no trouble.

Anyway, this pretty much covers the basics of thoughtform making. We'll be using them a lot so get used to working with them.

And to get you started, here is a fun little exercise.

Go someplace where there are attractive and unsuspecting people, like a club. Pick your victim and make a thoughtform in your hands. Charge this thoughtform with the energy from your root chakra and when it is good and strong, let it fly at the pelvis of your target. She should suddenly feel a tingling and have no idea where it is coming from, just like when you used the energy field.

Now, make another thoughtform, only this one you design to make the person she is eyeing, assuming that it is not you, totally dislike her. Let it fly at him.

Sit back and watch the fun.

V

The Machines!

Psionics is about using gadgets. Anyone can do the stuff with the energy field and the thoughtforms but for it to be called psionics, other things have to be involved and these can range from simple patterns on paper to large consoles with all manner of electronic gewgaws, whistles, bells, lasers, radar, nuclear power, the works. For this reason psionics can seem a bit intimidating at first, but it is actually very easy to work with because the gadgets that you will need are actually very very simple.

Let's start with the pendulum.

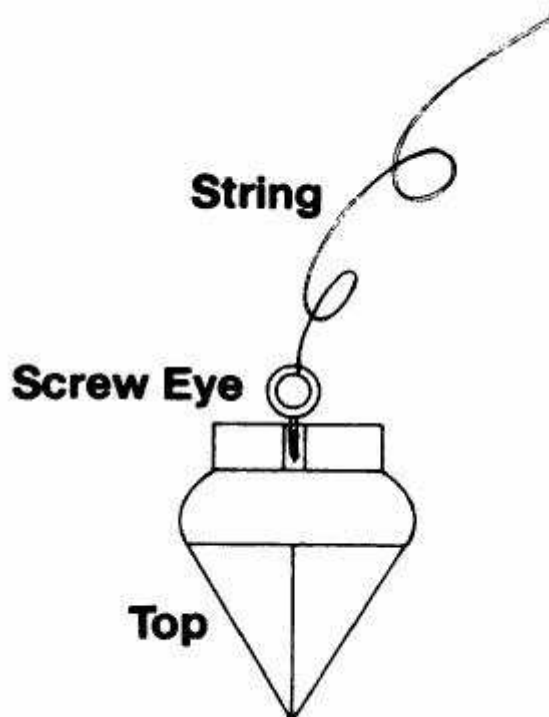

Now this is as about as easy as you think it can get--nothing more than a weight suspended from a string. And that is all that it really is. Yet this device can give you more information than you may need, or even want. By using it you can find out almost anything about your chosen vic-er-partner, including stuff that she probably would rather that you did not know, like about the three years that she spent in prison for trying to shoot her last dom.

The pendulum in the illustration is an old favorite of mine. It is nothing more than a child's wooden top with a screw-eye attached to a length of string. I like it because it has a lot of weight relative to the string and it comes to a point which means that when it is dangled over a chart it will point to what it is supposed to and not leave you confused. And as I confuse rather easily at times this is an important quality. Of

course any pointed weight will do, like an old key. It is not necessary to go out and spend money for a gold pendulum with a brass chain. That is silliness.

Once you have your pendulum, you need to train it, or rather you, to be able to understand the answers to your questions. This is, again, very easy.

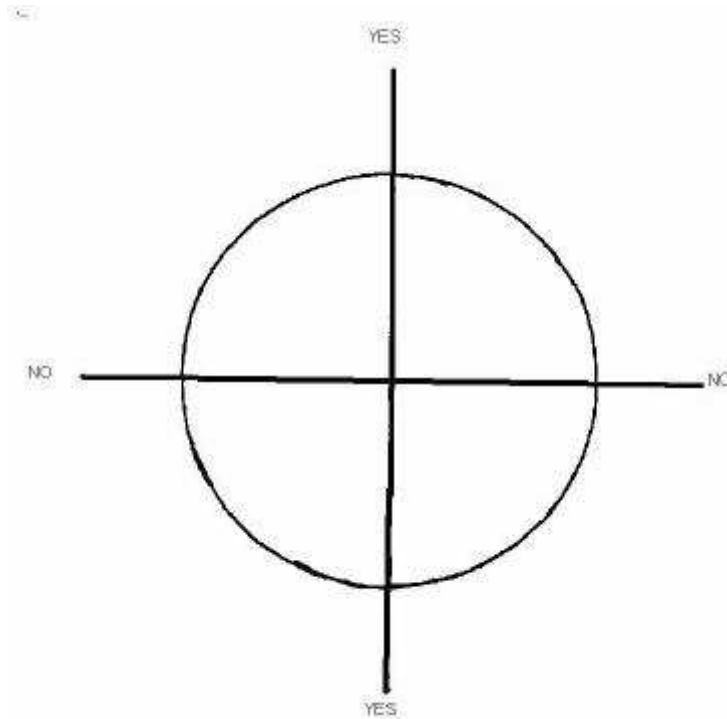

This chart is called an ideometer, not to be confused with the idiot author who did not know what it was called at a book convention and managed to make himself look very silly years ago. (Now who could that have been?) Anyway (we don't have to go into that, it was embarrassing), as you can see this chart is a circle with cross hairs. The vertical lines mean yes and the horizontal lines mean no. The circle itself means "I have no idea what the hell you're talking about." To train the pendulum, you hold it so that the point is over the center and think of a question to which you that the answer is "Yes," such as, "Is Guy Baldwin a waste of skin?" The pendulum will move slowly at first but will follow the vertical line.

Repeat the procedure with a question to which you know that the answer is "No," such as "Can Uncle Chuckie ever be wrong?" The pendulum will follow the horizontal line. It's kind of like nodding your head for yes and shaking it for no.

What is going on is that your brain is causing the muscles of your hand and arm to move very slightly and that is what is moving the pendulum. No matter what your Aunt Mathilda says, it is not evil spirits grabbing your arm.

For obvious reasons you use this to get very simple yes or no answers to questions. It is not very good for anything more complicated than that. If you need to know something that requires words, we have a chart for that as well.

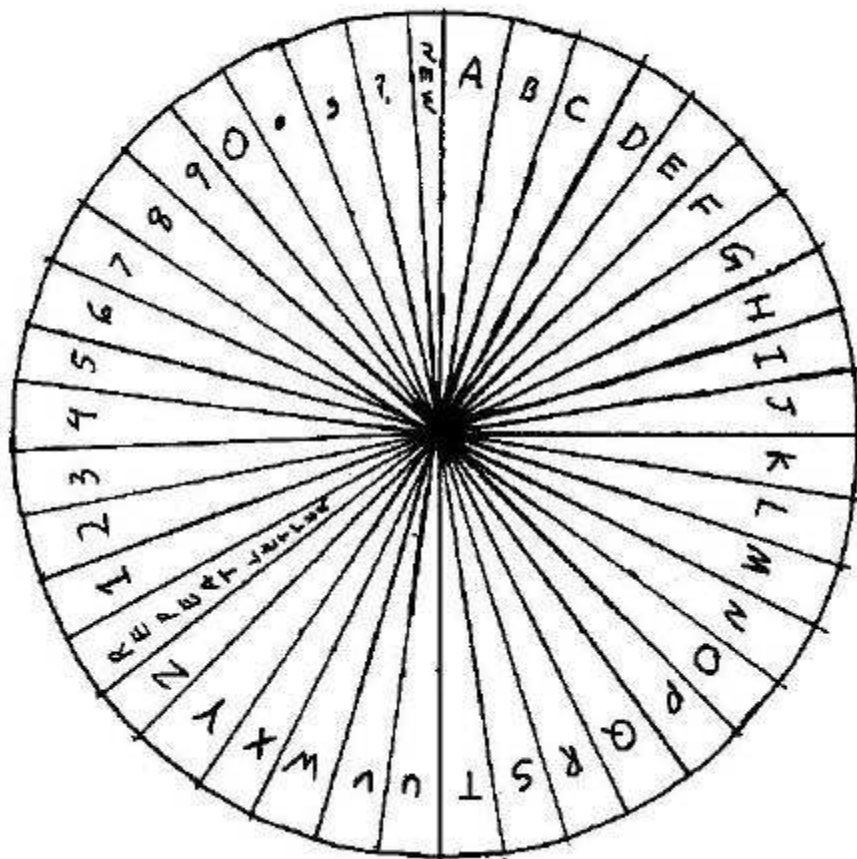

This chart is designed for pendulum communication in the same manner as an old-fashioned Ouija Board. Actually it is much older than that redoubtable instrument as we have records of such charts being used in ancient Rome, usually engraved on a table specifically designed for such things. This version is my own, and I made a few improvements over previous designs in that I include punctuation marks and a space for repeat letters as well as one to indicate a new word.

Now normally these charts would be used to get messages from the great beyond, like your dead Uncle Lou telling you which horses to bet on tomorrow. But for our purposes we will be content to use this one for getting messages from the subconscious mind.

In use, you hold the pendulum over the center and ask the question, such as which horse is going to win in the Fifth, or, for the purposes of this book, who in the munch group likes me? (And with any luck it will not spell "No one.") In other words, this thing is perfect for spelling out names and short pieces of advice on how to proceed with someone. Its use is predicated on the notion that unconsciously we know a lot more than we know consciously, from body language and speech inflection, and by communicating with that subconscious we can more effectively get laid.

A word of advice however. There is no way to keep your arm from getting tired using this instrument, so try to confine your questions to those which will only need short answers.

After you have worked with a pendulum for a bit it is time to play with the stick pad. A stick pad is nothing more than a plastic lid from a coffee can or the lids they sell to close cans of pet food. It is important that it be smooth, other than that, any of them will do.

You put the stick pad on a table in front of you and rub it gently with the thumb of your right hand while asking a question that you know the answer will be "Yes," such as "Is Uncle Chuckie the greatest mind of the new millennium?" What will happen is that after a few rubs the pad will sort of grab your thumb. It is impossible to describe what this feels like but you will know when it happens.

With that we come to the next chart--the Pervometer!

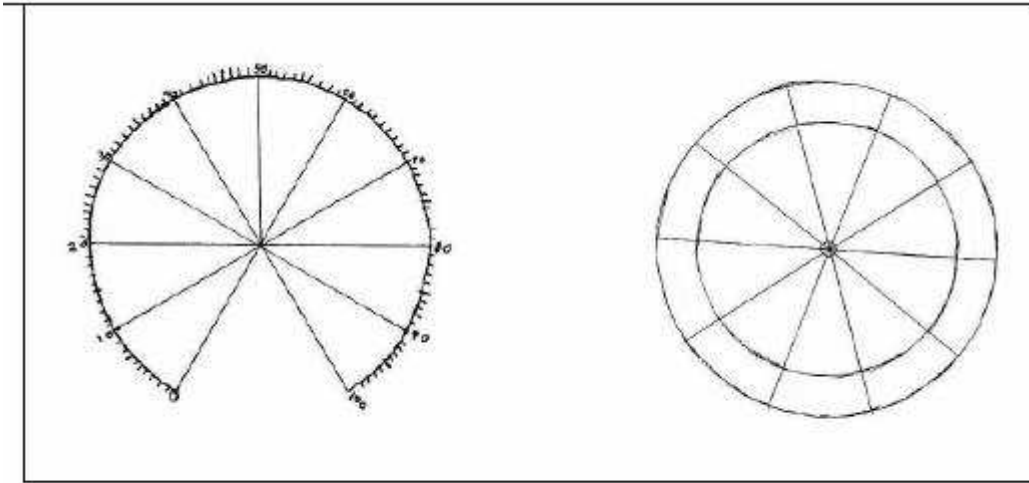

This chart is actually two charts put together. The first is a dial that goes from 0 to 100

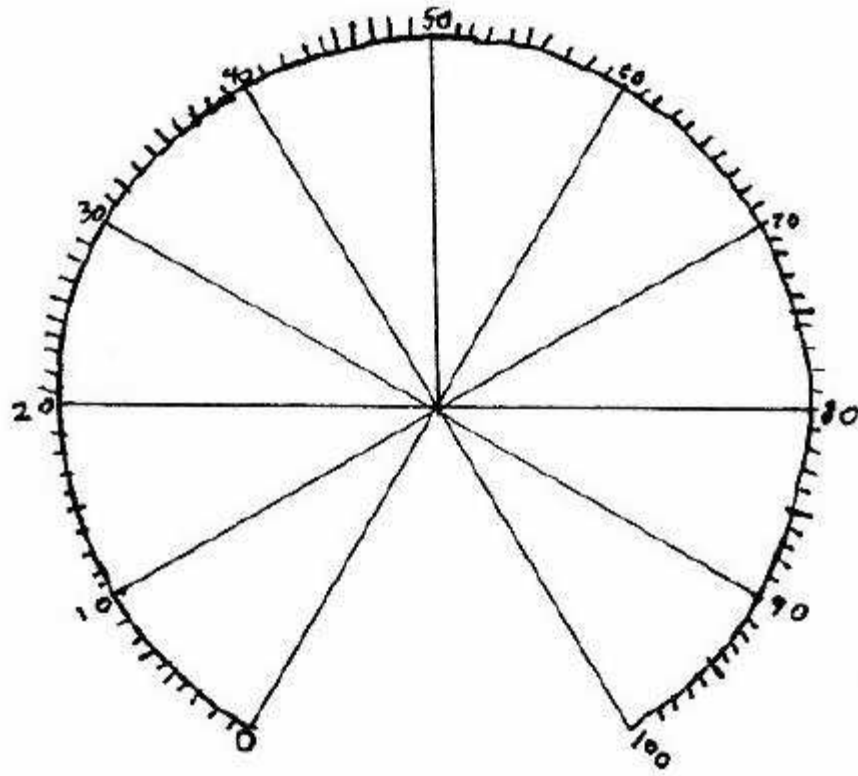

And the second is a simple circle divided into sections.

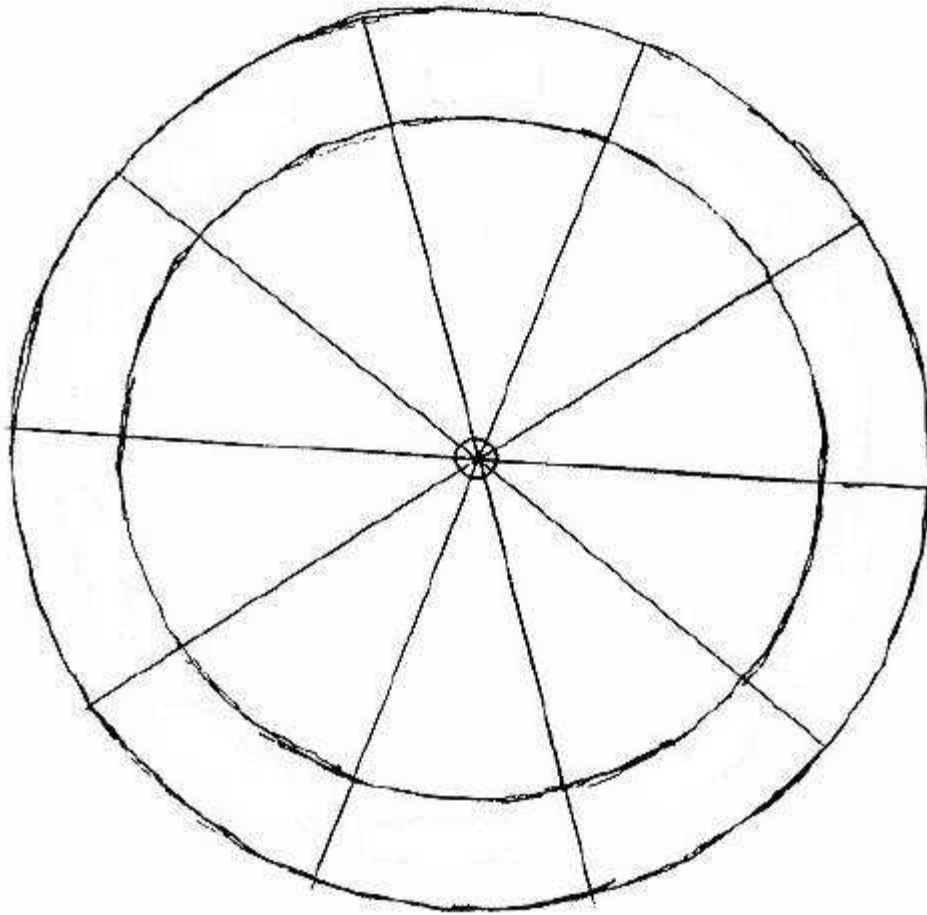

In each section you write a particular activity that you like. This wheel is divided into ten sections but you can make one with as many sections as you want. In each section of this wheel you write down an activity that you are interested, such as bondage, electric play, noose play, etc..

Now, there are a couple of ways to use this chart. One is to make a pointer for each wheel out of poster board and attach it to the center of the chart with a brad so that it turns as a dial, or the other is to simply hold the pendulum over the wheels of the chart. If you use the pointer, then you can use the stick pad.

In either case, you first decide upon your victim and if you can get photograph of her, such as from an online site, so much the better, but otherwise just writing her name on a piece of paper will do. This will give you something to concentrate upon.

Put the witness, which is what I was just talking about, in front of you and either set the pointer to an activity or hold the pendulum over it. If the stick pad or the pendulum says "Yes," mark that down on a piece of paper. Then test the numbered dial to find out what level of interest the person has in that activity, so you might get Bondage--75.

That is a high reading and indicates that you should see to your rope supply when you connect with this person.

You repeat that with all the activities on the wheel and when you are done you will have a list of things you like that the other person does and the relative level of interest in each, the higher the number, the greater the interest.

You can well imagine how much easier this little instrument makes things. Instead of having to go through complicated negotiations with lots of hemming and hawing and neither of you quite knowing what to say, you can get right to the point and she will be totally amazed at how you know just what she is interested in.

And, just as importantly, you will know if the person is not into what you are and you will not have to waste any time. When I designed this thing many years ago I made a point to put in activities that I wanted nothing to do with so I would know if she was interested in something that I could not stand. It saved me a lot of trouble.

Now it is time to build a couple of things. They may seem intimidating at first but do not worry, when you actually start to work they are rather easy to construct.

The first thing you need to build is a psionic amplifying helmet. What this does is boost your output in transmission and allows a direct connection to other equipment in reception.

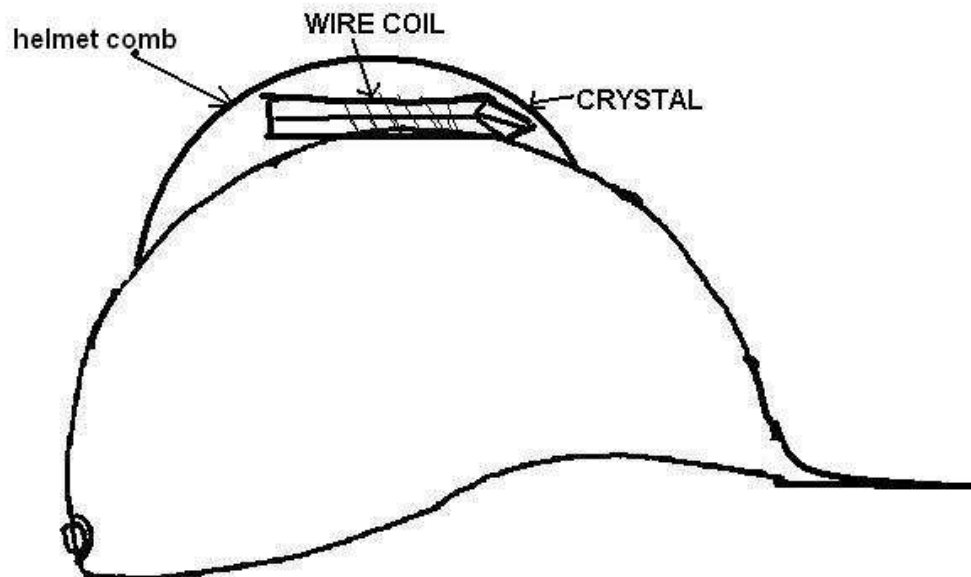

To make this you will need:

1 hard hat.

A circle of foil.

8 small magnets (pieces of magnet strip with adhesive backing work perfectly)

a small jack to plug things into

a crystal

some wire

some glue.

Take the liner out of the hard hat.

Drill a small hole in the hard hat at the back, it should be a little larger than the diameter of the jack without the nut that holds it in place.

Glue the crystal to the inside of the comb on the top of the hard hat. Glue the wire to the crystal with a tail long enough to attach to the foil plate on the liner.

Glue the circle of foil to the part of the liner that will rest on the top of your head.

Attach two lengths of wire to the jack and attach it to the hole in the back of the helmet by unscrewing the nut, putting the stem through the hole and then screwing the nut back on over it to hold it in place with the wires on the inside of the helmet.

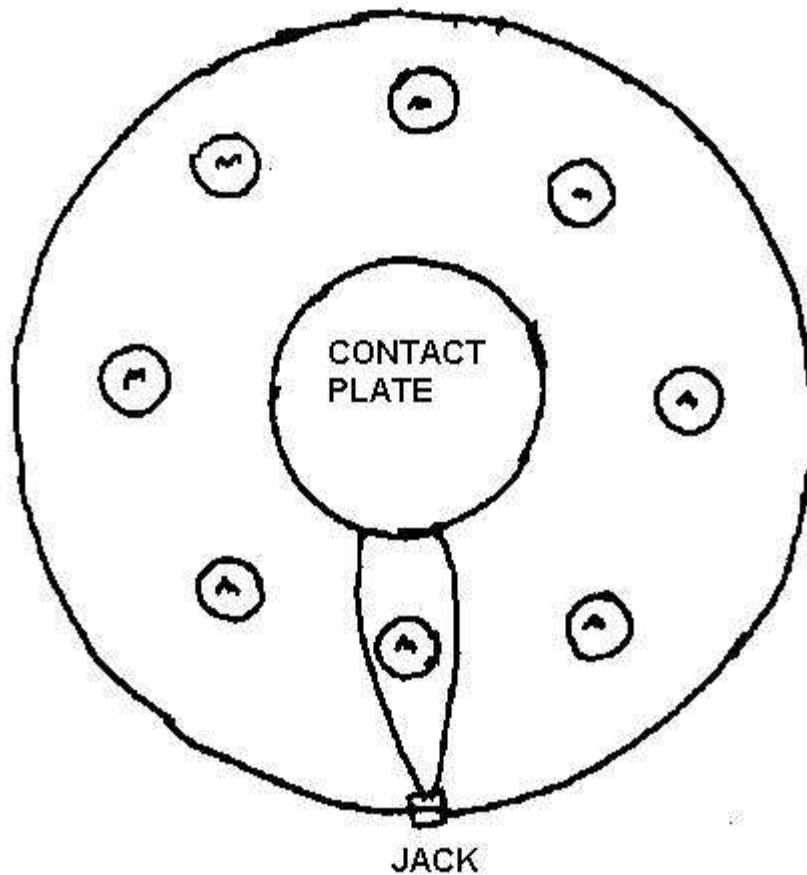

Stick the magnets around the inside of the hard hat as in the illustration.

Now, put the liner in and attach the wire from the crystal to the contact plate. Attach the wires from the jack.

The helmet is now complete.

Give the glue on the crystal a chance to harden and then try out the helmet. You do that by putting it on, sitting and just letting your mind work. You will know what I'm talking about once you do that. Again, it is something very hard, if not impossible to describe.

You use the helmet to boost your power when at home or in the play space. With all the silly things scene people wear, you don't have to worry about what anyone will think. It looks better than those stupid biker hats and because it looks like an ordinary hard hat people will just think it is part of your kink, which it is. (It goes very nice with goggles and a respirator.) It will make your work much more effective but it is probably not a good idea to wear it in a restaurant. It is very impolite to wear a hat at the dinner table. Only proles do that.

There is one more complicated thing you need to make and then it gets very easy. You now get to make a radionic box.

It is possible to write books about radionic boxes all by themselves, and people actually have, including me, but all you need to know is that this simple machine establishes a relationship between the mind of the operator and the subject of the operation. It is a psychic labor-saving device. It enables you to lock in on the subject and transmit to it, such as charging or receiving energy from a thoughtform, or contact a person and send thoughts directly to that person.

It can do other things as well but we don't have to deal with them here.

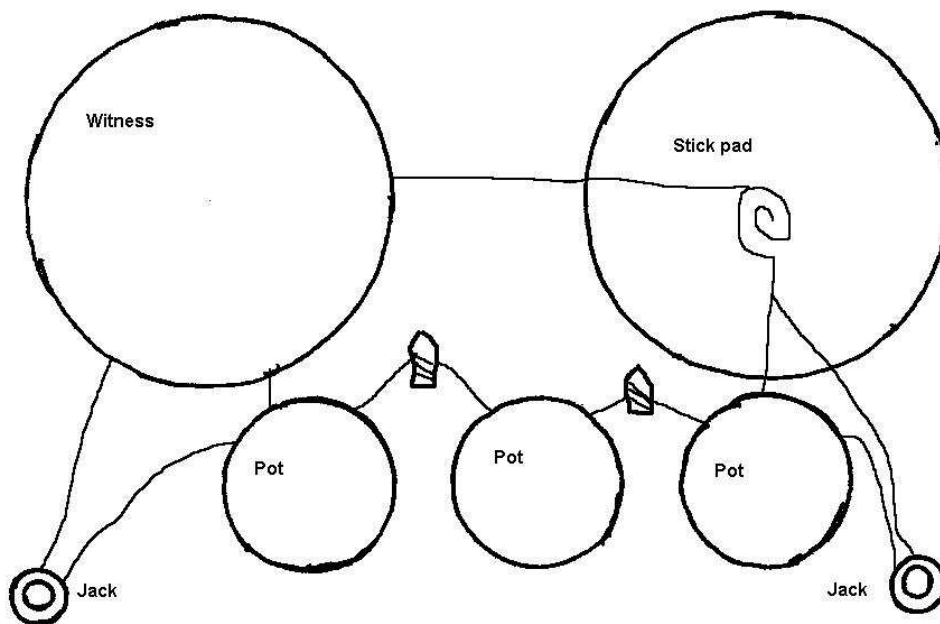

This is the layout of a basic radionic box. People charge lots of money for these things but you can make one rather cheaply.

To make this unit you will need:

A box, a cardboard box will do or if you want to get fancy, a plastic pencil box works.

Three potentiometers, value unimportant (this gadget is not really electronic, it just looks like it is)

Three knobs for the potentiometers.

Two crystals.

Two jacks.

a can for the witness with two screws to hold it to the box and act as binding posts for wires.

A plastic lid for the stick pad.

Wire.

Begin by laying out on the box where you want everything to go. Once you have done that, drill the holes in the box for the pots, the jacks, the screws to hold the can for the witness (and connect to the system) and the coil under the stick pad.

Put the box aside and wire the jacks, the pots and the crystals as in the illustration.

Make a coil of wire.

Put the innards of the box together.

Attach the can to the box and wire it to the left hand jack as in the illustration.

Put the coil on the outside of the box and run the wires inside it to attach to the right hand jack and the witness can as in the illustration.

Close the box and attach the knobs to the pots.

And the box is ready.



Guess who this is holding a completed box. The helmet is the very first one I ever made, back in 1977, and the crystal antennae are under the horn-like cylinders. From looking at this picture you can probably guess how the system works. You will need to get a patch cable to go from the helmet to the box to make the connection.

So now it is time to take it out for a test run. Create a thoughtform and a pattern to correspond to that thoughtform. Once you have done that, put the pattern in the witness can and set up the box by taking what is called a "rate." The rate is simply what the numbers on the dials say when they are set. It is nothing more than an expression of the relationship between your mind and, in this case, the thoughtform you will be working with.

Once you have the contact rate for the thoughtform, plug in the helmet and put it on. Now relax and close your eyes. You will see the thoughtform clearly and once you do that, visualize it as being filled with energy, like a bottle being filled with colored water. As you do that, know that the thoughtform is being given more and more power to achieve the end that you have programmed it for. Do this for a few minutes and then take off the helmet, set the dials back to the starting point and put the pattern in a safe place until you need it again.

Another fun experiment. Get a witness of someone you want to play with. Put the witness of her on the transmittal side of the machine and set the rate while thinking of her pelvic chakra. This will focus the machine on that chakra. Now, put on the helmet and send energy to her through that chakra and see how she responds to you next time you see her.

See how simple that was?

You can use the box for all sorts of things and we will cover them in their turn. But now it is time to get to the really simple things, like the hand resonator and simple light sources.

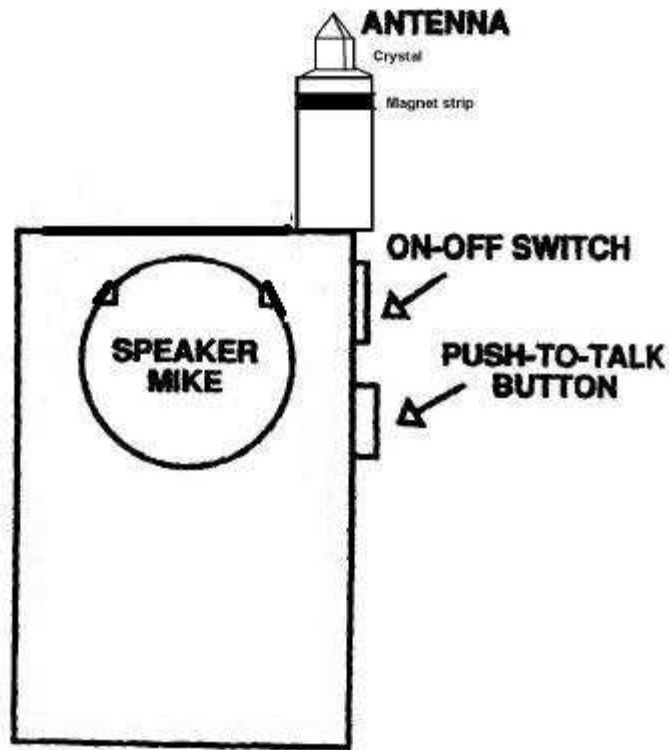

The hand resonator is another one of those devices that is actually very easy to make.,.

All you will need is a cheap walkie talkie, a short length of narrow plastic pipe just long enough to be a bit longer than the antenna of the walkie talkie, a crystal that will fit into the pipe end, some adhesive magnet strip and some glue.

Fit the pipe over the antenna and glue it in place to the case of the walkie talkie. Glue the crystal to the end of the pipe. When the glue has set, wrap the magnet strip a couple of times around the pipe. That is all you need to do.

What you have just done is create a psionic transmitter that is surprisingly effective not only for sending things to people, but also when used in play because the bottom will usually feel it.

So how does it work? Well, in the original model which I have on my websites, there was a contact plate on the outside for the palm of the hand to fit over and thus have a direct contact with the hand chakra. It turns out that that plate is not necessary. If you are holding the instrument with the microphone near the palm of your hand even if not directly on it, the microphone is in the electromagnetic field of your hand and the chakra, and thus what you put out will get into the instrument and be amplified using

the radio transmission as a carrier wave. The crystal acts as a further amplifier and when the instrument is pointed at a person, whatever you are putting into it will hit the field of that person and cause a response which actually can be physically felt, which is why the hand resonator is perfect for demos.

You can prove this by using it in play.

Tie up your bottom stark naked and blindfold her. Stand near her with the resonator held as I describe holding down the talk button when you turn it on. This will prevent it from making walkie-talkie noises and letting her know that the instrument is on.

Move the instrument over her chakras in a circular motion. She will feel it and not quite know what it is that she is feeling. Now, sometimes this can be rather dramatic. One time I pointed the resonator between the legs of our victim and she literally jumped in the ropes, causing someone near us to say to me, "I'm not playing with you!" as we all burst out laughing.

This is also the perfect instrument for event play parties because it will drive the dungeon monitors to absolute distraction trying to figure out what it is. At one Vicious Valentine, I was playing with Mrs. Chuckie and using the resonator. We had six DMs standing around us wondering what I was doing because the instrument makes no contact with the skin and they had never seen anything like it. Remember, for all their inventiveness, scene people can be easily confused by things that do not fit their way of doing things. This is known as non-consensual DM play.

And consider this. With this instrument you can zap people on the other side of a room without their consent. You just sit in the social area and aim it at someone and fire. Their energy field will go all bouncy and they will have no idea where it is coming from as long as they do not know about the gadget and what you do with it. It is the perfect instrument for a lazy dom. One time we had our sub tied to a chair and blindfolded on one side of the dungeon while I sat on the other side and just fired the resonator at her. She felt it. And so did the person standing next to her!

As with all psionic instruments, there does not seem to be a range limitation and it is possible to zap someone with it at very long range, like miles. All you do is take up the instrument, turn it on and transmit while visualizing the part of the target you are hitting. I know that makes no material sense, but it works and it can be very disconcerting to someone to be turned on for no reason in the middle of a political banquet. When I first created it I literally drove a state legislator crazy by doing that. She never knew what was going to happen to her or when and she would do most bizarre things in the legislature because of it, to the point where her own party re-districted her out of office because her behavior had become such an embarrassment. So you see with psionics you can accomplish all manner of things and have fun at the same time.

It gets simpler.

There are two more instruments you will need, a headlamp, of the sort found in camping departments and a six-volt lantern. The reason for these is that light functions as both a carrier wave for the energies we use as well as a focusing agent for them. I'm living proof.

Some years ago I managed to get very sick. And I ended up in the hospital for four months which was no fun at all. I was neither getting worse nor getting any better and it was becoming damned frustrating for me and my wife! Well, my wife, who actually has never read anything I have ever written except for a few short pieces on a magick website that I was looking at when she came into the office one night, independently hit on the idea of using focused light to heal me.

On the Friday before Xmas, which was also the winter solstice, she arranged for all the people at our Slosh to aim flashlights on my picture and think healing thoughts. They did this with an amazing enthusiasm for which I will always be grateful, including one friend who brought a million-candlepower spotlight. And it worked. I was home in exactly a week! (And for those who thought that my illness was karma for all the nasty things I had done, my rapid recovery was a great blow to their philosophy.)

Using the headlamp in play is something that I sort of hit on by accident. Years ago I created a helmet with a large spotlight in front for play because the dungeons tended to be dark and I did not want to accidentally turn my pain-slut sub into hamburger. If flogging her was going to be a blood sport I wanted it to be on purpose!



Anyway, as you can probably guess, the helmet is heavy and hot and uncomfortable and the battery and the wire are a pain to deal with so I don't like to use it very often now. By the way, for those familiar with my gadgets, the horns and the crest are simply decorations. This was not intended to be a psionic instrument.

But I still want light and a headlamp has the advantage of leaving your hands free to rummage in your toybag.

But if you look at the next picture...



You will see that the lamp and its power source are right over the third eye, the brow chakra, well within the field of that chakra. Thus you can charge the light directly from the energy of the brow chakra. The effect of this is that the energy of the chakra can be sent along the light beam as a carrier wave directly to the target, who is sitting naked, tied to a chair in front of you.

Anything you put into that light, you can put into her. With practice, you can so energize her chakras with energy that will produce orgasm with no other contact. (More on that later.) The headlamp also is very useful for finding things in the toybag so no one will think more than twice about seeing you wearing it--until you start using it to play with your sub.

The six-volt lantern is used for something else entirely.



Forgive the ectoplasm in the picture. It happens in the lab sometimes from the equipment I have running. (I'm joking. The lines are from some peculiarity in the word processor.)

Anyway, from the photo you can guess how this thing is used. It is a transmitter and it is used in conjunction with the helmet, a foil plate and a patch cable clipped to the plate.

The lantern is stood on its ass on the plate pointing straight up. The energy from the operator goes through the helmet, where it is given amplification, to the plate and the battery of the light is in the field coming off the plate. (These fields usually extend for several inches.) The battery is charged with the energy and the electricity coming out of it goes into the light where it becomes a concentrated carrier wave.

In use, a witness, such as a photograph, is placed on the lens of the lantern so that the light will bathe it. Put on the helmet, concentrate on what you want to send to the target, turn on the light and just think and visualize. The energy that you put out will be sent inexorably to the field of the target and thence to her subconscious. The advantage of this system over the headlamp or just holding a flashlight aimed at the witness sample is that by using the helmet as the connecting point, you gain the advantage of the magnets in the helmet boosting your field and by not having to aim a flashlight or keep the headlamp aimed at the witness, you can sit and relax, close your eyes and visualize. It makes things a lot easier and it is an amazingly effective system, much more effective than even the wishing machines that are being sold commercially and they are mostly very good units.

If you really want to boost your power, you hook the helmet to input (left) side of the box, take a contact rate for the target and then daisy chain the plate to the output (right) side of the box and put the lantern on it with the witness on the lens of the lantern. This system gives you a more accurate lock on the energy of the target and enables you to add the energy of a thoughtform to your own by putting the pattern witness of that thoughtform into the witness can. That done, you just put on the helmet and transmit.

This pretty much covers the instruments that you will need. As you go along you will learn to combine them to really increase your power and the effectiveness of your operations.

VI

Remote viewing

One of the most important and useful skills you will need is remote viewing. It is nothing more than the means to gain information about a potential target that would not be available by other means.

We have to begin this with the fact that while the phrase, "remote viewing" is pretty recent, the activity itself is nothing new, in fact it is probably as old as humans on this planet. It used to be called "clairvoyance" but that term now pretty much means predicting the future. There are actually a number of historic examples of this, some going way back. Older writers used to love to repeat the story of the time Emmanuel Swedenborg (he used to matter) left a dinner party in 1759 and came back in terrified and not of the grumpy wine steward. It seems that there was this huge fire in Stockholm, which was about two hundred miles away but the prophet was ultimately greatly relieved when the fire was put out three houses away from his! The Patron Saint of Television (there really is one!) was a woman who apparently was able to watch church services from her sickbed some distance from the church. Now why she would want to do that instead of watching the Flash Gordon serials on television in the future is beyond me, but there is truly no accounting for taste. She probably did not even really enjoy being flogged. What am I saying? She was a saint, of course she enjoyed being flogged! The idiot probably thought the orgasm was something spiritual!

In the middle of the nineteenth century the art of psychometry was popularized. This is the talent for taking an object and being able to psychically sense what has gone on around that object. The theory behind that is that the object picks up the energy field of the activity around and that field is then readable by the psychometrist. Does that sound familiar? When we use psionics to aid in remote viewing, we are basically doing psychometry with the added advantage provided by our instruments. The advantage to this method lies in the fact it is not necessary to in any way concentrate upon the target of the viewing. The instrument does all the heavy lifting and the viewer need only relax and watch, sort of like watching television but without the annoyance of commercials and idiot talking heads.

In order to use this system in actual remote viewing, it is first necessary to have what is called a witness, which can be anything that links your mind to the target, a photograph, something from the particular place if a place is the target, or something that has been in contact with a person. A photocopied signature will work very well.

The witness is placed in the sample can of the radionic box and the box is tuned, as I just described. Then the helmet is plugged in. You put the helmet on and relax. That will open up your mind to the impressions that will come from the target.

During the viewing, the impressions that are received are largely visual rather using the other senses, but do not be surprised if you were to smell or hear something. Often the images just seem to fill the whole head but sometimes they appear as on a screen at

the point over the nose. In any event, they are there and while the first few tries may seem to get nowhere as multiple images bounce around without making any sense, they become clearer with practice.

As you become adept at this, you will also realize that you are, for all practical purposes, present in the location that you are viewing and can work there psychically, either by direct influence or by creating thoughtforms that will the work for you. This is known as remote presence.

Remote presence is something you will use a lot. It enables you to work at a distance without anyone knowing what you are doing so you can just sit back and watch the fun. We will cover it in more detail soon.

VII

Remote viewing and the watcher thoughtform

If you wish to do some serious remote viewing, a way to make the entire process much easier and effective is to combine the psionic technology with the older method of the thoughtform. The use of thoughtforms for this is an old idea that was made popular by Al Manning in the 1970s. His technique called for making a thoughtform in the shape of a television camera (still big, hulking things in those ancient days of our youth) and programming it to broadcast images to the operator's third eye, or brow chakra. This meant creating the thoughtform and then visualizing a cable running from it to the



chakra.

To use this system, the thoughtform was willed into the location to be viewed and the person just sort of closed his eyes, focused on the region in the center of the forehead and tried to remember what was seen in his mind's eye.

Now as it went, this was a pretty good method of doing things. It was usually reliable with some practice and a lot of fun for beginners because it meant that they could imagine playing with some equipment that was not exactly commonplace in them thar' olden days before camcorders, vcrs, and pc's not to mention dvd recorders and players. With psionics, this method can be made even more efficient. All you will need is the radionic box and helmet.

The thoughtform is made by the simple process of imagination. Close your eyes and visualize a ball in front of you. When you have that image and can hold it for a while make a slight change and transform that image into an eyeball. Yes, the camera is more fun, but it is also more work and the eyeball is just fine.



Give the eyeball-form a name, like Spyeeye or something like that and charge it up like any other thoughtform, seeing it being filled up with the universal energy to power it up and get it running. As you do that, program it by commanding it to send images of what it sees back to you when you contact it.

Work on this for a while until you feel that it is working properly and then make a pattern to contact it as I described earlier.

Once you have done this, set up your instrument by taking a rate for the thoughtform and putting on the helmet for a little practice run.

Sit back, close your eyes and focus your attention on your brow chakra and see what you get. Move the eye around as if it were a floating camera and see through it.

After you have accomplished this to your satisfaction, move the eye out of the room and around the house, out of the house and into your neighbor's bedroom. Do not waste time worrying about the ethics of this because ethics are for weenies and if you were the kind of person to be bothered by such things you would not be reading one of MY books in the first place.

Now this can be fun and if you play the information you get right you may even be able to blackmail the neighbor with it and get your snow shoveled for free. Or, you may find that you are not the only perv on the block and your neighbor has a very nice collection of floggers.

Now you can really get to the useful stuff. Move the eye into the offices of the local police chief and watch him play pass the choirboy with the Archbishop. You can really use that information in the future and the fact that the Mayor is a closet drag queen may come in handy as well. You never know what you will find out.

The important thing to remember in using this stuff is that there are no rules and you are accountable to no one. You can use it in any manner that you see fit and that you are able to do. Just remember that it takes a bit of practice and you start off by looking

for things that you can verify, like what your Aunt Myrtle and Uncle Eustace had for dinner. Once you know that you can do something like this reliably, then you can move on and learn just about anything about anyone that you want to, anywhere in the world. There literally are no secrets and in the face of this people can take their notions of privacy and kiss them goodbye.

One thing that is fun to do is experiment with time vision. Now, the best way to do that is to go back to some recent event that is not too famous but still interesting, like the big fist fight that you heard about that occurred at the neighbor's family reunion two years ago, something you would have sold your mother's grave to see if you had not already sold it to a land developer.

Set up the machine and tune it in to the thoughtform. (Turn on. Tune in. Rule the World.) Now, begin moving the eye back into time to the time and place that you have chosen. Here you can watch the next door neighbor duck under the picnic table for dear life as the beer cans fly overhead, followed by beer bottles and finally coolers. Move the eye way up into the air for a blimp shot of the line of police cars and paddy wagons pulling into the picnic grove.

Play around with the past for a while and start looking in at various parties and scene events. You never know what you might find interesting as long as you don't bother with Guy Baldwin (who hasn't said anything worthwhile in years anyway). Send the watcher into the local dungeon and get some information that you can verify. And then sit back and have a good laugh when people in the scene talk about confidentiality. We know better.

VIII

Beacon Remote Viewing

One of the methods which were used in the remote viewing experiments of the 1970s involved what were termed "beacons." Put very simply, the beacon is a person sent to view the target and the remote viewer, in effect, looked at the target through the beacon's eyes. This technique has a number of advantages research purposes, not the least of which is the possibility of instant verification of the results. The beacon viewed what the remote viewer drew, sculpted or described and would be able to tell exactly and immediately if the viewer was right. For military intelligence work, however, the system has one very serious drawback. If a person could get close enough to the target to physically see it, there is absolutely no need for a remote viewer at all and justifying this stuff to the various congressional committees, staffed by superstitious religious nuts, assorted morons and luddites, in other words, congressmen, would be very difficult. But for our purposes it is an extremely useful tool and starting point for the stuff that is coming next. And it can be great fun as well. One time I knew there was going to be a brouhaha at a meeting of the Esoteric Section of the Theosophical Society but as I was not a member (can you imagine them letting me into that?) I had no way of being there, at least not physically. But the fuss was going to be caused by a friend of mine and I used her as a beacon to watch the excitement and excitement there was. The moment she walked in people's auras all started going bright red and bursting all over the place and I was able to enjoy the show.

With psionics, we are not limited to the use of a voluntary beacon. In fact, psychics who work with police use this all the time, seeing the crime through the eyes of either the victim or the criminal and they do not give their permission either. Psionics makes it easier. We merely set up the machine for a contact rate for the individual, sit back, relax and with some small practice see, hear and taste, etc. everything he does.

The uses for such a technique are obvious. Let us say that you want to play with a certain submissive, but she has a dom and the relationship is not likely to end soon. So all you need a witness of the dom if you do not know him, (if you do, his name written on a piece of paper will work just fine) and your radionic box and helmet.

But first you have to learn how to do this. You will need a practice dummy who is talkative and has no idea what you are into. Write the target's name on a piece of paper and set up a contact rate for him. Put on the helmet and blank out your mind as much as possible by focusing your inner gaze on the center of your forehead. Start noticing the impressions that you get, looking out the eyes of the target. They will not be very clear at first but with practice you will be able to see everything that he sees. When you are with this person, subtly bring up things in the conversation that will get him talking about what you have seen and find out if what he says goes along with what you have experienced through him.

Work at this for some time. When you get the level of accuracy and clarity you want, go for hearing. This may be a bit more difficult but there is a way to make it work faster. You will need a source of white noise and headphones, old tape recorders did this just fine and there are computer programs available that create it as well. Put the headphones on under the helmet and let the noise create a void for your mind to fill from the target.

Repeat this with the other senses. I know that it is time consuming to learn this, but believe me, it is worth it!

I'm not a great fan of voyeurism. I think that for the most part watchers are no good doers. But watching is the best way to learn a new technique and using remote viewing, or perhaps we would better call it remote presence as we are doing more than just viewing, one can develop all manner of skills simply by being, for all practical purposes, in the body of the person using them. And you get to play with some really beautiful women who may not even be in the same country!

You can imagine what this can lead to. Instead of having to go out into the winter's snow, you can sit in your recliner, hook yourself into a radionic system and play to your heart's content. And you can experience doing things so totally anti-social that if you did them yourself in your physical body you would get into real trouble if you got caught to say nothing of the mess involved in cleaning up afterwards.

Huh?

Ok, everyone likes a good, non-consensual snuff scene. At least every honest person does. That is why stories of ghastly murders get so much media attention. It is not just the good mystery of finding the culprit but the vicarious thrill of being the culprit! The reason Hitler material is such a perennial best-seller is because people want to BE Hitler. Of course they would never admit it, but that is the truth.

Now, you have to remember, what we are doing here is not limited by space or time. We can go back in time and experience things with little trouble once we have the basic skills down. And as serial killers have this really bad habit of getting caught... Well you can see where this is going.

As soon as a serial killer is caught, his picture is scattered to the four winds. You can find pictures of them everywhere. These pictures make excellent witness samples. And the news stories usually have the dates of the killings as well so you know when to go back to.

Ok, you have the killer's witness and the date of the killing. Set up your machine with the witness, put on the helmet and go back in time to the murder you want was performed, because, and this is important lest you get squeamish, when you are in total remote presence, you are as much a part of the killing as the killer.

We don't have to go into details here.

But what do you gain from this besides the knowledge that you have just done something that is really forbidden but great fun? Well, you can learn something seriously important from serial killers--pick-up techniques.

People's hair really stands on end when I tell this story, but when I was a freshman in college the book about the Boston Strangler came out and I studied it. There was a lot of bondage in the murders (and I can just hear our wimpy BDSM brethren if that happened now as they shit bricks all over the internet and the NCSF puts out a panicked press release that no one will read anyway) and he had a way to pick up women that was amazing. Serial killers have a talent for getting victims to go with them willingly. That is how they get them. So if you get into the mind of a serial killer, quite literally in our case, you can take acquire the necessary skill to get your more lucky victims.

Now, at this point, I know there are some of you out there who do not quite get it and think that this technique can be of great aid to law-enforcement. That is not a good idea. First, it is giving aid and comfort to the enemy. But seriously, unless you are a real long distance from where the murder took place and have a very good alibi, you may very well find yourself the prime suspect in the killing.

Look at it from their point of view. Someone comes into the precinct with detailed information about an unsolved murder, information that they know, the killer knows and no one else does, and starts telling them that stuff. What are they going to think?

This really happened some years ago in Illinois. A bible college student in Oak Park, Illinois had a dream of a murder and it was so vivid that the damned fool went to the police. After all, he was a student at a bible college so what would you expect? Intelligence? Well, they assumed that he was making a confession and he ended up not only being the prime suspect, but convicted of the killing! His family was ultimately able to get him exonerated but you may not be that lucky.

I always tell my students the same thing. If you get information about a crime from your psionic work, keep your mouth shut. You may think that you are being a good citizen but the constabulary may view your actions in an entirely different light.

IX

Remote control

You just knew I was going to call this section that didn't you? There is something appealing about having a little box with buttons on it and being able to push them and make people do things they don't want to do, like give you money, that is very appealing, but this chapter is not about that. For one thing, it is really difficult to do and second, this is not a book about relieving people of their extra money, laudable though that goal may be. This is a section about possession and how to do it.

(Odd rumbling noises in the background.)

Pazuzu! Stop that! I know you were in the movie but I'm the one writing the book!

The things I go through! Everyone wants to get a word in, even my pet demons!

Anyway, where was I? Oh yes.

I started playing with this idea over 40 years ago now. I had just gotten myself into the idea of astral projection and had this strange notion that it might be possible to project myself into people's minds and make them do things, to take control of their bodies for a time. It was great fun and did not work real well because I simply did not have the experience to make it work. So that become one of those bright ideas that just sort of get filed away and forgotten.

Then I got into psionics.

Psionics changes things. It makes things happen that normally should not happen. And one of the things that should not happen, but does, is that you can literally, with practice, take over the body of someone.

Now, this takes work, lots of work and most of the time you are not going to be able to totally control the person because you would have to override his own mind to a degree that is simply not doable unless you are dealing with someone in pretty bad shape. But what you can do is influence the person to do things that he is already inclined to do, by simply giving him a little push.

The beginning exercise for this is pretty simple. You do not even need a radionic box, only yourself and an unsuspecting victim. Choose a victim that you spend time with along with other people. While the group of you are chatting, focus your mind on your mark and put words in his mouth. It works. It really does! And there is that wonderful moment when he says something totally out of character and looks around with a terribly puzzled look on his face wondering, "Why did I say that?"

Once you get used to doing that it is time to have fun.

I love to pick on politicians. They have it coming, being nothing but filth and pond scum. And politicians like to talk, and talk, and talk and while most of the time it is prepared stuff that they cannot deviate from even if they had the brains to, occasionally they will find themselves without a script, live, on television. That is when you can take pleasure at their discomfort, which is only right and proper as you will be causing it.

This is where the headlamp will come in handy. For years I would use a hand-held flashlight for this and my arm would get tired and screw up my concentration. The headlamp removes this problem. All you need to do is wear it and turn it on. With the politician on television, focus the beam on him and listen to him for a few seconds so you will be able to tell the moment of weakness. At the appropriate moment, fire something really stupid sounding into his head and hear the words come out as he manages to jam both feet squarely in his mouth and then spends the rest of the interview trying to talk his way out of it.

How does this particular skill play into BDSM? I'm glad you asked. One of the banes of our hobby, among many, is the fact that we have become a people of words. We talk, we talk, we talk. We spend so much time talking that we wonder if we are ever going to get around to beating butt which is why we are here in the first place!

It's annoying as hell!

And the people who do the most talking are the ones who have nothing to say worth listening to, like Guy Baldwin. (You knew I was going to put him in.) So if you have spent any time among the "community" you know what a Tower of Babble it has become. At least once a month, just about everywhere, there is some group sitting around discussing something that they have discussed to death over the last 20 years but people put up with it because they can't find a way out of it so they sit around listening to the pontificating of some imbecile who's real knowledge of bdsm would not fill the condom of a flea. We call such people "event presenters."

Well, you can use this for a good laugh.

Bdsm speakers are, for the most part, not rocket scientists even though they would like to think so. Basically they are out for a free lunch and a chance to feel superior to their audience. These people really think that because they have a website and they go around to events and talk that they somehow actually matter. I write books on mind control and I don't make that mistake!

So given the amount of hot air that inflates their precious egos, it is a good idea to stick a pin in them and watch them deflate like the windbags that they are.

The key to this is timing. Their talks are like politician's speeches--canned. They have their script and they are not likely to deviate from it if only because that would require thought. But after the talk comes the question and answer session and there they are vulnerable.

So think of something really stupid for the person to say. Now, I know that can be difficult because most likely **everything** the person says is going to be stupid, but some things are more moronic than others. Wait until the right question is asked and then let her have it! If all goes well, she will say something she never expected to say, would actually never think of saying and be so flustered that the rest of the session will just sort of fall apart. And if you combine this with a blast of energy to her forehead to give her a splitting headache at the same time... well, you can figure it out.

You do not even have to be at the event or a meeting to do this. All you need is the witness of the person and the place and time that the person will be speaking, or even be at a meeting. At the appropriate time, set up the radionic box and helmet, and use the person as a beacon, only this time you are going to be the person, rather than just looking through him. In essence, he is going to be two people at the same time.

For the most part, just sit back and watch, like you normally would, but at the right point, start putting words in his mouth. This will take some practice and they will not all come out, but enough of them will to make the person look like an even bigger fool than he already is. You can totally destroy a person with this and being the good sadist that you are, I'm sure you have a list of people that you would like to destroy.

And here you see one of the reasons why psionics folks do not worry about interference from politicians. If you can get into the head of a political figure, you can pretty much make his career dust. In practical terms, if some poor local politician decides that he does not like the local BDSM community it is a relatively simple matter to cause him to make such a total fool of himself that no one in town will take him, or anything that he says, seriously. And it is an equally simple matter to put the idea into the mind of the local Federal Attorney that maybe this politician should be looked into for some reason or other.

Faced with a crusading cop or district attorney? Nothing simpler. They make all kinds of enemies in their work. Find one and get him mad enough to go out with a gun and do your work for you. The target is destroyed, as my Russian opponents used to say, and you cannot be touched.

So work on control. And we will dominate the world and not worry overmuch about getting its consent first.

Now, there is a very old technique that was used a lot about a hundred years ago and then sort of disappeared but is very effective. In essence you do long-range hypnosis and a Russian psychologist, V. V. Vasiliev, developed a technique to make it work very effectively. His method had only one serious drawback. It required the subject to be hypnotized by the operator first in the conventional way and then given a post-hypnotic suggestion that he would respond to what was sent to him by the mesmerist. As you can imagine, this set up an interesting roadblock because you had to have the subject first willing to be hypnotized, or be really good at disguised hypnosis.

With psionics we can get around that problem.

What we will do is combine the Vasilieve technique with a method used for distant healing and influence along with our machines.

Let us say that you really want to play with a certain person but she is a social butterfly and just getting onto her dance card is almost impossible. In this case, you know the person so you do not need a witness sample. Her name, written on a piece of paper, is sufficient for this.

First you need to find out when she is likely to sleeping. That is when she is going to be most open to your transmissions and you do that by asking the pendulum to tell you. The pendulum can tell time in a number of ways, from holding it over a clock face to holding it next to a wall and letting it bang the hours, so if the subject is going to be asleep at 2 AM, it would bang twice.

The next time you encounter her, send a thought message to her, as you would do in putting words in her mouth, that at the appointed time she will be totally open to anything your mind sends to her and that cannot resist it in any way. Send that message in short bursts as often as possible and know that it is getting into her subconscious priming her for what is coming next.

As the time of working approaches, you set up the box to a contact rate for her. You do this by putting her name in the witness can and then taking a rate, then plugging in the helmet.

You put the helmet on and remote view her sleeping.

Now you start to talk to her. You can do this out loud if you want.

You speak to her in a calm, commanding voice, telling her that she knows how good a player you are and how experienced you are and that she knows that you can do really interesting things to her body and mind and she wants to play with you. She REALLY wants to play with you. She cannot get the idea of playing with you out of her mind. Every evening at 10 PM she will have an uncontrollable desire to play with you.

You get the idea. By putting a specific time in you anchor the thought. She will see the time, it is the time she puts on the news to get the next day's weather, and your command will kick in in her subconscious getting her all wet at the thought of you.

Keep this up and it will be a very short time before she asks YOU to play with her.

This is also a very effective weapon to use in scene conflicts.

Scene wars are not pretty. They are, in fact, downright nasty because scene people are not nice. If you get involved in one, you cannot be nice either.

So let us say that some annoying bitch has decided that you are a bad person and attacks you in a chatroom. People are always attacking other people in a chatroom. If that happens, do not debate with her, do not argue with her, do not waste any time defending yourself.

Destroy her!

How do you do this? Very simply. Follow the above procedure and in this case tell her that she is utterly worthless, everyone hates her, everyone laughs at her and that you are laughing at her.

Just keep pouring it on how utterly useless a human being she is, that she is no better than a coal miner's daughter in some trailer park (and if she really is a coal miner's daughter in a trailer park so much the better), that she is the scum of the earth.

That is stage one.

Stage two is determining who she hangs out with. Do the same thing with them only in this case get them to believe that she is the scum of the earth.

After all, it is only the truth.

After a short time of this, you can go your merry way and watch the fun as she sputters and fumes and stamps her silly little feetsies and no one cares what she says or thinks about anything.

And now we get to the genuinely evil stuff so hang onto your hair!

Let us say that you are at a party and it gets busted. I know, the odds of that are about the same as winning the Powerball jackpot, but for the benefit of my readers who actually worry about such things, let us say it happens.

While it is going on, do not bluster or do any dumb dom things. Follow the rules but while following the rules put the idea into the heads of the cops that they are going to be open to anything you send them.

And when you are able to, send them death.

Lock the images of their faces in your memory because your memory is going to serve as the witness sample. You will have their names as well.

Follow the standard procedure to find out when each one is vulnerable and transmit to each one that his heart will stop at a certain time a couple of weeks hence. Psychically inform each one that he is going to die, that there is nothing that can prevent it, that his body is tired and his heart is not going to last much longer. Then give him a date to die on.

In between doing that, set up the box for a contact rate for his heart and visualize it stopping and dying. See the blood flow stop, see the heart slow and become inert.

Do this to every cop involved in the raid. None of them will live to the court date and the case will have to be thrown out.

After you have done that, create a thoughtform in the local police station to say to the survivors wondering what the hell happened to their donut buddies, "Don't even think of pulling a dumb stunt like that again!"

Remember, we are people who torture people for the fun of it. We are not the kind of people they want mad at them, especially since we can do them in and they have no defense.

There is one more technique to cover in this section and that is dream invasion.

Dream invasion can be a thoroughly evil bit of entertainment because you can cause your subject to squirt in the sheets or have such nightmares that she will be terrified to go to sleep for fear of what dreams may come.

In any event, the basic requirement for this is that your victim be sleeping! It does not work very well when she is awake.

Set up the box and helmet with a contact rate for your victim. That is the easy part. The hard part is finding out when she is dreaming because dreams are relatively short things and come at different times during the sleep cycle. For that you will need your pendulum. Put on the helmet, hold the pendulum where it can swing and hit something and ask it first for the hour when she will be in dream state. Next ask it for the minutes. That is very important because you need to be exact in this.

At the appointed time, put yourself into remote presence in the mind of your target. You should find yourself squack in the middle of her dream. This can be a very weird experience because you never quite know what it is you are going to be landing in. But look at the bright side, neither does she!

Once you get your bearings, it is time to go to work. Begin manipulating her dream, putting ideas and images into it. Think of it as building a computer game in 3D. With a little practice you will be amazed at how easy this becomes.

A good one is to change your features so that she cannot recognize you and chase her all over the place with obvious malefic intent. You can give someone a real workout this way and be a real, genuine night terrorist. One of the best ways to do this is to do some homework before the invasion and practice seeing yourself as you intend to in her dream. Have you ever wanted to be the Mad Rapist? Well, now you can. Her experience will be of a masked figure chasing her down twisting, dark, narrow alleys and finally being dragged into a basement and raped. It will not be pleasant for her but it will be fun for you and it will set her up for stage two.

Stage two is you as you, in a benevolent form, filling the air with light and joy. Ok, this is out of character but believe me, it works. After the horrific experiences she has been having, you are going to be a welcome relief and when she spreads her legs this time it will be because she wants to. And she will want to because you will be broadcasting into her mind that she does want to, that she cannot resist the desire.

Now, what is the purpose of this exercise? It is to destroy the will at the subconscious level and program her to see you as desirable at the conscious.

There are some writers on this who suggest taking the form of the present boyfriend at the first stage. I do not. I think that that is a waste of energy. Yes, done right it can turn her away from him, but if you do both stages properly, he will become irrelevant and she will gladly leave him for you.

This is a good technique when used to convert someone who is, for all outward appearances and experience, vanilla. Now, as we all know, the vanilla are God's mistake and we are here to correct that mistake so you will, of course, be not only doing her a service, but the will of God. (How can he say this? Because he IS the Kwisatch Haderach!)

CHUCKIE!!!

Ok, all kidding aside, there are a lot of attractive women out there just waiting to be flogged, but for some reason they have just not met the right dom and they are stuck in boring, vanilla, relationships and for some bizarre reason do not realize that they should be your submissive. I know, that is difficult to understand given the media attention we noble perverts get, but it is the horrible truth. They need help!

So you find a target who just gets your dick hard thinking about her, and the pervometer reads all sorts of nice, fun things, but for some reason your remote viewing does not give any indication of them being done. This has to be fixed. You cannot in conscience let this poor dear go through life being frustrated and bored. You need to get into her dreams and get her hot for you and your toy collection.

This is where the pervometer really comes in handy. You will need to know what to make her dream about, in particular dream about you doing to her. Before even deciding on the scenario, use the pervometer again to determine her desires and then sit down and write down different techniques for each of the basic ones. For example, bondage, what does she fantasize about? What position, what binding tools? Go through the list and get it down as detailed as possible and by using the pendulum find out what will get her the hottest the fastest, because in dreams you do not get a lot of time.

Once you have all that down, do the dreamwork and work on her, bringing her to orgasm in the process. Keep this up until you are able to get her into the dungeon for real. She will be eternally grateful to you.

Now, there is one other method to consider here and that is dream blasting on a large scale. About a year or so ago I came up with something that I called the Cthulhu Project. For those of you not up on your Lovecraft (shame on you), Cthulhu was the peculiarly constructed priest of the Old Ones who sleeps under the sea and his dreams project madness to the world.

I decided that it would be fun to project horror and madness to the world, so I had a bunch of folks sit up late at night and watch slasher movies while hooked into a radionic box and helmet with the witness of the earth as the target. The idea was send nightmares to as many people as possible, just for the evil fun of it. This technique can be used to demonstrate the utter, total futility of attempts at censorship. You see people who believe in censorship have this peculiarly weird idea that they somehow can control the flow of ideas and images in spite off all evidence to the contrary and because they are vile, despicable, disgusting folk who usually go to church, it is a good thing to make them frustrated. That being said, how do we go about this? The same way as the Cthulhu Project, except in this case we aim for a more limited geographic target, a city, for example, or maybe a small town.

You begin by acquiring a bdsm porno video of some kind. Or you can watch them streaming online if you have the right accounts to the appropriate websites. Once you have done that, go online and get a satellite image of the target area. Print this at the size convenient for your instrument and then cut it out.

Set your box to the contact rate for the target area.

Plug the helmet into the box.

At the appointed hour, sometime around 3 to 4 AM target time seems to be best, put on the helmet and turn on the video or the video stream. Then all that you need to do is watch the video. The machine will do the rest and everything that you see will pour into the helpless subconsciouses of the people sleeping in the target zone.

Now, think about what this means. Politicians from the Bible Belt may get their panties in a knot (they are mostly closet drag queens and pedophiles anyway) about all that terrible, horrible, godless porn out there but now there is not a blessed thing that they can do to stop it. It is being fired directly into the empty heads of their constituents while they are sleeping and the forces of sin and corruption are winning!

There is no idea that cannot be spread this way. You simply pick the right movie and send it. For example, if one of your people finds himself on trial for killing his sub, (accidents do happen) simply broadcast the movie Twelve Angry Men at the jurors while they are sleeping and he will be acquitted no matter what the evidence. The jurors will simply not believe it!

And think of this! When the religious nuts out there start whining about THE CHILDREN, their children will be dreaming that night about naked people being tortured!

Censor that--assholes!

I just sort of like this picture

It reminds me of me.



X

More Thoughtform Work

Now that we have the basics down, it is time for some serious fun.

Sabotage is cool but you can do more with thoughtforms than ruin somebody's day. Let us say that you have a play space that you frequent pretty regularly and you are in a play partner desert. This happens to all of us and it can be damned frustrating to just sit and wait while other people are happily beating their victims. Now, you can set up your machine at home and use remote presence but that is not always the most satisfying method or you can set up an attractive thoughtform to bring the right victim to you.

In essence you are going to be creating a psychic land mine that you will put over the door of the play space and program it to bring the right play partner to you.

This is very easy to do. All you need to is put yourself into remote presence in the play space and you can do that at any time. After all, it is not like you need someone to unlock the door and let you in. Once you are there, see the door and begin to make the thoughtform right over it. I like to create it in the shape of a lamp of some kind and program it to beam down on the doorway itself, charging it to bring you the type of person you are looking to play with.

Make a pattern for this thoughtform and use that to contact it and keep its charge up because the charge will go down and sometimes it may take a few weeks to get the right person in the right place at the right time, especially if the play space in question is couple's oriented and single targets are relatively few and immediately set upon by so many singles that they are never seen nor heard from again. Do not be a part of that sort of thing. At the most, introduce yourself and sit back down. When the thoughtform brings the right person, she will come to you.

But let us say that you have met someone who seems interesting and the pervometer says that your desires are reasonably compatible. Now you need to get her to your dungeon and under your ropes.

First, do your homework and find out if there is anything or anyone already in the way. Remember the story of my little experiment. You do not want to wait eight years. If that is clear, your next move is to create a thoughtform that will draw her to you and make her want to be drawn to you. It is not like she is going to get much choice in this matter.

Create the thoughtform in some simple form, a ball works just fine, and program it to draw her into your control. Make a pattern for the thoughtform and then when you contact it, experience in your head what you want to do with her, so if you are going to be tying her up, actually feel working the rope around her and knotting it. If the pervometer is correct, she will respond subconsciously to everything that you do to her

and when she see you that subconscious will kick in and she will find that she wants to play with you.

Now, at this point I have to put in a serious proviso. Do not jump the gun. If you go in for the kill too quickly, you may cause her to react in the opposite way of what you want. Just sit back, relax and let the thoughtform work. If you are doing your job right, even if she seems to be getting involved with somebody else, she will find herself with you. And do not obsess. Even if you want her so bad that you can taste it, keep yourself busy with other things and let nature take its course. It will.

And remember this. Compatibility on the play floor does not mean compatibility for life. If you are contemplating a long-term relationship, there had better be a lot more than BDSM or it will not last. You can save yourself a lot of trouble if you remember that. And it does not have to be someone with everything in common with you either. The most disastrous affair of my life was a short fling with someone with whom I had nearly everything in common.

From getting a play partner to protecting the play space may seem a bit of a leap, but it is another thing that thoughtforms are just made for. Play space owners are not into psionics and thus find that they worry about all sorts of legal things that they could just avoid with a few simple techniques. Well, there is nothing that says that we cannot do that for them and protective thoughtforms are just made for such things--quite literally.

The best way to do this is to make a thoughtform and place it in front of the entrance to the building that the play space is in. Choose a shape that is pleasing, such as a shield, and program it to keep the enemy away AT ANY COST TO THEM. This last is important. You cannot be afford to be squeamish in such matters. If protecting the play space means that a couple of vice cops have to die, they are no loss to anyone anyway, with the possible exception of the local donut merchant. What will happen is that as soon as they get the idea of busting the play space, something will happen to them, something nasty that will keep them so occupied that they will not be able to do anything to anyone.

Build this thoughtform, pick a name for it and make a pattern to contact it with and keep giving it regular chargings. Each time you charge it, be sure to repeat the instruction and each time you go to the play space give it an extra boost as you walk in.

From protecting the play space to protecting the local scene in general thoughtforms are the best tools you can use short of direct psychic action. Every once in a while some self-righteous old biddy will try to interfere with your people and she is easily dealt with.

Using remote presence, create a thoughtform around her like a black cloud that will engulf and devour her. Program this thoughtform with the command to "Bring unspeakable horror to X." Unspeakable horror is usually fun and is open ended enough that it can cause all manner of things to happen, ranging from pancreatic cancer to her child being run over by a garbage truck. After all, there are far worse

things that can happen to a kid than having a bdsm group in the community. If the problem with our people is their lack of ruthlessness in dealing with the gadje, then this method is the cure.

Let it be upon their own heads.

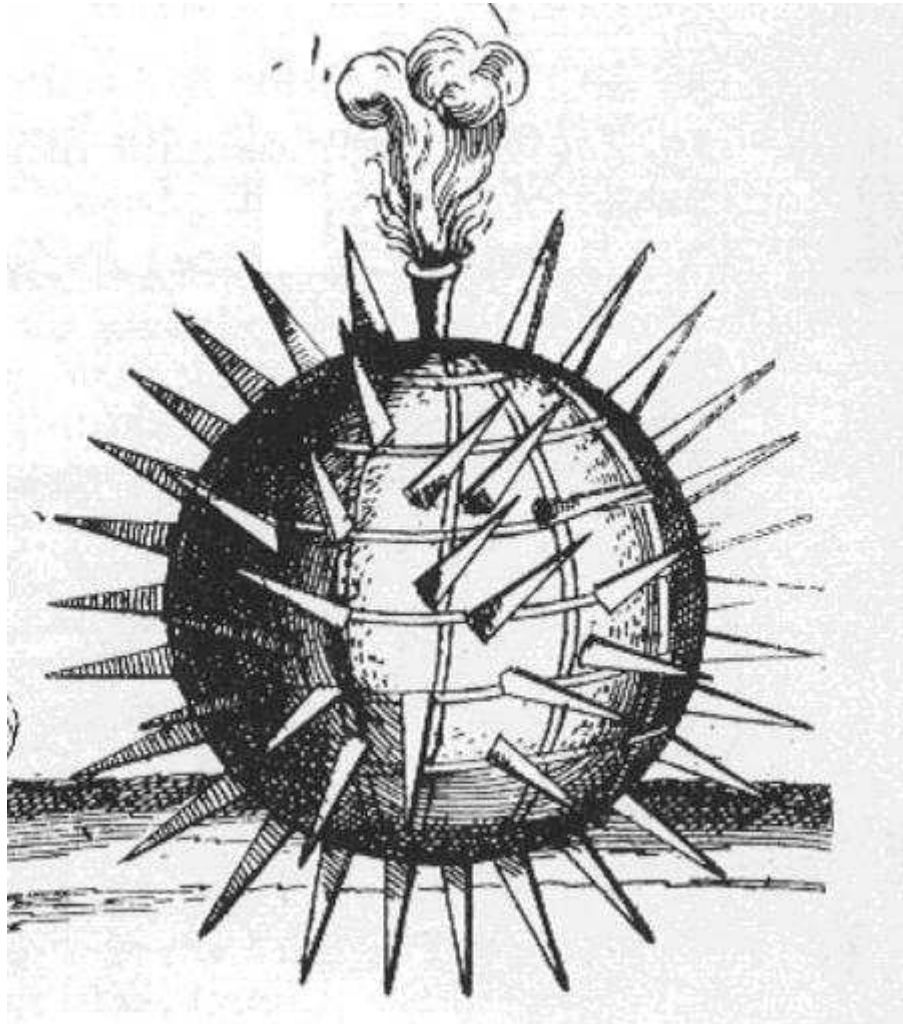

This is a good model of an aggressive thoughtform.

XI

Play Energy

This is something that requires a special chapter because it involves a real peculiarity of what we do. It is something that I first encountered in a book many years ago and for the life of me I cannot remember where and it is something that I have worked with and elaborated on for some years now.

The reference in the book was a very brief one about Chinese sorcerers torturing women to steal their chi. At the time I thought that it was pretty silly, the sort of nonsense the Sages would get into along with giving the First Emperor mercury pills and powdered jade to make him immortal. In other words, these are not the sort of people you take too seriously once you get to know them. And thus, in spite of my magickal interests, I just laughed at the idea and forgot it.

Until someone gave me a copy of Patrick Flanagan's *Pyramid Power*.

In that book he describes Russian experiments in which they discovered that painful stimulus would cause a measurable expansion of the electromagnetic field around the human body. You can actually prove this. Get an EMF meter and set it about four feet from your submissive. Now, give her a good whack with a paddle on her rear and watch the needle jump. It is really quite amazing when you see it happen for the first time.

From that I formulated an idea about what us sadists get out of play. After all, everyone knows what the bottoms get. They get the physical stimulus, the endorphins (which are actually a myth. When I was in the hospital I learned that nothing happened to get rid of pain except plenteous medication.) and the attention. But what do we get? We do all the work and there is no direct connection between what we do and the reaction of our bodies. Well, there is.

When you inflict pain, the expanded energy field of your victim interacts with your own field, causing that field to send information into your subconscious. And at the subliminal level you get your jollies from that interchange of energy. When you add that to the conscious joy you just naturally feel at the suffering of a fellow human being, you can get one hell of a rush. After all, true joy is only found in the sufferings of others.

So there is something to the ancient Chinese magicians after all, but I don't think I'm going to be taking mercury pills any time in the near future.

But there is another interesting feature to this expansion of the human energy field and that is that it knocks the notion of consent into the dustbin where it belongs along with Marxism and Guy Baldwin. And this is based on serious, academic research by a

serious academic researcher who is also famous--Dr. Charles Tart of the University of California at Davis.

Dr. Tart decided to do a little experiment. He hooked a test subject into a polygraph and had him just sort of sit there. A couple of rooms down the hall, Dr. Tart gave himself a series of electric shocks to his ankle. Obviously there was a shortage of masochists in his circle. Anyway, the polygraph showed a marked jump at the same time that he gave himself the shocks. The subject had no way of knowing what was causing the response, in fact did not even know that the response was even occurring. What was happening was that the subject was responding to the stimulus applied to Dr. Tart at the subconscious level.

Now what has this got to do with us, and with consent?

When you play, when you inflict pain upon your victim, the energy field of your bottom is expanding and at the same time transmits information which is picked up by the subconscious mind of everyone in its path. And we have absolutely NO idea how far that information carries. It could very well go around the world and out into space for all we know! But we can be absolutely certain that is blasting into the minds of people whether they want it to or not. Unless they work to protect themselves, there is no natural force stopping them from getting this stuff.

When you flog your sub, you flog the world.

So now think of the dungeon, or even your bedroom, as a broadcasting station and from that station you are sending out waves of information to all humanity. Except for the hopelessly vanilla, who suffer from a genetic defect which prevents them from accessing this in the same way that the blind cannot access light, everyone, literally everyone, is being hit and is at some subconscious level responding.

And this explains how we get into this in the first place.

People have been torturing other people for thousands of years. It is one of humanity's oldest sports and these waves have been bouncing around for that long. Everyone gets hit with them from the moment of birth and those of us with our more evolved central nervous systems come to respond to the stimulus at an early age. It burns its way into us and by the time of sexual awakening we know, beyond a shadow of a doubt, that it is cool to be cruel. And if we avoid the rocks of social disapproval forcing these desires into quiescence or uncontrolled behavior that gets us into terrible trouble, we become good sadists and get to have our fun at the expense of suffering humanity.

And we can use this fact to cause all manner of trouble for those who do not like us, which will give us double pleasure.

To do this, you need to set up a play area as an energy collector. This is done by laying down a large sheet of mylar, big enough for a piece of dungeon furniture, such as a cross or spanking bench, to be stood upon it along with your submissive. The

mylar is then attached to the patch cable that you use with the helmet/lantern arrangement and plugged into your radionic box.

Once you have done that, you take a photograph of the church that the old biddy who is causing problems for your group attends. You set up a contact rate for that church.

Do you see where this is going?

Tie your submissive the cross and torture her as you normally do. What will happen is the energy that she is putting out will be picked up by the mylar as a witness plate, run into the box and thence to the church building where it will attack everyone inside.

If you wish to be even more creative, place a thoughtform into the church using remote presence that will concentrate and fire the energy that is being sent while the services are going on. Get that thing really charged up and the spirit will be moving!

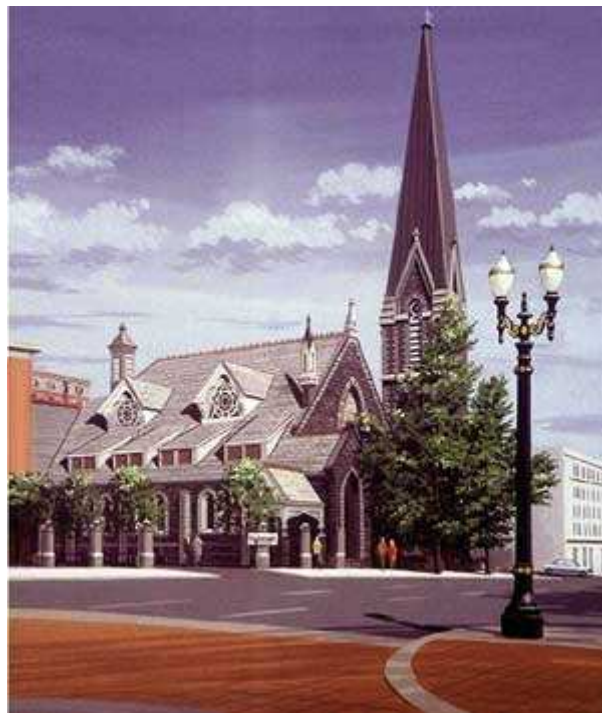

Here is the church, here is the bell. Build the thoughtform, blast the people to hell.

The funny thing about this one is that I did not invent the idea. It was actually created by someone who wrote a satire of me about ten years ago which purported to be a lecture that I had given to a group of magicians about dealing with the Christian menace. It clearly was written by someone who knew me and this idea was so good that I decided to actually use it.

Now, there is an even easier method which works perfectly for sending the energies of public play booming out to the target. Public play spaces sometimes have a problem with people moving their furniture to put large, mylar sheets under them. Why this is is

one of the greater mysteries but it is nevertheless a fact that we must deal with. Fortunately, your Uncle Chuckie, in his infinite wisdom and with perfect malice in his heart, has created a very simple way to work around this.

All you need is a witness of your victim for the evening and a photograph of the target and a radionic box. In this case, let us use the target that I used literally the night before this writing, an outer-space picture of the Earth.



Before you go out, you set up the machine with the witness of your victim in the transmission side of the machine and take a rate. Place the picture of the Earth on the stick pad, which in this case will function as the receiver plate. Now, everything that your bottom experiences is going to go booming out into the field of the Earth itself, infecting the subconscious of every man, woman and child on the planet. No one can escape your influence but of course the effect will differ with every individual.

What that means, and you must remember this, is that when you perform this action you are not playing only with your partner. You are quite literally playing with the entire world.

Now, this method can be done to target specific individuals as well. Let us say that you have a nice play space and for some reason or other some xtian bitch gets it into her head that it is not a good thing to have something like that in town. Well, all you need is a witness of her and your radionic box.

Put the witness of your submissive into the transmittal side of the box and the target witness into the receiver side. Play with your submissive--hard! Make sure that the marks last for at least a couple of weeks. And everything that you do to your submissive you will be doing to the target. With any luck, and this has actually been known to happen, the target will even have marks appear on her body where you put them on your submissive. You can just imagine the reaction to that! You will, at the

very least, drive her insane and with any luck and the mysterious marks on her body will make her run to the doctor, who will see them and automatically assume that they were put there by her husband. Being a mandated reporter, he will turn the husband in to the constabulary who will take him off to durance vile to the collective laughter of the media who will have a field day at the expense of the poor fools. After all, they can hardly claim that it was consensual S/M play after making all the public fuss against it. Besides, it was not consensual in any event. When you combine this technique with the thoughtform defense you have already created they will not know what hit them.

There is one final method to be discussed here and that is taking the play energy of the entire dungeon and transmitting it. This can be done in two ways. The easiest, if you are able to acquire it, is to take a photograph of the dungeon (it does not have to have play going on it in when the photo is taken) and put that in the transmittal side of the radionic box. The other is to create a thoughtform to grab the energy out of the dungeon, make a pattern for that thoughtform and use that as a transmittal witness, again placed in the transmittal side of the instrument.

Now, let us go back to blasting churches. There is one day out of the year when we can make all manner of lemonade out of those lemons and that day is Good Friday! For lots of Xtians, Good Friday is a grand festival of sublimated sadomasochism celebrating the torture and execution of Jesus (who deserved it!). And the more they get into it the more fun we can have because the door is wide open!

So you will need to do something just a bit different. In this case, you set up the machine with a witness of yourself and a witness of a local church that you know is going to have a late, Good Friday service and choose a church that is likely to have a congregation that really gets into it, like a Latin mass Roman Catholic one. They make the best targets.

Tie your bottom to a cross, a T cross is best but if you must make do with a St. Andrew's, oh well, it will still work. Then do a heavy flogging scene. Make this one a blood sport if you can. Now, while you are doing this you are going to probably get seriously turned on in any number of ways. Imagine all this being fired at that poor congregation! Those people are never going to be the same.



used with permission

You get the idea.

You see it works like this. Inside the bulk of humanity there is something hardwired into the nervous system to respond to this stuff. There are a few cases where it is not but they are actually a distinct minority which is why the symbolism of martyrdom works for religions. The iconography of torture would not work if it turned the congregation away so we have an opening into their heads by the very fact that they are sitting there.

When we transmit the play energy of our bottoms, we are exciting that part of the subconscious of our targets and setting them up for conversion, so to speak. Think of this as an evangelistic outreach of sorts. The church will be full of people who will feel a major stirring of the hormones in ways they have not felt since adolescence and it will puzzle them greatly.

It is great fun merely to contemplate the effect it will have on family gatherings afterwards. The poor devils will not know what hit them. Of course it might be a bit dangerous for the choirboys, but you can't make an omelette without breaking eggs.

And that leads us to the next chapter...

XII

Energy Grabbing

Or how to be a vampire for fun and profit.



No, you don't have to turn into an early jet fighter. I just happen to like old aircraft.

As I've said before, one of the things I really, truly enjoy doing is taking things that people do not approve of and then writing about how to do it. There is something very satisfying to the soul in hearing people sputter with impotence at my latest enormities. And because I have made a career out of violating norms, they have a lot of opportunity to sputter. And for some reason what are called, "energy vampires," drive the bdsm purists to distraction. Given that it was only natural that I would write about doing it and here are some more methods to accomplish that end and put the energy to work.

It should be obvious by now that play in the local dungeon puts out tons and tons of free energy which is available to anyone who has the wit to steal it. The usual procedure is unconscious. The person just sort of watches and absorbs, to the annoyance of various players who forget that when they play in public people are supposed to watch! Idiots! But that is a relatively crude method and the people who do it are working unconsciously for the most part. Nevertheless, it has the advantage of being present in the field where the energy is produced and thus one can choose which energy pattern (determined by the type of play) is most useful.

In essence, when you use this method, you set up your own energy field as a receiver and accumulator. When you go into an active dungeon, you are immediately engulfed in a field of play energy being emanated by all the participants. This is a power source

and a source of information. As a power source, it can be tapped and stored for future use. As a source of information, it can be transmitted to the unwitting and unwilling for our benefit and amusement.

You can also use the energy of other onlookers because they are putting energy out as well as taking it in.

So let us begin. When you arrive at the play space, sit down in the social area and charge up your field, instructing it to absorb the energy of the play going on in the dungeon. Do that for a minute and when play starts, go in and watch. Observe how you feel. Do you notice what you are taking in? Does it produce any response in you? Stay there for a few minutes and pull energy in. Once you have done that, leave the the dungeon area and go into the bathroom. This is so you will have some privacy for a minute--NO! Not for THAT!!! Control yourself!

(The things I have to deal with!)

When you are in the bathroom, create a thoughtform with the energy you have stolen and fire it off. This will put the energy to use and relieve you of the burden of having to hold onto it. You can use this energy for any purpose whatsoever.

So much for the simple stuff. Now you are going to create a thoughtform that will do the grabbing for you.

You do not have to be in the dungeon to do this. In fact, it probably is best that you are not because you do not want to be distracted.

Use remote presence to put your mind into the dungeon area from your home, like you would if you were going to use remote presence to play there through someone else. Select a spot near the ceiling of the dungeon, preferably centered as much as you can between the various stations. Once you have done that, build a psychic vacuum cleaner. It does not have to look like one, though that would be fun if you can do it, but it will function like one in that it will suck the play energy up out of the space and store it for you. Give it a name and make a contact pattern for it so you can tap into it whenever you need to.



Ok, I'm being silly here.

Now you have a lot of play energy, with all the information and experience of the people playing and watching in the dungeon. This is potent stuff and the Pope is coming to town!

Oh boy, this is going to be fun.

He has a special gathering planned for "Youth." Can you say "Hormones?" And how does the Pope make a whole moan? By not paying her, of course! All right, I have to get serious now.

True pleasure is only found in the infliction of pain and the corruption of the innocent and the innocents are going to get corrupted.

You get a photograph of the location where the gathering is to take place. That should be pretty easy because it will be all over the local media. You have the contact pattern for the thoughtform. Set up the contact rate for the thoughtform and then put the photo on the output. Let fly!

What you are doing is charging up the energy field of the target area so that when the crowds of superstitious young come into it they will get hit right in the gonads by the play energy from the dungeon. So you will have thousands of college age people, in the full bloom of youth and sexual excitement, crushed among each other and their subconscious minds are getting blasted by your thoughtform. The effect should be nothing short of nuclear. The gathering will probably not turn into an orgy, they will have too much socialization to overcome for that, but when the opportunity to give into temptation comes, they will not be found lacking in zeal.

The same principal applies to Evangelical gatherings as well and if they are Pentecostal...well, you understand the concept. The energy is present and as soon as the social guards come down the juices flow and mingle. And a goodly number of them

will add BDSM to the mix and when they get old enough to join the groups we will reap what we have sown. They will be the whirlwind that we will send flying into the culture.

There is one more method of energy gathering which works in a delightfully non-consensual way. You can gather energy from anyone who shows a particular interest in looking at anything. Remember the eye-beam? Well, you can use the eye-beam of another person to suck energy out of them. All you need is something to attract their attention and an accumulator.

There are a number of methods of doing this but a favorite of mine when I was younger was to use people in an art gallery. I was part owner of one and it was a simple matter to place a small work of art that would act as the accumulator, put a thoughtform in it to do the grabbing and then let people stare at it. But there was another thing I did that was much more fun.

I had a very tall submissive, I was into very tall women being somewhat short, and one night I put her into a tight crotch rope under her clothes, hung a crystal around her neck to act as the accumulator and put a locking harness gag on her. Then we went into the gallery. It was, of course, one hell of a fashion statement, a performance work entitled, "Vow of Silence."

And, as you can imagine, even in the environment of a gallery that specialized in somewhat out of the ordinary even by art world standards material it got quite a few shocked stares and if I had not been one of the owners we might have found ourselves seriously unwelcome. But as it was, we were just part of the art. And as the people stared at my submissive and the height contrast between us, the crystal at her neck pulled in the energy from their eyes.

Now, you may wonder why the crotch strap under her clothes. The answer lies in projection. As she was sexually stimulated, the people around us unconsciously picked up on that and equally unconsciously responded, adding more energy to what they were already putting out and putting a distinct sexual tinge to that energy that might not necessarily have been there otherwise.

When we got home later that night I removed the crystal from the necklace mounting and stored it as a power cartridge for some time when it might be needed.

So as you can see the possibilities associated with this sort of thing are limited only by the imagination. For example, you place a similar crystal on your bottom and then torture her in the local dungeon with an audience. As the folks look on drooling, all that energy they are putting out will be yours to do with as you see fit. If your submissive is attractive enough, simply having her naked and in some form of bondage will be more than sufficient. But she must be attractive for this work and be honest about this. You want lust energy, not revulsion and let us be honest, just because she may be beautiful to you does not mean that she is beautiful to everyone else. Not all of us are blessed with perfect, or even good, bodies and age does take its toll. There are few things

more tragic than a woman with the body of a teenager but the face of an old crone trying to look like a teenager.

Even with psionics there are just some things that will not work.

XIII

The Astral Leash

I got this idea many years ago reading a novel by Dion Fortune, *The Demon Lover*, and in it the sort of hero is a bit of an evil person who gets reformed by the love of a woman, a rather common plot device back in those days. Anyway, he is also a powerful magician and he gets the girl under his control and keeps her that way by putting a psychic collar and leash on her, using hypnosis and if she misbehaved, it would just kind of tighten.

Psychic breath play!

Ok, this can be fun.

And it can be even more fun if the victim does not know that you are doing it until you have already done it.

Now I know that you cannot wait to try this, so here is how you do it.

First you need a victim. She does not have to be a willing one. Remember, consent is for weenies. What is important is that she does know you and is not totally incompatible with you for the simple reason that you are going to be stuck with her. And it is important that she be someone with whom you have some contact, preferably someone you see regularly hanging out in the same dungeon. You need this because you want to see her respond to your little trick.

Set up the box and helmet for a contact rate for your target. While she is sleeping go into remote presence and begin to create a thoughtform of a collar and leash around her neck. Do this for a number of nights, making the thoughtform as strong as you can. You want her to really feel that collar around her neck in her subconscious mind. The next step is to create the leash.

You do that the same way, making a thoughtform of the leash attached to her collar and then to you. Work on this for some time as well. You want that to be as strong as the collar.

Work on this for a couple of weeks every night at least. You want this to be a very strong, powerful connection that only you can break when the time comes.

And one thing. While you are doing this, it is very important not to give any outward sign that you are. Pay no extra attention to her at all. Give no indication of any interest other than what might already be there. Be careful. You do not want to have this backfire in the early stages.

After a couple of weeks, start to yank her chain a little--literally. Test the leash to see if it is working. You do that by simply feeling your hands pulling on it drawing her to you. If it is running properly she should start to come over to you and if it is really working she should get to you without becoming distracted.

This is creating a psychic bond in the most literal meaning of the word.

This is also the dangerous stage because you do not want to become the kid turned loose in the candy store. It is very tempting to go in for the kill too early and that always results in everything blowing up in your face. Be patient. If the system is working, it will not matter who else is interested in her or whomever she may be interested in. She is collared to you only she does not know it yet.

Keep building this up. And at the same time do the other things I have described earlier to reinforce the attraction. You will have her.

Once you have her, you can use play to reinforce the bond. After all, you will have her in bondage in a much more literal sense. And this is where the energy coming off your hands gets put to work.

During the course of play, gently move your hands around her throat while visualizing the collar. Really feel that you are molding a steel collar around her neck as if you were molding the metal in your hands. If she actually has a collar on, so much the better. The movement of your hands will create a pattern in her energy field that will be very strong. No matter where she goes, she will not be able to break it and if you do your job right she will not even want to.

XIV

Play

I've touched briefly on using these techniques during actual play because up to now I've been dealing with the problem of how to get around the consent factor. But the time comes when you no longer have to worry about that. You have your victim in your dungeon, her clothes are off and it is ready to play. That is when you really get to use psionics.

So let us begin with the most basic element of play, bondage.

There is something that drives me to distraction and that is the rope expert who spends literally hours tying up his victim, takes a few pictures and then unties her! Pablo Casals had a great line that describes such people, "You are playing the notes beautifully but you are missing the music." They are forgetting a salient feature of bondage. It does more than immobilize. It changes the relationship of the mind of the victim to her environment. In a very real sense, it takes the body out of the system, allowing the mind to function in ways that it does not in normal life. It also produces a relaxation response after a time which is akin to a meditative state. This is the perfect situation for using psionics on your submissive.

The key is time. The mind requires time to adjust as does the nervous system. The longer the time the submissive spends tied, the greater the level of adjustment which means that you don't just tie her up and then immediately untie her again, not if you want to get any sort of mental response. You need at least an hour, preferably more. Two hours is a good target to aim for and three is even better.

The same is true for any type of sensory deprivation. The longer you keep her that way the more effective it is. And more thorough it is the more effective it is. One technique that works very well is to prepare her before going to the dungeon by keeping her blindfolded all day and, if possible, not removing the blindfold until you are done playing. You will be amazed at the results such priming can bring.

Now, this means that you have to pick the method and position of the bondage with that in mind. There are some positions that can become very painful after only a few minutes. That does not mean that you want to avoid those positions. Pain is an energy stimulator. It merely means that you have to be aware of that so you can decide if that is the effect that you want. And if that is what you are aiming for you cannot use safewords. The knowledge that she is going to stay that way no matter what is a good means of settling her mind, whereas if she has an out she will be constantly trying to decide if she should use it. You have to remove that process.

Which is why safewords are a real bad idea for this sort of thing.

So forget all the crap you have been told. You are aiming for something quite different.

At the same time, you want her to stay conscious and that means no total immobilization while standing. That will cause the blood to leave the brain and she will pass out on you which is a damned inconvenience and not at all conducive to the sort of the reaction you want. This means that if you have her tied standing to a post, make sure that her legs can move a little so that she will stay awake.

Another thing that you need to remember is that the position of the body will influence the flow of energy in and around the body. That is the reason for all those silly positions in hatha yoga. They are not to make the person limber, though that is a side benefit and every submissive should study yoga for that reason. They are to direct the flow of energy. This knowledge can be very useful in play. Unfortunately it is not possible to go into great detail on that as every person is constructed differently. You will have to do a lot of trial and error work to find out which positions work best for each submissive. Remember, what may get the juices flowing in one may very well dam the stream in another.

Ok, once you have her tied up you need to do some quick work on yourself. Sit back for a couple of minutes and charge yourself up. After all, it is not like she is going to be leaving any time in the near future so if she gets a little bored it really does not matter.

Let's say that you are going to start with a little flogging. That is pretty standard and most people will fall asleep watching it because everyone does it. Well, you are going to add a little something extra.

You are going to send your energy field down along the flogger so that when the falls hit they will also carry that energy into her field. This will mean that you have to use a very specific technique in order to make this work right.

If you have ever had the misfortune to actually watch how most people use a flogger, you will notice that they tend to hit with the body of the falls. That is not how you should do it for this. You need to hit with just the very tips of the falls. Not only is that more painful, but it permits the chi that you send down the flogger to most efficiently slam into her field. Think of the end of each fall as a point of light and each of those points blasting on her as they make contact.

So it is time to practice with your flogger on the pillow. Remember that a flogger uses centrifugal force to work. It is an extension of your arm and when you swing, get that flogger to extend in a straight line along your arm. Not only is this for perfect aim, but when you do that, you can direct the tips of the falls to their target. That is the easy part.

Your next step is to visualize the chi flowing through your arm out through the flogger to the ends of the falls. Again, the flogger is an extension of your arm and when the tips

strike the submissive, that energy will flow out through the flogger into her, penetrating her outer energy field and going directly into her system.

When you do this, you are not merely flogging her body. You are flogging her very soul.

Now let us go back to an earlier chapter where I describe the use of the headlamp in play. Remember the scenario. Your submissive is tied naked to a chair and you are sitting across from her wearing the headlamp.

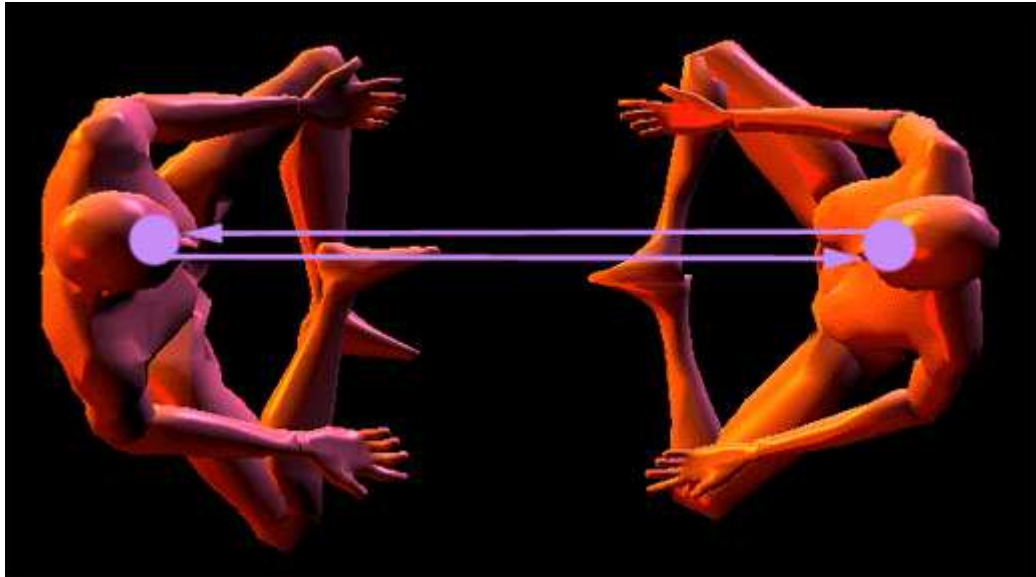

Ok, you are not going to look like this picture but it gives you an idea of what is going on, only the arrow will only be going one way, from you to her.

Sit and relax, give yourself a charge up. Now, turn on the headlamp and create a flow of energy down from the top of your head, back up through your spine to your brow chakra. Feel that energy flowing out and being directed by the beam of the headlamp, which will act as a carrier wave. That energy will impact any chakra on your submissive that you aim it at. Do nothing else at this time. Just keep pouring the energy into your submissive and watch her react. She will feel it.

While doing this, combine the headlamp and the hand resonator. Aim the headlamp at her brow chakra and the resonator between her legs. That will set up a flow of energy inside her and she will respond accordingly and everyone else in the dungeon will wonder what planet they have landed on because they will never figure out what the hell you are doing.

One other thing to try if you are in an active play space and that is to use "the intoxication of the others." In this case, you do not charge yourself so much as you

open yourself up as a channel for the energy of the space, drawing it through you and directing it by the beam of the headlamp into the body of your submissive.

XV

Erotic Touch

Many years ago I made the acquaintance of a one of the most delightful people in the world, Dora Kunz who by that time was somewhat elderly and highly eccentric. She was also the then President of the U. S. section of the Theosophical Society out of Adyar and the creator of Therapeutic Touch, a healing technique where the healer uses the interface of the energy field of her hands with the energy field of the subject. Now, as all my readers know, healing is not my specialty. In fact I hate doing it. First, I don't like healing people and second, it means if I have to do it then someone close to me is sick. Sickness is for strangers.

Anyway, in spite of my distaste for such things, Dora was such a wonderful, fun person to listen to that whenever she gave a talk I went to hear her, if only to see if she would have her clothes on straight. (One time she was almost going to give a lecture with her dress inside out and the librarian had to sort of shanghai her and get her put together properly.) As Therapeutic Touch was her favorite subject, naturally I got a healthy dose of it and Dora being the "hands on" speaker that she was, I ended up learning how to do it, at least the basics.

If Dora could see what I have done with her discovery she would spin in her urn!

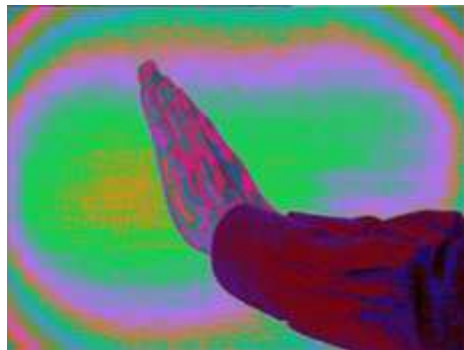

Let us start by going back to the part about the energy field around the hands. If you take one hand and pass it a couple of inches over the back of the other, or over your arm, you will notice that there is a feeling of heat. This is normal and the natural result of the fields touching each other. If you were to do this over a sick person you would discover a great deal of heat coming off the affected part of the body. This is the result of your field encountering the increased energy that the other person's body is putting into the diseased area to try to heal it. One time, when a friend of mine had breast cancer, I put my hand over her back and nearly burned myself. It was that hot!

The person who is on the other end of this will also feel heat. That is what we are aiming for.

Now, if you move your hand back and forth along the person, you will manipulate that person's field. This is what produces the healing effect. These movements can get a bit complicated as you get used to the different types of feeling you get while you do it and there is no need to go into that kind of detail here for our purposes.

The first time I used this in a play space was not in play. A friend had a bad case of bronchitis and was really uncomfortable. She had not been able to sleep well because whenever she lay down she had a terrible coughing attack. So I just sort of got behind her and began to work on her lungs, to the great annoyance of the local wiccan who thought that SHE was the chief healer. And to the surprise of my friend, it worked, rather dramatically, which also surprised me.

Then it just sort of lay fallow for a time until I learned about pain causing the human energy field to expand. It was time for an experiment.

I figured that if the field were expanded, then it should be more responsive than usual to the sort of thing that made Therapeutic Touch work. So one night after giving my submissive a good flogging while bent over a bench, I began to run my hands over her about three inches over her bare skin. The effect was dramatic. At certain points, she would actually jump in her bonds and she, being blindfolded, had no idea what it was that I was doing to her.

It was great fun.

So, to make this simple, here is what you do.

Begin by practicing running your hands around your arms, chest and face. Get yourself used to feeling the energy of your own body. If you have an ache and you can reach it, hold the palm of one hand over the part of the body, about one to three inches away from the skin. Do not touch the skin. Let the heat of the field sort of penetrate and see what happens. Most of the time the ache will go away. But the important thing is to get used to the feeling of heat.

In play, tie your submissive with as much of her available to you as possible. If you can have her standing in an open frame or with her hands tied over her head in the center of a room, so much the better. Blindfold her.

Now, repeat the procedure on her. Slowly move your hands over and around her, feeling the heat, without touching her skin. At certain points, stop and just let the heat from the fields sink into her. Watch how she reacts. She will. Make a mental note of the places that she reacts to your hands for future reference.

Once you have done that, stand behind her and hold both hands over the base of her spine, right over the base chakra. Let the energy from your hands really interact with the energy of that chakra.

After you have done that for a few seconds to a minute, keep one hand over the chakra and slowly move the other hand up along her spine until you reach the top of her head. Hold your hands in place there and watch her squirm.

Now move to the front of her and hold your hands over her breasts. Let the heat sink in and then move them down between her legs. Watch her reaction. With some practice you can really send her flying without even touching her.

Now repeat the procedure with the hand resonator in one hand and the other hand just using the field. The effect of that combination is nothing less than dramatic. With time, the response can actually become Pavlovian and she will orgasm with just the field interaction between her legs.

And when you do this at a large event, expect the poor Dungeon Guardians to be very confused. Which is, of course, more than half the fun of doing it.

The benefits of this technique are numerous. You do not have to carry lots of toys with you, in fact you do not need any toys at all. And once you have your submissive trained in this way, you can set her off anywhere, from a distance of a few feet to across the room. And you can do it without the trouble of a remote-controlled vibrator. All you need do is point your fingers at her and let the energy field do the rest.

I'm sorry Dora. What you discovered is just too good to be wasted on healing.

XVI

Psi Ball Play

Psi balls are not what you think they are. They are thoughtforms created in the shape of a ball and thrown with the intent of bursting on the target. They are intended to be transitory and when properly made can give quite a kick. It is possible to knock a person over with one if you pack it with enough power.



Get the idea?

You sit or stand across the room from your submissive and create the ball by holding your hands a few inches apart, about the level of your mid-section, slightly cupped. Now you focus the energy from your pelvic chakra into the space between the hands

and form it into the shape of a ball, sort of like making a snowball just like I described earlier in the chapter on thoughtforms.



As you do this, you will feel the heat build up in the seemingly empty space between your hands and there will be an actual pressure that you will feel as you form the ball. Keep this up for a time until you have a good, powerful thoughtform of pure sexual energy and then literally throw it like a baseball at your submissive's pelvic chakra. It will hit and explode and you will see the results immediately as the energy from the bursting thoughtform shoots into her etheric body and sets off all manner of interesting feelings.

This is another good trick to make the dungeon audience shake their heads in amazement. It will also make your submissive wonder what it was you just did. It is also a good way to deal with annoying Dungeon Monitor-Pests. All you do is create a psi ball that will make them very uncomfortable, like maybe sick to their stomachs, and fire it at them. They will leave rather quickly, with any luck running off to throw up somewhere.

And, of course, with this you are not limited to your own partner. Remember, with Psionics, everyone is fair game. So let us say that you are sitting in the dungeon bored out of your mind. It is just one of those nights when your submissive has to stay home because it is her weekend to have the kids and you just don't see anyone you want to play with. And the play is boring as virtue itself with just the usual goose-floggings (gooseflog, verb, to make goose noises with the flogger, whack whack, whack whack). You need to liven things up.

Remember the trick from the nightclub? Create a thoughtform and fire it at one of the subs, only this time you want to dry her up and decrease her pain tolerance. Then you make a second one to decrease patience and fire it at her dom. Keep making psi balls to do those things, firing them off at the couple, one after the other until you see the results. And with any luck the results will make the evening worth the price of admission!

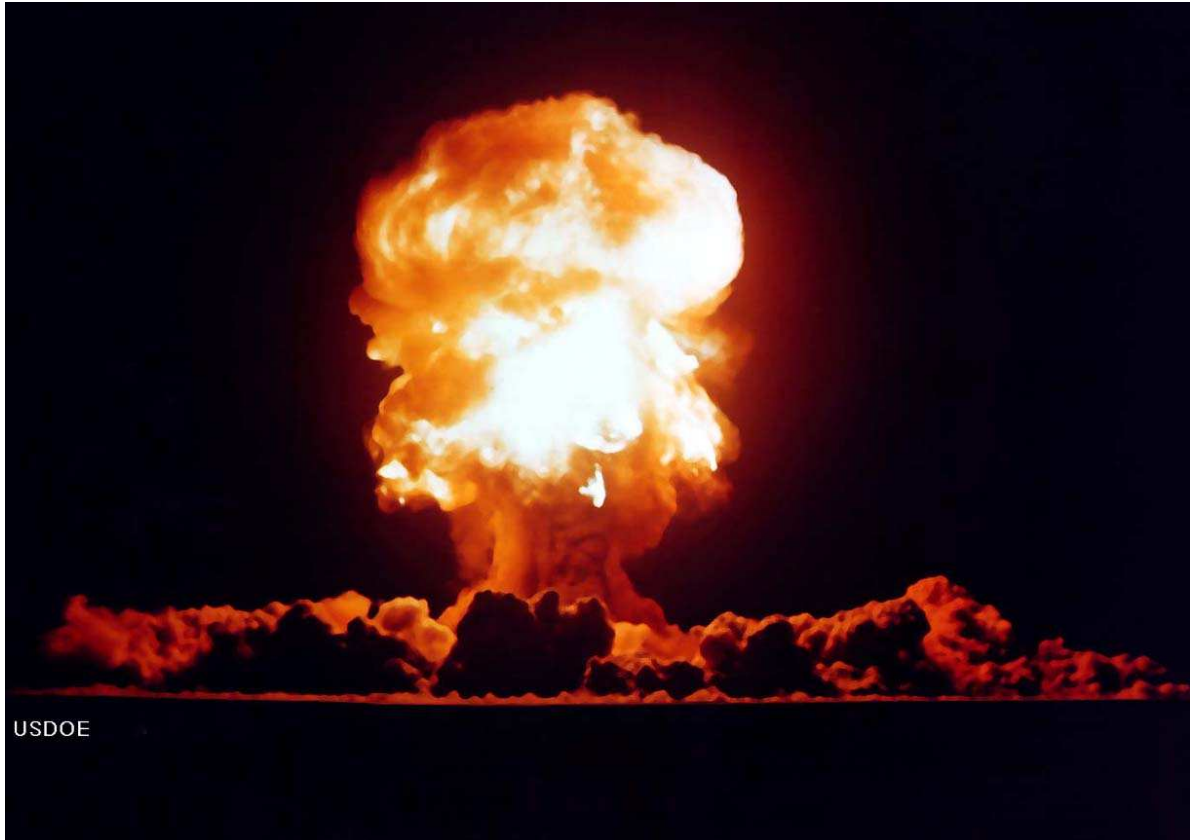

Ok, maybe not as much fun as this...

But the important thing to remember is when you use Psionics, there are no limits, there are no safewords and everyone is a potential victim, and you can play with all humanity whether they want to be played with or not.

Afterword

This pretty much covers the basics. I'm sure you can think of things that I have left out and no doubt you will think of things that I never dreamt of. But I think I should conclude by explaining why I have written this work in the first place so there will be no confusion.

My ideas here are beyond controversial. There are those who will find them, and me, terrifying if not insane. That is par for the course. It cannot be avoided. We have too much avoidance in our lifestyle as it is and it has served us ill.

And cowardice has served us ill.

I'm sick of the way we are bombarded by do-gooders and wimps who would have us do nothing but worry about what we do and be paralyzed with the fear of how outsiders may view us. I'm sick of it and I'm disgusted by that belief and by those who hold to that view. We do not have to be afraid. If the "good people" disapprove of us, let them move! They will be happier, and healthier, somewhere else.

We tried being nice. And we can see where it has gotten us. So let there be an end to niceness. Let us become creatures of nightmare and let those nightmares beset those who think that they can oppose us. We are people who torture other people for the fun of. We are not people that the old biddies want mad at them, or their families.

So let there be no more Safety. Let us have done with the very word!

Let there be no more pretensions of Sanity.

And let us finally, once and for all, put an end to the illusion of Consent!

And to those who say, "What will this do to our Community?" I say, "To Hell with the damned community! We will not be controlled by your fears." And we will rampage across the land as the barbarians that we are, fearless and joyful, uncontrolled and uncontrollable, accounting to none and answering to none.

We will finally recognize that all these concerns that people try to foist upon us are nothing more than another species of Sacred Cow and sacred cows, do, in fact, make the best hamburger. We will cast them aside, ignore those who would try to impose them, and finally, at long last, be free.

Psionics can do that. Psionics will do that.

I am

Uncle Chuckie--the Dagger Dom